



MASTERTEC

SPECIAL ARTICLES FOR REINFORCED CONCRETE CONSTRUCTION



2024/2025

PRODUCT RANGE



MASTERTEC

SPECIAL ARTICLES FOR REINFORCED CONCRETE CONSTRUCTION

MASTERTEC – a family business, now being run by its second generation

MASTERTEC is based in Oberhaid, 10 km from the famous UNESCO world heritage city of Bamberg. The family business was founded in 1998 by Rainer and Gabriele Kropfelder. Over the years, the number of employees has grown to over 50. Sons Felix and Jakob are taking on more and more responsibility for the further development of the company.

Working together with employees, customers and suppliers as equals, open dialogue and mutual respect have all contributed greatly to the positive development of the company.

Our products are used in the fields of waterproofing for joints and penetrations in reinforced concrete construction, earthing and lightning protection, and formwork accessories.



Over the last 25 years, we have developed many products which provide

additional safety for all construction sites in many countries. Comprehensive testing at different renowned testing institutes guarantees the functionality of our technologies.

Over the years, we have found distributors, sales partners and friends in 35 different countries, all of whom have supported us for a long time with their professional knowledge and have contributed greatly to the development of MASTERTEC.

The MASTERTEC team would like to say thank you, and we look forward to continuing to work together with you.

You can contact us

Monday – Thursday

7:15 am – 12:00 pm

12:45 – 4:30 pm

Friday

7:15 am – 12:00 pm

12:45 – 3:00 pm

25 years of MASTERTEC

- Founding year:** 1998
- Employees:** 50
- Storage and logistics:** Approx. 7000 m² of storage and production area, 5000 pallet slots
- Target markets:** Europe and growing export to non-European countries
- In-house:** Development and construction, production and assembly, quality assurance, training

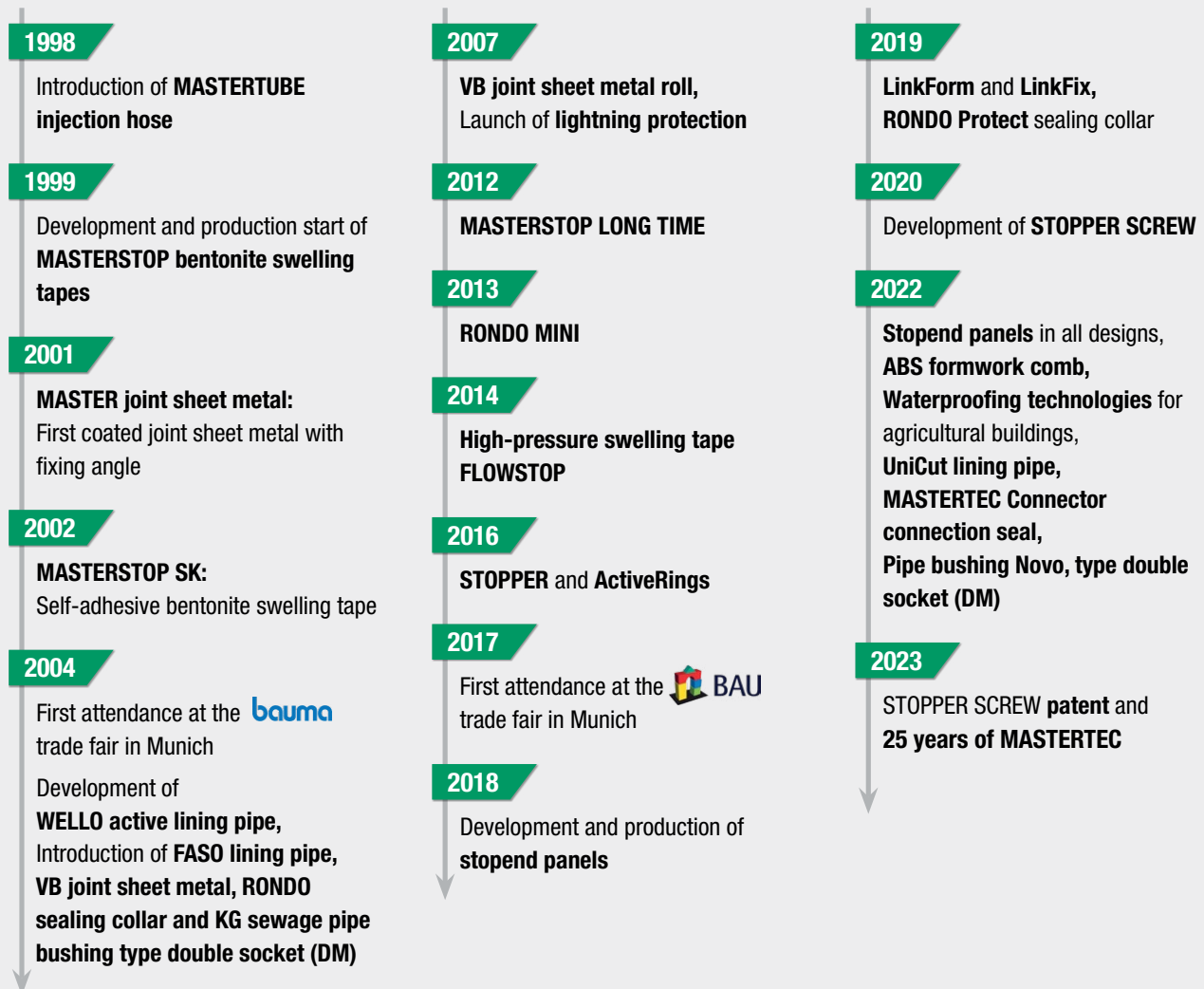

Follow us on social media

Parallel to our website and our newsletters, we use all social media channels to keep you informed on our new product releases and current issues at MASTERTEC. Join our online community and keep up-to-date at all times.

Instagram



www.instagram.com/mastertec.eu

YouTube



www.youtube.com/@masterteceu

Facebook



www.facebook.com/MASTERTEC.eu

LinkedIn



www.linkedin.com/company/masterteceu

Why should you follow MASTERTEC?

- Never miss the launch of new products again. We inform you quickly and reliably about our innovations.
- Benefit from our tips and tricks in relation to our range and how it can be used.
- Receive insights from behind the scenes and get to know our dedicated team.
- Get in touch with us using the platform of your choice. Our team can draw on many years of experience to find the right solution even for your specific problem.

If you would like to keep up-to-date at all times, simply scan a QR code from this page and follow the MASTERTEC channel you have selected. We look forward to welcoming you to our online community and getting in touch with you.

Service platforms

AUSSCHREIBEN .DE



MASTERTEC can also be found on the leading service platforms of the construction sector. This is where you will find the right answers if you are preparing invitations to tender, researching product information or if you would like information on the sustainability of our range.



Building
Material
Scout

Product safety

Our products are certified by testing institutes for the various areas of application.

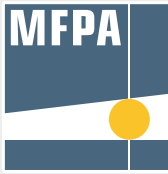

IAF - Radioökologie GmbH

Labor für Radionuklidanalytik
Radiologische Gutachten
Consulting



DBI - Gastechnologisches
Institut gGmbH Freiberg



We are a member

From involvement in the compilation of standards for the construction of lightning protection systems, to conducting seminars and workshops and systematic public education, the association makes a major contribution to personal safety and the protection of objects of material value. This service is provided thanks to the voluntary activity of its members.



The technical and academic association of the German construction industry is dedicated to the primary issues of construction technology and its further development within German and European networks. It promotes academia and research with construction consultations, events, publications and committee work.



Interactive price list

The PDF version of our price list features an interactive design. You can click on an article number to directly call up detailed product information for the selected product on our website. This is where you will find comprehensive technical data, product information, installation instructions, product videos and .dwg files.

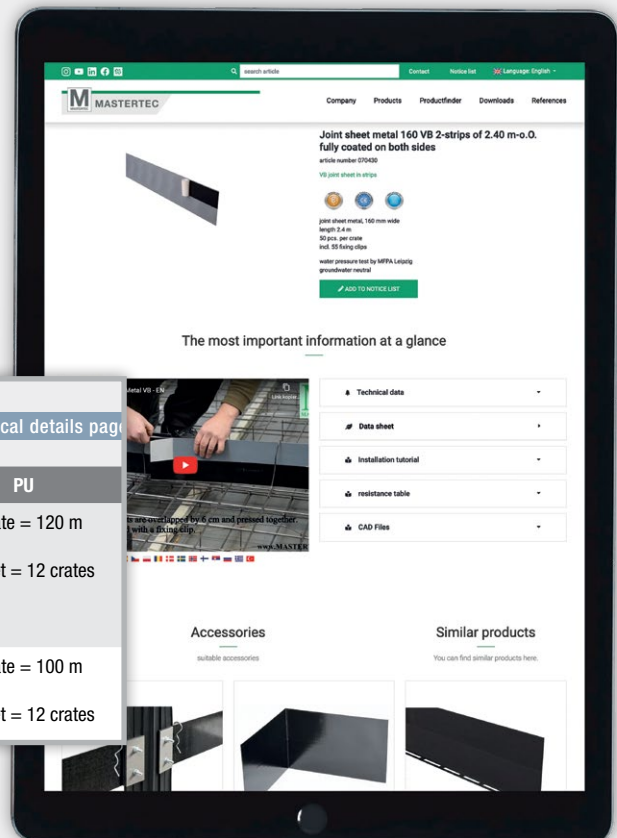

VB joint sheet metal strips		Technical details page
Art. no.	Description	PU
NEW! 070430	VB joint sheet metal in crate Length 2.4 m, height 160 mm, 1 crate = 120 m (50 strips of 2.4 m each), fully coated on both sides, incl. 55 fixing clips	1 crate = 120 m 1 pallet = 12 crates
NEW! 070432	VB joint sheet metal in crate Length 2.0 m, height 160 mm, 1 crate = 100 m (50 strips of 2 m each), fully coated on both sides	1 crate = 100 m 1 pallet = 12 crates



MASTERTEC PRODUCT RANGE

PRODUCT GROUP

1

Swelling tapes

- Bentonite swelling tapes
- Self-adhesive swelling tape
- High-pressure swelling tapes
- Swelling pastes
- Adhesives
- Grids

pages 9 – 24



PRODUCT GROUP

2

Joint sheet metals

- Coated joint sheet metals
- Crack-inducing profiles
- Uncoated joint sheet metals
- Joint tapes
- Connectors
- Rib laths
- Formwork systems+ accessories

pages 25 – 88

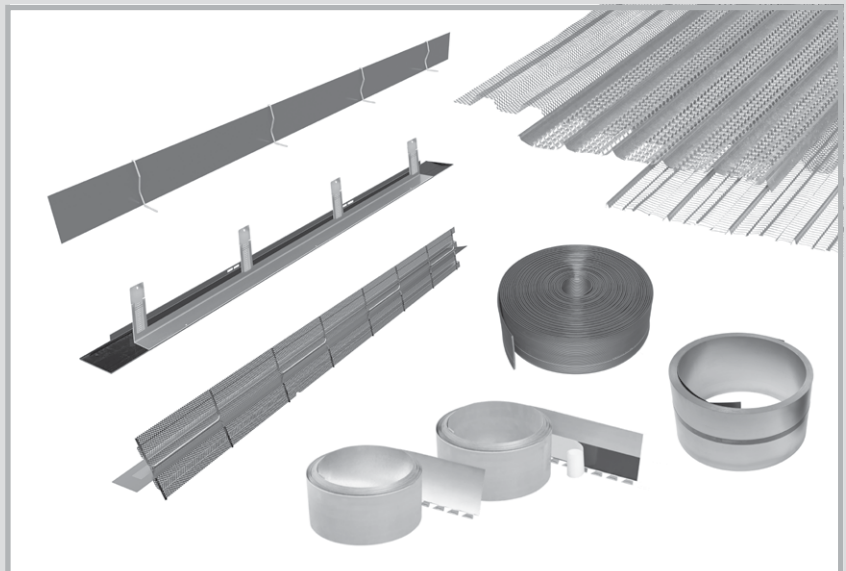

PRODUCT GROUP

3

Injection hoses Construction chemistry

- Injection hoses
- Accessories for injection hoses
- Injection packers
- Injection resins
- Concrete adhesives
- Concrete release agents

pages 89 – 98



MASTERTEC PRODUCT RANGE

PRODUCT GROUP

Pressure water-tight service ducts

4

- Formwork aids
- Service duct system
- Lining pipes
- Gasket inserts
- Sealing compound
- Sealing collars
- Pipe bushings
- Ground drains

pages 99 – 142



PRODUCT GROUP

Lightning protection

5

- Lightning protection conductors
- Connectors
- Connecting clamps
- Fixed earthing terminals
- Wall bushings
- Earth rods

pages 143 – 166

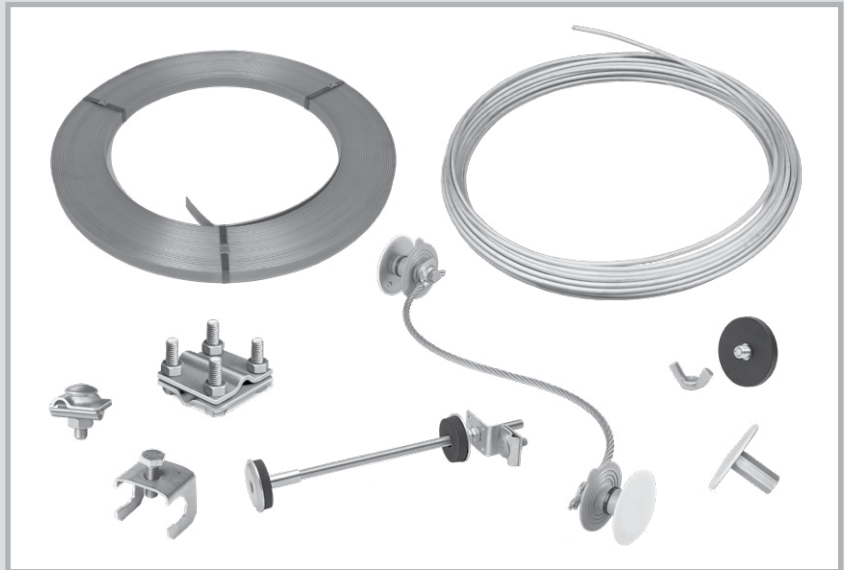

PRODUCT GROUP

Formwork accessories

6

- Sealing plugs
- Sealing of formwork tie points
- Corrugated bearings
- Impact sound insulation/ bearings
- Adhesive tapes
- Damp proof courses

pages 167 – 183

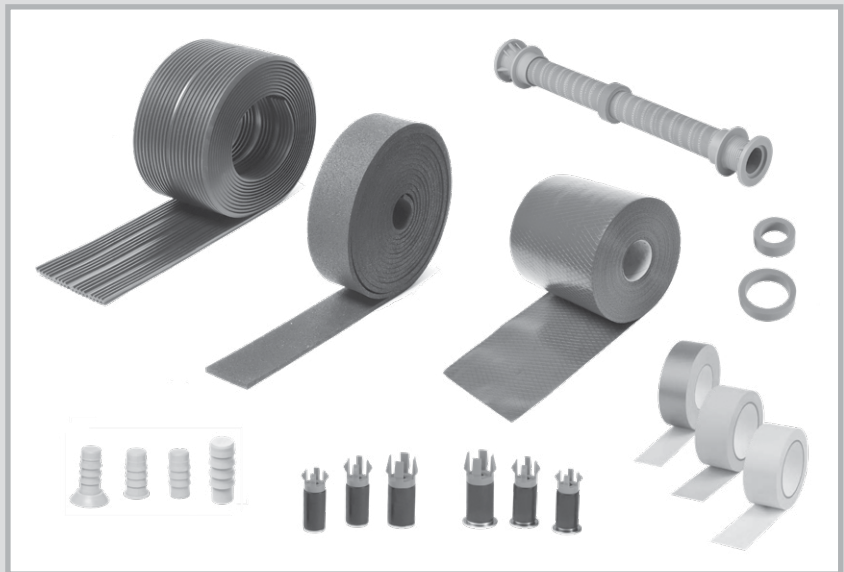

Our pictograms

In many places in this catalogue, you will find various pictograms. This is a brief overview of their meanings:



Testing of impermeability to pressurised water



Testing of the impact sound reduction based on DIN EN ISO 140-8



Testing of fire resistance class according to DIN EN 13501-2 and construction materials class according to DIN EN 13501-1 and DIN 4102-1



Testing of the maximum static load



Testing of resistance to various media



Testing of the lightning current carrying capacity class according to DIN EN 62561-1



Standard sound level differential testing to DIN EN ISO 10140-2



Compliance with the European requirements for construction technology



Approved by the building authorities for storage and filling facilities of slurry/liquid manure/silage effluent and biogas facilities



Compliance with a European harmonised standard



Testing of impermeability to the naturally-occurring radioactive inert gas Radon

Technology

For products which feature this pictogram, you will find further technical information on the specified page.

You will find additional information, such as technical data sheets, installation videos, installation instructions and dwg files on our website at www.mastertec.eu

SWELLING TAPES



MASTERSTOP
Bentonite swelling tape
page 10

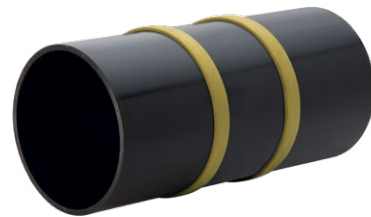

MASTERSTOP SK
Self-adhesive
bentonite swelling tape
page 11

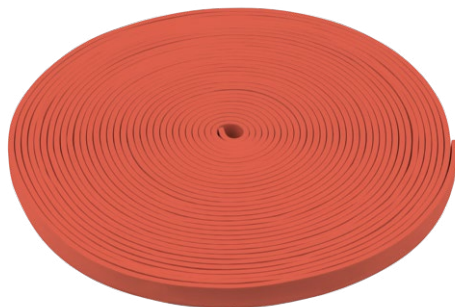
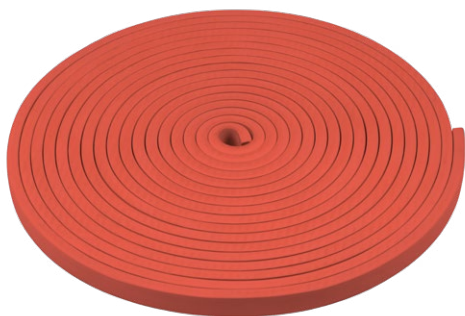

FLOWSTOP
High-pressure swelling tape
page 11

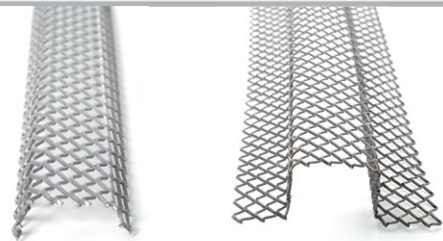

Accessories for swelling tapes
pages 12 – 13

SWELLING TAPES

MASTERSTOP bentonite swelling tapes

for the waterproofing of construction joints Technical details pages 14 – 17



Art. no.	Description	PU	Secondary packaging	Weight per carton
010011	MASTERSTOP bentonite swelling tape Size: 25 x 20 mm, colour: black, Carton 30 m (6 rolls of 5 m each), Pressure-tight up to 80 m water column on rough and smooth surfaces (For technical details see page 14)	1 carton	1 pallet = 36 cartons	22.65 kg
010012	MASTERSTOP LONG TIME Bentonite swelling tape with protective film, Size: 25 x 20 mm, colour: black, Carton 30 m (6 rolls of 5 m each), Pressure-tight up to 50 m water column	1 carton	1 pallet = 36 cartons	23.20 kg
010020	MASTERSTOP bentonite swelling tape Size: 20 x 15 mm, colour: green, Carton 30 m (6 rolls of 5 m each), Pressure-tight up to 20 m water column	1 carton	1 pallet = 36 cartons	13.95 kg

Art. no. 010011



Art. no. 010012



Art. no. 010020



MASTERSTOP bentonite swelling tapes

for subordinate waterproofing

Art.Gr.
110

Art. no.	Description	PU	Secondary packaging	Weight per carton
010016	MASTERSTOP bentonite swelling tape Size: 15 x 10 mm, colour: black, Carton 90 m (9 rolls of 10 m each)	1 carton	1 pallet = 36 cartons	21.80 kg
010017	MASTERSTOP bentonite swelling tape Size: 20 x 10 mm, colour: black, Carton 54 m (9 rolls of 6 m each)	1 carton	1 pallet = 36 cartons	16.90 kg

Art. no. 010016



Art. no. 010017



MASTERSTOP SK



Self-adhesive bentonite swelling tape [Technical details page 18](#)

Art.Gr. 101

Art. no.	Description	PU	Secondary packaging	Weight per carton
010025	MASTERSTOP SK Size: 20 x 5 mm, self-adhesive, Carton 90 m (5 rolls of 18 m each), Pressure-tight up to 50 m water column	1 carton	1 pallet = 36 cartons	14.95 kg



FLOWSTOP



High-pressure TPE swelling tapes for waterproofing of construction joints [Technical details pages 19 – 21](#)

Art.Gr. 102

Art. no.	Description	PU	Secondary packaging	Weight per carton
010040	FLOWSTOP Size: 20 x 5 mm, Carton 120 m (6 rolls of 20 m each), Pressure-tight up to 80 m water column	1 carton	1 pallet = 36 cartons	19.60 kg
010045	FLOWSTOP Size: 20 x 10 mm, Carton 60 m (6 rolls of 10 m each), Pressure-tight up to 80 m water column	1 carton	1 pallet = 36 cartons	17.80 kg

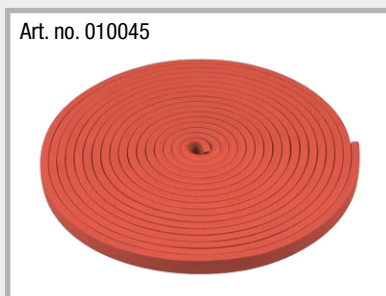
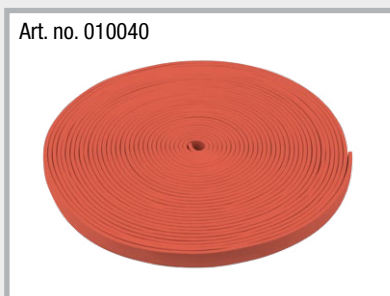

FLOWSTOP is fixed using POWER swelling tape adhesive.

Suitable installation accessories such as swelling tape adhesive and grids can be found on pages 12/13.

Adhesives and swelling paste

Technical details pages 22 – 24

Art.Gr.
103

Art. no.	Description	PU	Secondary packaging	Weight per carton
010050	Swelling tape adhesive for bentonite swelling tape Cartridge 310 ml Usage: 1 cartridge = approx. 7 m suitable for damp substructures	1 pc.	1 carton = 20 cartridges	11.00 kg
010052	POWER swelling tape adhesive High-pressure adhesive for fixing MASTERSTOP and FLOWSTOP swelling tapes or for fixing the foil flange, Cartridge 310 ml, Usage: 1 cartridge = approx. 7 m, suitable for damp substructures	1 pc.	1 carton = 20 cartridges	9.80 kg
010030	MasterMastic PU swelling paste  Polyurethane-based swelling paste, for waterproofing construction joints (20 m water column) and penetrations (40 m water column) or for fixing swelling tapes, Cartridge: 310 ml, Usage: Construction joint approx. 300-350 ml/m Usage: Penetration approx. 80-100 ml/m Usage: Fixing swelling tape approx. 45-50 ml/m	1 pc.	1 carton = 12 cartridges	5.65 kg



The POWER swelling tape adhesive can do more in construction:

- Very good adhesion to many substrates
- Bonding of stone, natural stone and ceramics
- Bonding and mounting of all kinds of different materials, such as wood, wood materials, plastics and metals
- Extremely water-resistant – for bonds with high water load
- Paintable
- Free from silicone and isocyanate

Fastening grids

Art.Gr.
105

Art. no.	Description	PU	Secondary packaging	Weight per carton
010060	Universal swelling tape grid for bentonite swelling tapes 25 x 20 mm and 20 x 15 mm, Carton 30 m (30 grids of 1 m each)	1 carton	1 pallet = 250 cartons	2.40 kg
010065	Swelling tape grid for MASTERSTOP LONG TIME 25 x 20 mm, Carton 30 m (30 grids of 1 m each)	1 carton	1 pallet = 99 cartons	5.50 kg

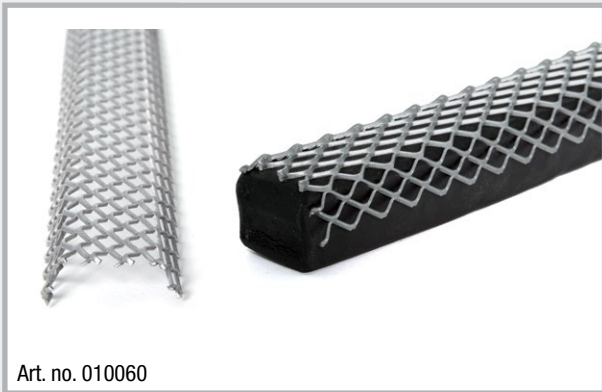

Art. no. 010060



Art. no. 010065

Fastening nails

Art.Gr.
106

Art. no.	Description	PU	Weight
010080	Nails for bolt-firing tool Length: 42 mm with big washer	1 bag of 100 pcs.	1.10 kg per bag
010090	Nails for manual fastening Length: 40 mm with washer	1 carton of 250 pcs.	0.95 kg per carton



Art. no. 010080



Art. no. 010090



Art. no. 010080

Art. no. 010090

Place the swelling tape grid over the MASTERSTOP bentonite swelling tape and fasten to the concrete with nails. Nailing can be performed manually or with a bolt-firing tool. The spacing between the nails must not exceed 20 cm.

MASTERSTOP bentonite swelling tapes



- European Technical Assessment ETA
- General Building Supervisory Test Certificate (abP) for smooth and rough construction joints
- Standard test 50 m water column with swelling tape adhesive
- High pressure testing for smooth and rough construction joints with water column up to 80 m. In this case, POWER swelling tape adhesive or MasterMastic PU swelling paste must be used for fastening.
- Complies with the directive for water-impermeable structures. Wear classes 1 + 2: continuously or periodically pressurised water or soil moisture and utility class A + B

Product description

MASTERSTOP bentonite swelling tapes have a proven track record which goes back many years in construction practise. They swell upon contact with water and seal cracks or construction joints reliably and permanently. The test certificates confirm the product's suitability for various applications.

The convincing advantages of MASTERSTOP bentonite swelling tapes

- Produced with high-grade sodium bentonite
- Easy and safe installation
- No foundation curb
- Self-injecting effect: the swelling tape components penetrate cracks and cavities
- Environmentally friendly
- No fittings or welding
- Swelling and shrinking process is reversible
- Dimensionally stable and not sticky
- No cuttings or oddments
- Safety proved by extensive testing

Resistances of MASTERSTOP bentonite swelling tapes and MASTERSTOP SK

Medium	resistant	not resistant
Alkalis in general	✓	
Urea	✓	
Liquid manure/slurry	✓	
Biogas	✓	
Radon	✓	
De-icing salt	✓	
Substances obtained by means of composting	✓	
Petrol		✓
Diesel		✓
Heating oil		✓

Further resistances are available on request.

Installation

MASTERSTOP bentonite swelling tapes are fixed with a swelling tape grid, swelling tape adhesive or with MasterMastic PU swelling paste. They are laid inside the reinforcement with a concrete cover of at least 8 cm.



Installation with fastening grid and nails

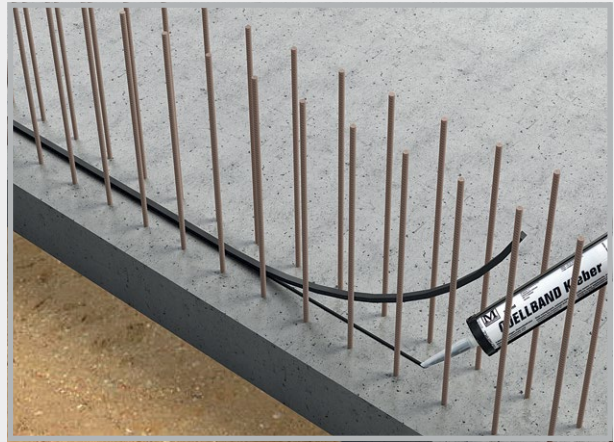

Installation with swelling tape adhesive

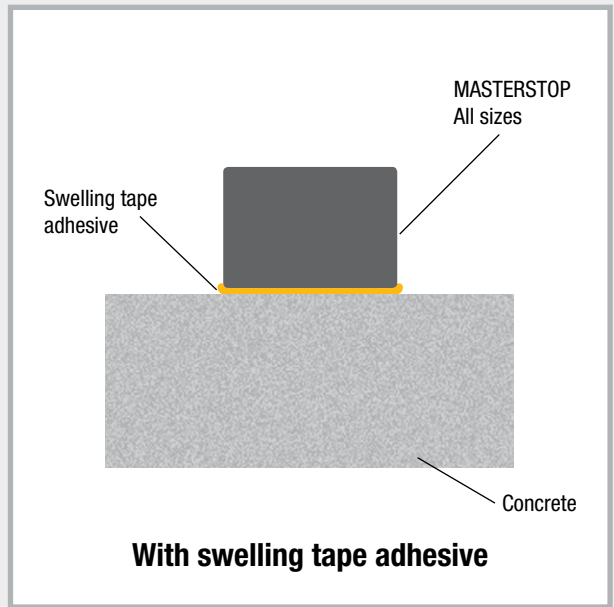
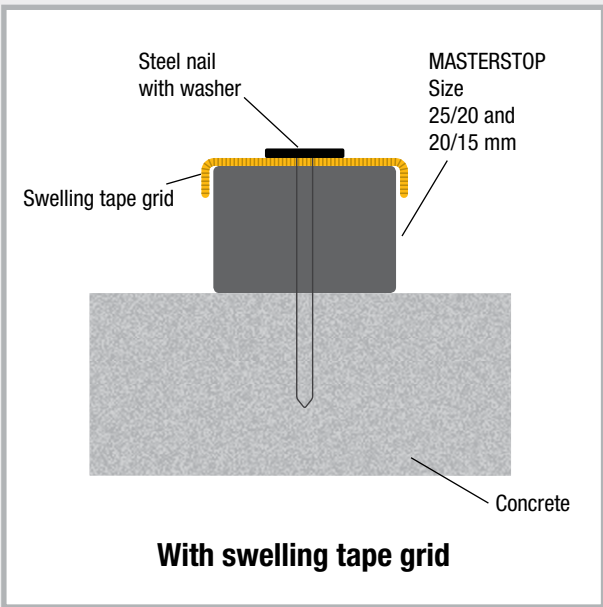

Laying

Size 25/20 mm

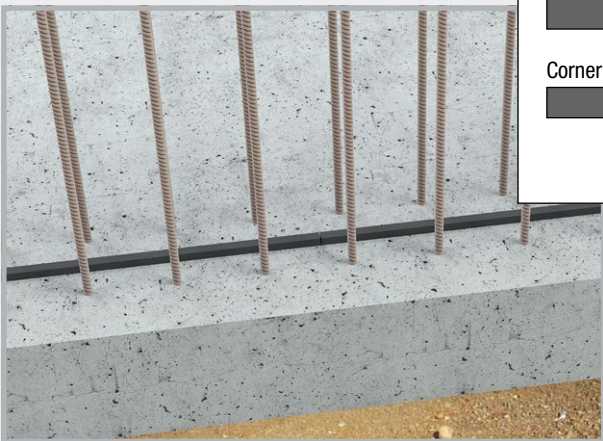

Straight butt joint

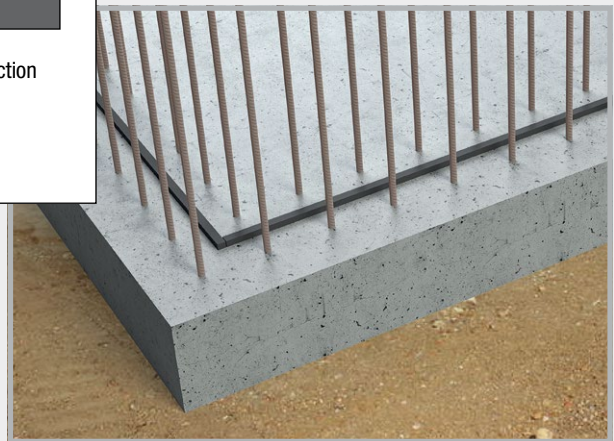
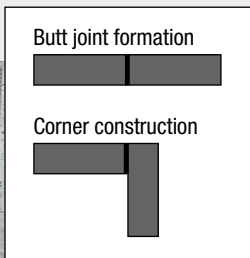

Corner butt joint

MASTERSTOP LONG TIME

All-weather bentonite swelling tape

Product description and function

MASTERSTOP LONG TIME 25 x 20 mm is a bentonite swelling tape for the waterproofing of foundation/foundation, foundation/wall and wall/wall construction joints.

MASTERSTOP LONG TIME is equipped with a protective film which enables installation in all kinds of weather.

The protective film ensures that the swelling tape can be exposed to rain and in-situ water for at least 10 days without expanding.

This changes when it is encased in concrete. The composition of the concrete causes the protective film to lose its effect after few days so that the swelling tape is set free and seals the joints safely and permanently in case of water ingress.

The tape is not suitable for installation underwater or long-term immersion in water.



Rain protection 10 days

Pressure-tight 50 m water column

Safety

MASTERSTOP LONG TIME is not a hazardous substance and is uncomplicated to use and handle.

Storage

MASTERSTOP LONG TIME must be stored in a dry place and protected from contamination and mechanical damage. Swelling tapes which have already started expanding as well as swelling tapes with an altered geometry or damaged protective film must not be installed.



Comparison of swelling tape with and without protective film

The convincing advantages of MASTERSTOP LONG TIME

- All-weather installation
- No foundation curb
- Self-injecting effect: the swelling tape components penetrate cracks and cavities
- Environmentally friendly
- No fittings or welding
- Swelling and shrinking process is reversible
- Dimensionally stable and not sticky
- No cuttings or oddments
- Safety proved by extensive testing

Installation

- MASTERSTOP LONG TIME is installed in the centre of the joint within the reinforcement.
- An adequate concrete cover of at least 8 cm must be ensured.
- The swelling tape cannot be glued and instead must be fixed to the substrate using a swelling tape grid. To ensure that the swelling tape lies flat on the concrete substrate, the grid usually needs to be fixed to the concrete using nails every 20 cm in the longitudinal direction. The distance between the nails can be reduced if necessary.
- Make sure that the protective film is not damaged.
- The tape ends are butt jointed. If tape sections are used, pull back the protective film, cut off approx. 5 cm of the swelling tape and turn down the film in order to prevent contact with water.
- The concrete substrate must be level and free of loose or separating particles and must not be excessively rough.

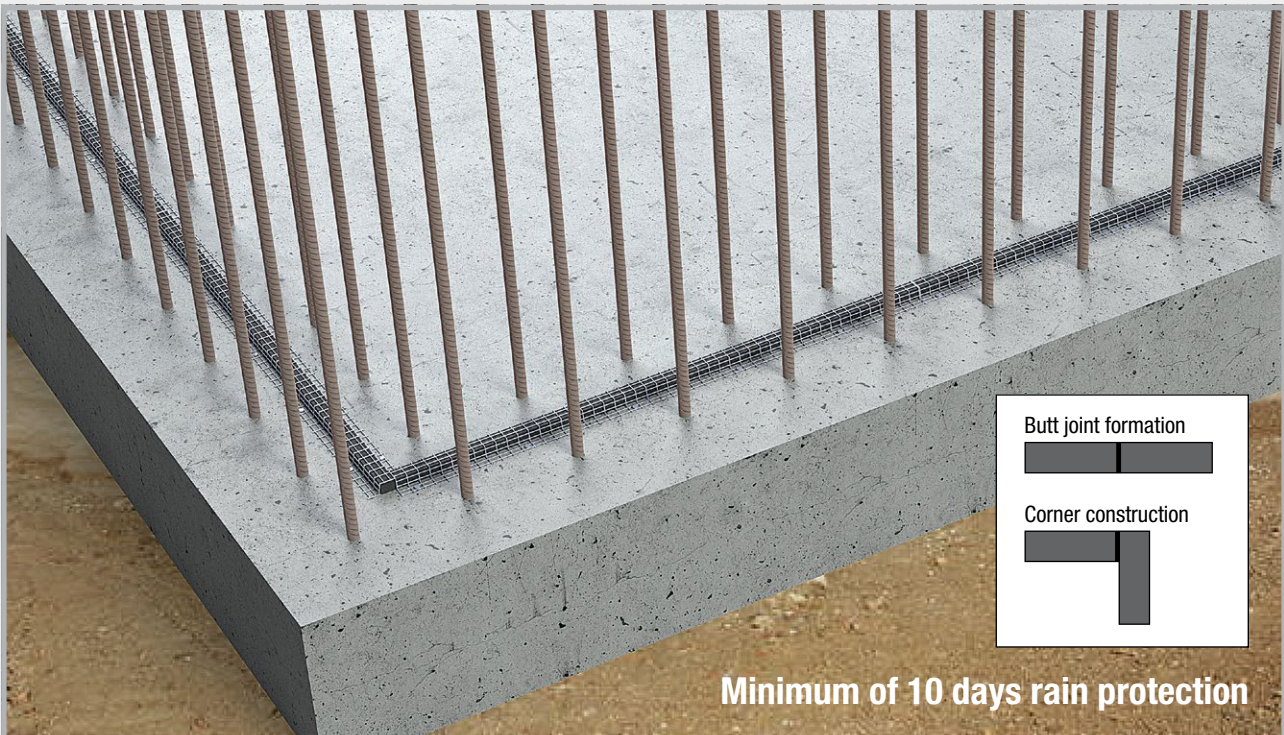
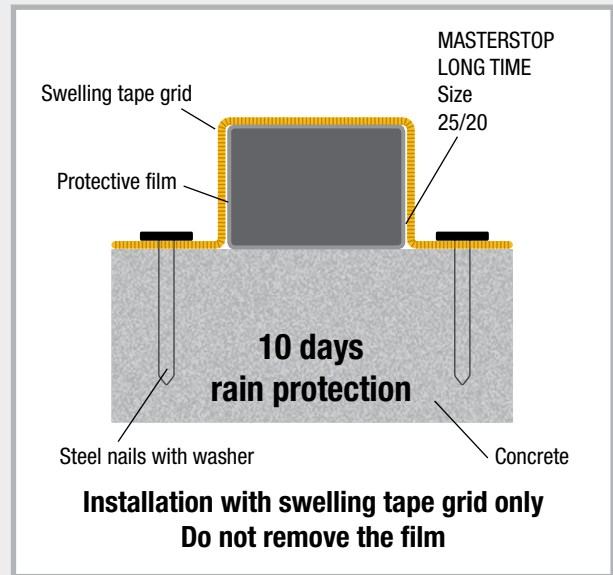

Installation of MASTERSTOP LONG TIME with swelling tape grid
8 cm concrete cover within reinforcement

MASTERSTOP SK

Self-adhesive bentonite swelling tape



Product description

MASTERSTOP SK is a self-adhesive bentonite swelling tape which expands on contact with water and prevents water penetration.

Testing

- Test report MFPA Leipzig, up to 50 m water column
- Environmentally friendly

Application

- Water-impermeable integration of pipe ducts in concrete buildings
- Waterproofing of reinforcement connections
- Waterproofing of ground drains

Installation

- Pull off silicone paper and affix 2 rings of MASTERSTOP SK around the pipe to be waterproofed.
- Butt joint ends, no overlaps
- The pipe surface must be rigid
- MASTERSTOP SK adheres to metal, plastic, PVC and stone.
- Secure MASTERSTOP SK with binding wire if necessary.

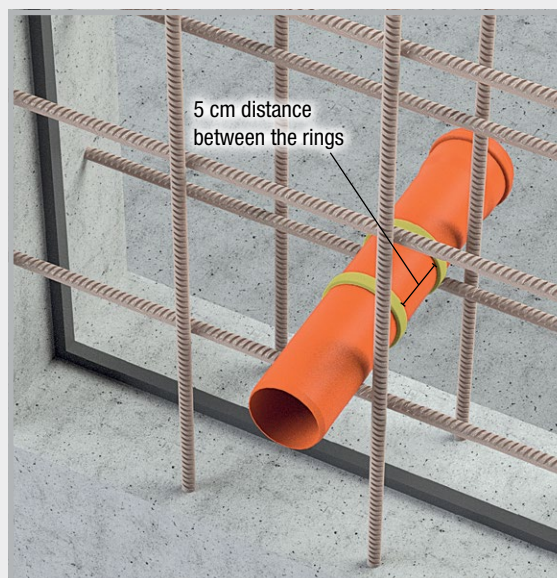
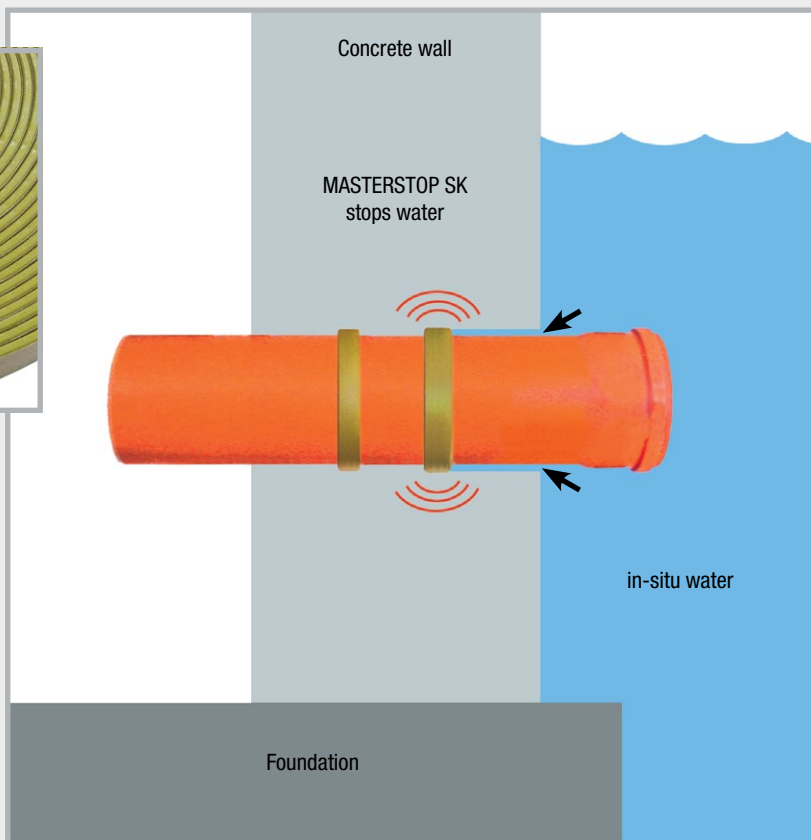

MASTERSTOP SK is affixed around the pipe inside the reinforcement with 6 cm concrete cover.

FLOWSTOP

High-pressure swelling tapes



Product description

For waterproofing construction joints and penetrations in concrete structures. With a proven ability to withstand the pressure of an 80 m water column, FLOWSTOP 20 x 5 mm meets the requirements of the German directive on water-impermeable concrete structures (WU Directive) for a continuous pressure of 2 bar, as well as international standards that require high pressure resistance.



- European Technical Assessment ETA
- General Building Supervisory Test Certificate
- Suitable for zones with frequently varying water levels
- Good chemical resistance
- Dimensionally stable

- Maximum pressure of 80 m water column with size 20 x 5 mm
- Long-term testing for more than 250 days
- Easy installation with POWER swelling tape adhesive
- No foundation curb required
- Chemical basis: Modified TPE
- Temperature range: -30°C to +60°C
- Storage: Dry and protected

Resistances of FLOWSTOP



Further resistances are available on request.

Medium	resistant
Soapy water	✓
Sodium hydroxide solution	✓
Caustic potash solution	✓
Liquid manure/slurry	✓
Mineral oil 15W-40	✓
Motor oil 0W-40	✓
Hydraulic oil HVL 46	✓
Salt water 3-4% NaCl	✓
Chlorinated water 0.95-1 mg/l	✓
Chlorinated water 10 mg/l (shock chlorination)	✓
Sodium carbonate	✓
Bitumen	✓

Installation

The substrate must be clean, dry and free of loose particles. Once the POWER swelling tape adhesive has been applied in the centre of the joint, the tape is placed on the adhesive and gently pressed in. A concrete cover of at least 8 cm inside the reinforcement must be ensured. Not suitable for installation with swelling tape grid. Prior to concreting the tape must not lie in water for an extended period. Rain water that runs off does not activate the swelling.

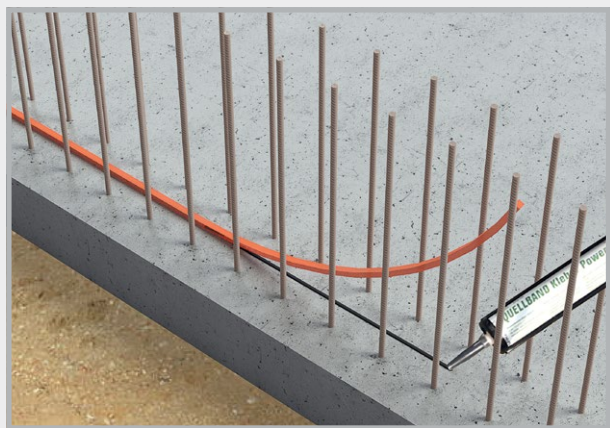
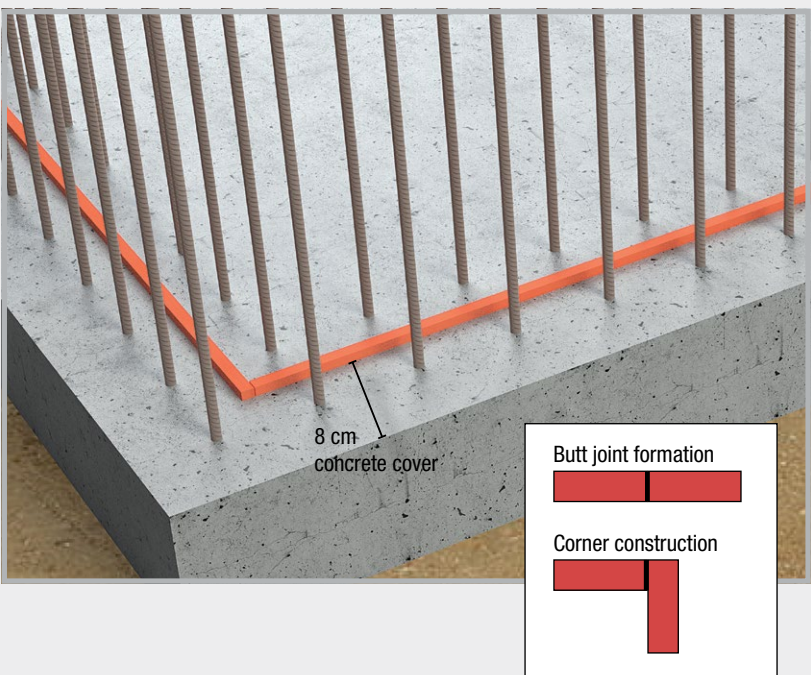

Spray on the POWER swelling tape adhesive and place the FLOWSTOP swelling tape on top of the adhesive.

Waterproofing of a construction joint

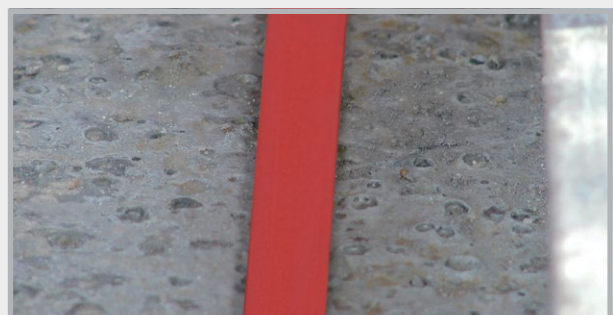
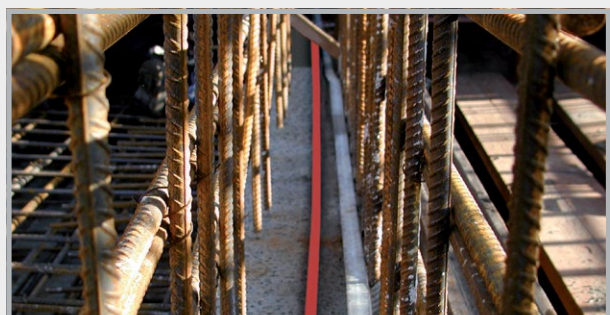

Swelling behaviour

The swelling behaviour of FLOWSTOP was tested over 180 days through immersion in 4 test liquids.

Test liquid	Maximum expansion in all test cycles
Neutral liquid with pH value 7	600%
Alkaline liquid with pH value 13	350%
Liquid aggressive to concrete with pH value 4.5	200%
Salt water	100%

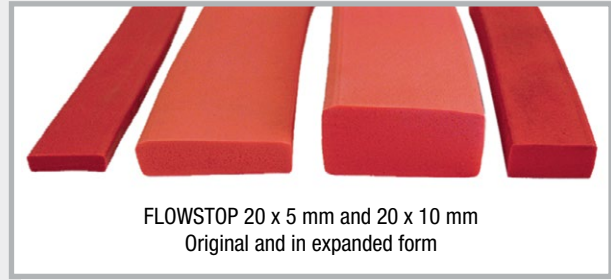

The final expansion was reached after 6 to 10 days, depending on the test liquid. These periods provide adequate time for secure installation.

FLOWSTOP test procedure

Water pressure [bar]	Test duration days	Water passage	Remarks
0.03	3	not measurable	Adjustment of the construction joint to 0.25 mm and water filling without pressure Water penetration from all sides, quickly reducing with increased swelling
0.2	1	0	Start of the first exposure to pressurised water
0.4	1	0	impermeable
0.6	1	0	impermeable
0.8	1	0	impermeable
1.0	3	0	impermeable
2.0	1	0	impermeable
3.0	1	0	impermeable
4.0	1	0	impermeable
5.0	14	0	impermeable
–	43	–	Six weeks of drying with hot air supply
0.03	3	0	Water filling without pressure, impermeable
0.2	1	0	Start of the second exposure to pressurised water, impermeable
0.4	1	0	impermeable
0.6	1	0	impermeable
0.8	1	0	impermeable

Water pressure [bar]	Test duration days	Water passage	Remarks
1.0	3	0	impermeable
2.0	1	0	impermeable
3.0	1	0	impermeable
4.0	1	0	impermeable
5.0	14	0	impermeable
–	43	–	Six weeks of drying with hot air supply
0.03	3	0	Water filling without pressure, impermeable
0.2	1	0	Start of the third exposure to pressurised water, impermeable
0.4	1	0	impermeable
0.6	1	0	impermeable
0.8	1	0	impermeable
1.0	3	0	impermeable
2.0	1	0	impermeable
3.0	1	0	impermeable
4.0	1	0	impermeable
5.0	14	0	impermeable
6.0	28	0	Additional pressure level, impermeable
7.0	28	0	Additional pressure level, impermeable
8.0	28	0	Additional pressure level, impermeable

Adhesives and swelling pastes

MASTERTEC produces adhesives for swelling tapes and swelling pastes for waterproofing various types and qualities of construction joints and wall penetrations.

Preparatory work

Cutting the cartridge tips

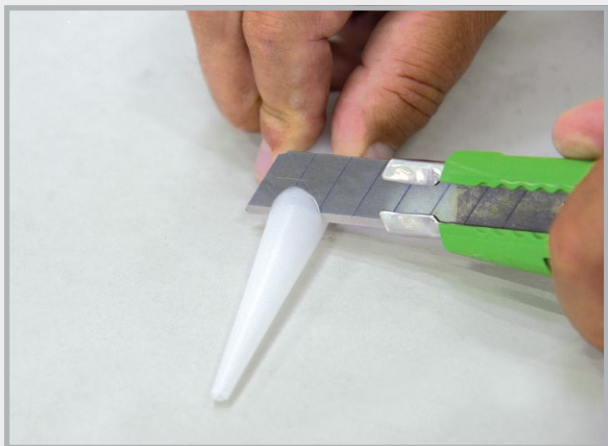

The nozzle is cut off to suit the various areas of application.

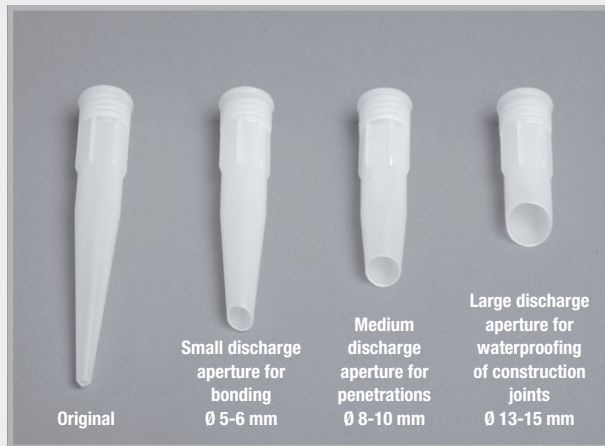

Cuts

Application of the adhesive or pastes



Example: Large discharge aperture
Usage approx. 280-360 ml/m

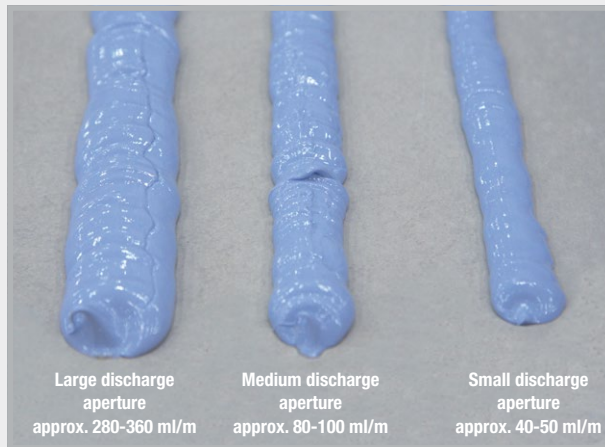

Swelling tape adhesive

Single-component, solvent-free sealant for bonding of MASTERSTOP bentonite swelling tapes.

Usage:	40-50 ml/m \triangleq approx. 7 m per cartridge
Application:	For dry and slightly moist substrates
Bonds with:	Concrete
Application temperature:	+5°C to +45°C
Thermal stability after curing:	-20°C to +70°C
Setting time:	approx. 8 hrs. at +20°C
Environmental aspects:	Once cured, the product is odourless and physiologically harmless.
Supplied as:	Cartridge 310 ml



Apply adhesive to clean substrate



Position the swelling tape

POWER swelling tape adhesive

Single-component solvent-free sealant for bonding of MASTERSTOP and FLOWSTOP swelling tapes or for fixing the foil flange. The POWER version is a high-pressure adhesive.

Usage:	40-50 ml/m = approx. 7 m per cartridge
Application:	for dry and damp substrates
Bonds with:	Concrete, steel, rigid PVC, soft PVC, stone Achieves a very high mechanical strength.
Application temperature:	+5°C to +45°C
Thermal stability after curing:	-30°C to +80°C
Setting time:	approx. 8 hrs. at +20°C
Environmental aspects:	Once cured, the product is odourless and physiologically harmless. Highly recommended environmentally compatible building product
Supplied as:	Cartridge 310 ml



Press the swelling tape into the adhesive bed



POWER high-pressure adhesive for MASTERSTOP and FLOWSTOP swelling tapes

MasterMastic PU swelling paste



Single-component, swellable polyurethane paste for sealing construction joints and penetrations in water-impermeable concrete structures or for fixing swelling tapes:



Art. no. 010030
310 ml cartridge

- For dry and damp substrates
- Solvent-free
- Application: +5°C to +45°C
- Physiologically harmless
- Setting speed:
approx. 6 – 7 mm/24 hrs.

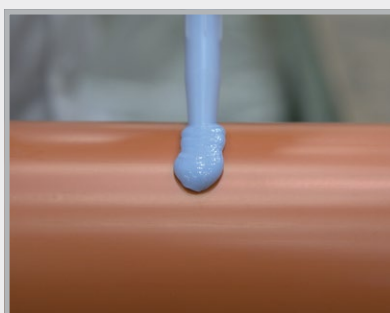

Openings

**Certified waterproofing up to 40 m water column
(test report MFPA Leipzig)**

- Application: Circular Ø approx. 8-10 mm
- Usage: approx. 80-100 ml/m
- Adheres to: Concrete, steel, stone, hard PVC
Not suitable for polypropylene!
- Installation: Inside the reinforcement with at least 8 cm concrete cover
Protect against premature swelling from moisture and rain.

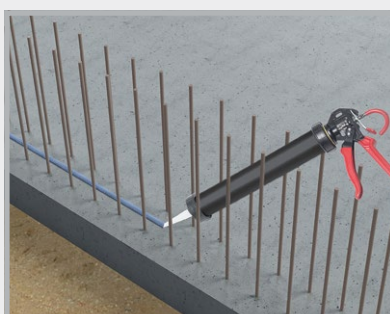

Construction joints

General Building Supervisory Test Certificate according to WU guideline up to 20 m water column

- Application: Bead approx. 35 x 12 mm
- Usage: approx. 300-350 ml/m*
- Adheres to: Dust-free, dry or matt damp concrete surfaces
- Installation: Inside the reinforcement with at least 8 cm concrete cover
Protect against premature swelling from moisture and rain.



Fixing of swelling tape

- Application: Bead Ø approx. 6-8 mm
- Usage: approx. 45 – 50 ml/m*
- Adheres to: Dust-free, dry or matt damp concrete surfaces

* Depending on the concrete roughness

JOINT SHEET METALS



Coated joint sheet metals
pages 26 – 29



Crack-inducing profiles
pages 30 – 31

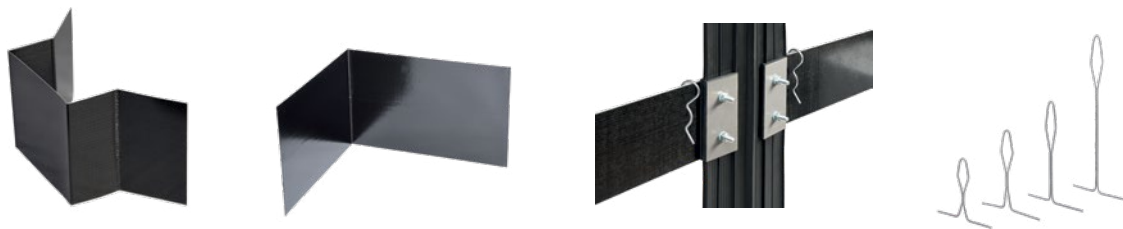

Accessories for coated joint sheet metals
pages 31 – 32



Uncoated joint sheet metal & accessories/joint tape & accessories
pages 33 – 35



Rib laths, formwork systems & accessories
pages 36 – 63

Coated joint sheet metals

High-pressure VB joint sheet metals

Joint sheet metals with reactive, bitumen-free polymer coating for sealing construction joints.

- Very high-pressure water tests
- Resistance tests
- All-weather installation: -20°C to +70°C

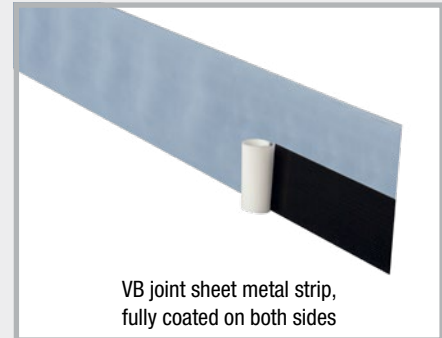
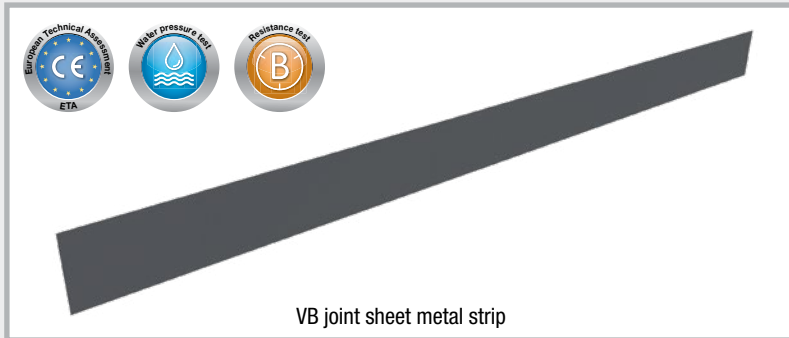

VB joint sheet metal strips

Technical details pages 64 – 65

Art.Gr. 200

Art. no.	Description	PU	Weight
NEW! 070430	VB joint sheet metal in crate Length 2.4 m, height 160 mm, 1 crate = 120 m (50 strips of 2.4 m each), fully coated on both sides, incl. 55 fixing clips	1 crate = 120 m 1 pallet = 12 crates Suitable omega bracket Art. no. 070415, page 32	115.50 kg per crate
NEW! 070432	VB joint sheet metal in crate Length 2.0 m, height 160 mm, 1 crate = 100 m (50 strips of 2 m each), fully coated on both sides, incl. 55 fixing clips	1 crate = 100 m 1 pallet = 12 crates Suitable omega bracket Art. no. 070415, page 32	98.50 kg per crate

Joint sheet metal 80 for the wall/slab connection

Art.Gr. 202

Art. no.	Description	PU	Weight
070455	Joint sheet metal 80 in crate Length 2.4 m, height 80 mm, 1 crate = 120 m (50 strips of 2.4 m each), fully coated on both sides, incl. 55 fixing clips	1 crate = 120 m 1 pallet = 12 crates Suitable omega bracket Art. no. 070413, page 32	65.00 kg per crate

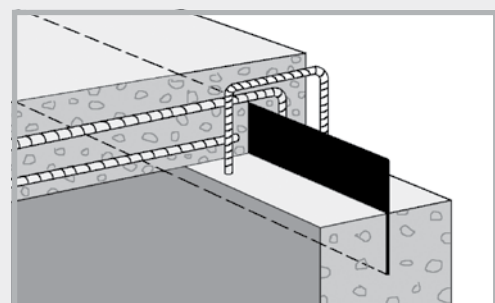

VB joint sheet metal rolls Technical details pages 64 – 65

Art. no.	Description	Design	PU	Weight
070468	Joint sheet metal roll - F with fixing angle Height 160 mm, Roll length 20 m incl. 2 fixing clips	fully coated on both sides (VB2)	1 roll = 20 m per carton	17.85 kg per carton
NEW! 070469		fully coated on one side (VB1)	1 pallet = 36 cartons	17.05 kg per carton
070461	Joint sheet metal roll 160 VB Height 160 mm, Roll length 20 m incl. 30 omega brackets and 2 fixing clips	fully coated on both sides (VB2)	1 roll = 20 m per carton	18.50 kg per carton
070460		fully coated on one side (VB1)	1 pallet = 36 cartons	17.80 kg per carton
070464	Joint sheet metal roll 120 VB Height 120 mm, Roll length 20 m incl. 30 omega brackets and 2 fixing clips	fully coated on both sides (VB2)	1 roll = 20 m per carton	13.50 kg per carton
070463		fully coated on one side (VB1)	1 pallet = 48 cartons	13.05 kg per carton
070462	Joint sheet metal roll 240 VB Height 240 mm, Roll length 20 m incl. 30 omega brackets and 4 fixing clips	fully coated on both sides (VB2)	1 roll = 20 m per carton 1 pallet = 24 cartons	26.75 kg per carton

Wherever required, we supply the rolls incl. the required omega brackets as standard. You will find prices for the version without omega brackets in our Excel price list.

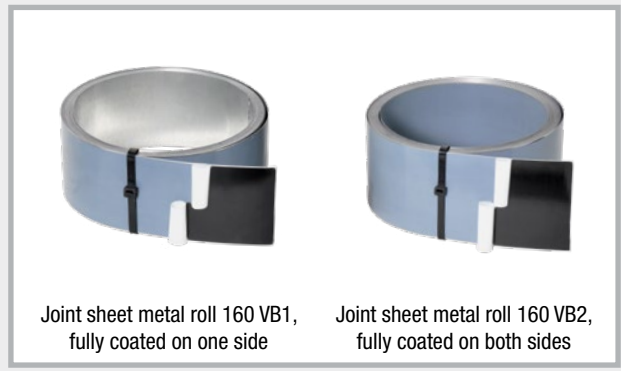
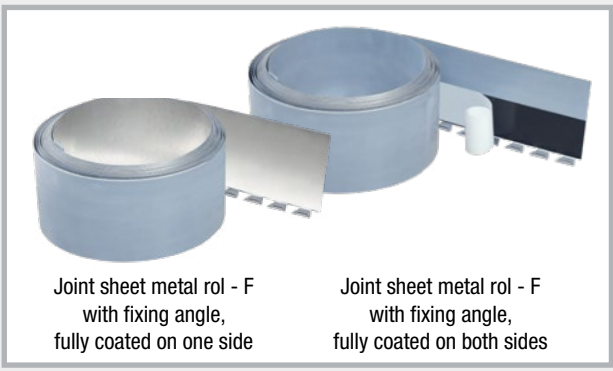

MASTER joint sheet metal

The joint sheet metal with support rail



Art.Gr. 203

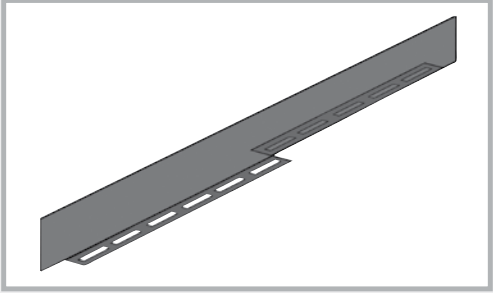

Art. no.	Description	PU	Weight
070200	MASTER joint sheet metal Length 2.5 m, height 160 mm, 1 crate = 100 m (40 strips of 2.5 m each), Sealing element fully coated on both sides, with support rail, 20 mm perforated, incl. 45 fixing clips Technical details page 66	1 crate = 100 m 1 pallet = 12 crates	142.50 kg per crate

MB joint sheet metal

Mineral-coated joint sheet metal for waterproofing of construction joints



Art.Gr. 204

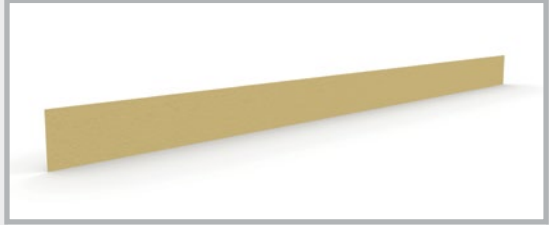

Art. no.	Description	PU	Weight
NEW! 070481	Joint sheet metal MB 160, overlap type Length 2.4 m, height 160 mm, 1 crate = 120 m (50 strips of 2.4 m each), with full mineral coating on both sides, incl. 55 fixing clips Technical details page 67	1 crate = 120 m 1 pallet = 12 crates Suitable omega bracket Art. no. 070415, page 32	130.50 kg per crate

AKTIV joint sheet metal

The active, bentonite-coated joint sheet metal



Art.Gr. 205



Art. no.	Description	PU	Weight
070490	AKTIV joint sheet metal Roll length 10 m, height 160 mm, fully coated on one side with bentonite, incl. 20 omega brackets, 4 fixing clips and 1.5 m adhesive tape for bonding of joints Technical details page 68	1 roll = 10 m per carton 1 pallet = 36 cartons incl. fastening material	14.70 kg per carton

MASTER-MultiFlex (MMF 140)



active joint tape for waterproofing of construction joints in concrete
with General Building Supervisory Test Certificate (abP)

Technical details pages 69 – 70

Art.Gr.
212

Art. no.	Description	PU	Weight	
NEW! 080646	MMF 140 MASTER-MultiFlex Construction joint tape with additional swelling profile Height 140 mm, Roll length 25 m	1 roll = 25 m per carton 1 pallet = 32 cartons	26.80 kg per carton	
080647	MMF 140 Omega bracket additional omega brackets to secure the MMF 140 in position on the reinforcement, Requires approx. 2 pcs. per metre	1 sack of 50 pcs.	3.90 kg per sack	
070605	MMF 140 MASTER-Connect "active" Joint tape connector with additional swelling tape	1 pc.	1.80 kg per pc.	

VB joint sheet metal JGS (slurry/liquid manure/silage effluent)



The joint sheet metal for storage and filling facilities of slurry/liquid manure/silage effluent and biogas facilities with national technical approval (abZ)

National technical approval (abZ): Z-74.101-209

Technical details page 71

Art.Gr.
220



Art. no.	Description	PU	Weight	
070476	VB joint sheet metal JGS, roll Length 20 m, height 160 mm, Joint sheet metal fully coated on both sides, incl. 2 fixing clips	1 roll = 20 m per carton 1 pallet = 36 cartons Suitable omega bracket Art. no. 070415, page 32	18.50 kg per carton	
070477	VB joint sheet metal JGS, roll - F Length 20 m, height 160 mm, Joint sheet metal fully coated on both sides, with fixing angle, incl. 2 fixing clips	1 roll = 20 m per carton 1 pallet = 36 cartons	17.85 kg per carton	
070475	VB joint sheet metal JGS, strips Length 2.4 m, height 160 mm, 1 crate = 120 m (50 strips of 2.4 m each), Joint sheet metal fully coated on both sides, incl. 55 fixing clips	1 crate = 120 m 1 pallet = 12 crates Suitable omega bracket Art. no. 070415, page 32	115.50 kg per crate	

All versions of the stopend panels ABS (page 40/41) are also available in JGS (slurry/liquid manure/silage effluent) design.

Crack-inducing profiles

Technical details pages 72 – 73

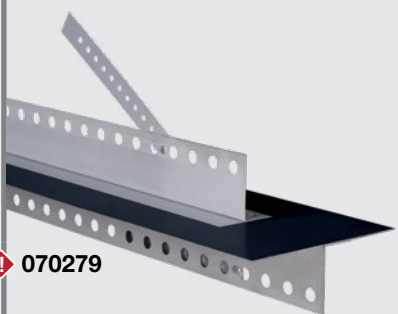
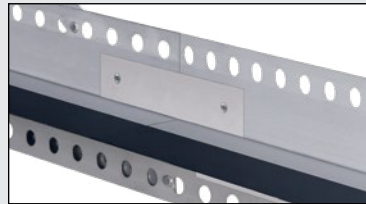
Art.Gr. 215

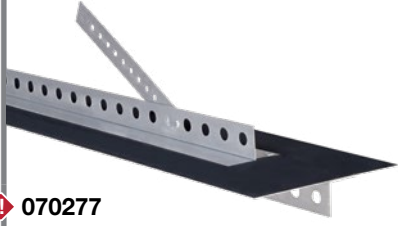
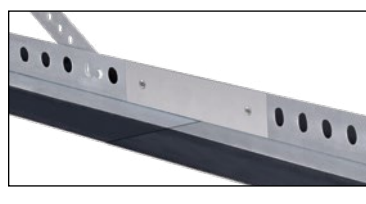
Art. no.	Description	PU	Weight
070280   NEW! 070279	SRF 125 Multi In-situ concrete wall type, Coated crack-inducing profile, Length: 2.5 m incl. 2 fixing clips with perforated support rail and perforated foldable retaining plates Type for in-situ concrete walls, Wall thicknesses up to 36.5 cm	1 pc. 1 pallet = 120 pcs.	4.85 kg per pc.
070280K 	SRF 125 Multi short piece In-situ concrete wall type, extension set Length: 0.6 m incl. suitable connection set, Consists of: 2 pcs. connecting plates, 4 pcs. self-tapping screws		1.10 kg per pc.
070278   NEW! 070277	SRF 125 Multi Cavity wall type, Coated crack-inducing profile, Length: 2.5 m incl. 2 fixing clips with perforated support rail and perforated foldable retaining plates Type for cavity walls, Wall thicknesses up to 40 cm	1 pc. 1 pallet = 120 pcs.	4.00 kg per pc.
070278K 	SRF 125 Multi short piece Cavity wall type, Extension set, Length: 0.6 m incl. suitable connection set, Consists of: 2 pcs. connecting plates, 4 pcs. self-tapping screws		0.93 kg per pc.

FOR IN-SITU CONCRETE WALLS



FOR CAVITY WALLS

Up to a wall thickness of 300 mm also suitable for use in corner butt joint; VB joint sheet metal corner element FB (art. no. 070224) required (see technical details, page 73)

Crack-inducing profiles

Technical details pages 74 – 75



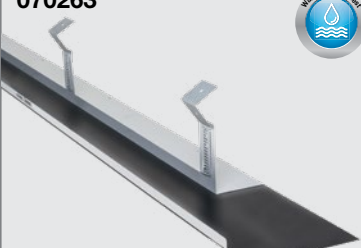

Art.Gr.
206

Art. no.	Description	PU	Weight
070250	 <p>MASTER joint sheet metal SFG Length: 2.5 m incl. 5 nail plugs 5/50 and 4 fixing clips, adjustable bracket Extension at the construction site possible Wall thicknesses up to 40 cm</p>	1 pc. 1 pallet = 88 pcs.	4.70 kg per pc.
070260	 <p>MASTER joint sheet metal SFE Length: 2.5 m incl. 5 nail plugs 5/50 and 4 fixing clips, adjustable bracket Extension at the construction site possible Wall thicknesses up to 40 cm</p>	1 pc. 1 pallet = 80 pcs.	5.15 kg per pc.
070263	 <p>MASTER joint sheet metal FE Length: 2.5 m incl. 5 nail plugs 5/50 and 4 fixing clips, adjustable bracket Extension at the construction site possible Wall thicknesses up to 40 cm MASTER joint sheet metal corner element FB (art. no. 070273) required</p>	1 pc. 1 pallet = 72 pcs.	4.95 kg per pc.



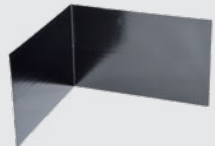



FOR CAVITY WALLS

Accessories for coated joint sheet metals

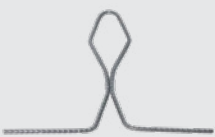
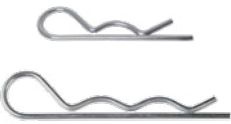
Art.Gr.
221

Art. no.	Description	PU	Weight
070275	 <p>Joint sheet metal VB angle 90° side length 25 x 25 cm, Height 160 mm</p>	1 pc.	0.42 kg per pc.
070270	 <p>MASTER joint sheet metal angle 90° side length 25 x 25 cm, with fixing rail</p>	1 pc.	0.62 kg per pc.
070224	 <p>VB joint sheet metal corner element FB suitable for SRF 125 Multi corner butt joint (art. no. 070277 + 070278)</p>	1 pc.	0.46 kg per pc.
070273	 <p>MASTER joint sheet metal corner element FB with fixing rail suitable for MASTER joint sheet metal FE crack-inducing profile (Art. no. 070263)</p>	1 pc.	0.58 kg per pc.

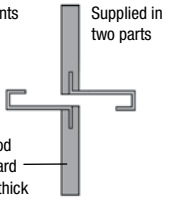
Accessories for coated joint sheet metals

Art. no.	Description	PU	Weight
NEW! 070413 070415 070421 070422		Omega bracket Art.Gr. 222 for joint sheet metals up to height 125 mm	per sack 5.85 kg
		up to height 160 mm	150 pcs./sack
		Height 161-205 mm	150 pcs./sack
		Height 206-330 mm	150 pcs./sack
NEW! 070412 070410		Fixing clip for securing the overlapping joints suitable for height 80 + 120 mm	1 bag of 55 pcs. 1.90 kg per bag
		suitable for height 160 + 240 mm	1 bag of 55 pcs. 3.10 kg per bag
070230 		Joint sheet metal/ joint tape connector Art.Gr. 230 transition from joint sheet metal to joint tape Technical details page 87	1 set = 2 pcs. 2.50 kg per set
070240 	MASTER adhesive tape for joint sheet metal Art.Gr. 230 Adhesive tape for securing joints and crossing points, thickness 1.5 mm, roll length 10 m, width 38 mm	1 carton of 16 rolls	0.95 kg per roll
070266 070267 070268		Soundproofing joint Art.Gr. 208 Element length 2.5 m	1 set = 2.5 m 2.55 kg/m 1 set = 2.5 m 2.85 kg/m 1 set = 2.5 m 3.30 kg/m
		DSK 24/25 for wall thickness 24 + 25 cm	
		DSK 30 for wall thickness 30 cm	
		DSK 35/36.5 for wall thickness 35 + 36.5 cm	
<div style="border: 1px solid black; padding: 5px; width: fit-content;"> 2 elements = 1 set Supplied in two parts  </div> <p>Soft wood fibre board 30 mm thick</p>		1 soundproofing joint set consists of 2 elements. Technical details page 86	
070269 	Sound joint tape DSF Art.Gr. 208 Internal A24 construction joint tape according to DIN 18541, specially coated up to 15 cm on one side, compatible with bitumen, roll length 3 m Technical details page 86	1 roll	4.35 kg per roll

1 SWELLING TAPES
 2 JOINT SHEET METALS
 3 INJECTION HOSES
 CONSTRUCTION CHEMISTRY
 4 SERVICE DUCTS
 5 LIGHTNING PROTECTION
 6 FORMWORK ACCESSORIES

Uncoated joint sheet metals

in accordance with the WU directive

The DAfStb guideline "Water-Impermeable Concrete Structures" (WU guideline) requires a sheet thickness of at least 1.5 mm for uncoated joint sheet metals as construction joint waterproofing in water-impermeable structures. The following sheet height requirements apply for stress class 1 and service class A:

≥ 250 mm: up to 3 m water pressure height

≥ 300 mm: 3 m to 10 m water pressure height

The sheets must be embedded with half their height on both sides of the joint.

Small coils

Uncoated joint sheet metal, black, as roll material with 30 m length



Art. no.	Description	PU	Secondary packaging	Weight per roll
070175	Joint sheet metal, black, 1.5 x 250 mm in accordance with the WU directive	1 roll of 30 m	1 pallet = 12 rolls	90.00 kg
070176	Joint sheet metal, black, 1.5 x 300 mm in accordance with the WU directive	1 roll of 30 m	1 pallet = 10 rolls	108.00 kg
070177	Joint sheet metal, black, 2.0 x 200 mm	1 roll of 30 m	1 pallet = 12 rolls	96.00 kg
070178	Joint sheet metal, black, 2.0 x 250 mm in accordance with the WU directive	1 roll of 30 m	1 pallet = 10 rolls	120.00 kg
070180	Joint sheet metal, black, 2.0 x 300 mm in accordance with the WU directive	1 roll of 30 m	1 pallet = 8 rolls	144.00 kg
070090	Joint sheet metal, galvanised, 0.6 x 100 mm	1 roll of 30 m	1 pallet = 60 rolls	14.40 kg
070100	Joint sheet metal, galvanised, 0.6 x 125 mm	1 roll of 30 m	1 pallet = 60 rolls	18.00 kg
070110	Joint sheet metal, galvanised, 0.6 x 150 mm	1 roll of 30 m	1 pallet = 48 rolls	21.60 kg
070120	Joint sheet metal, galvanised, 0.6 x 200 mm	1 roll of 30 m	1 pallet = 36 rolls	28.80 kg
070181	Joint sheet metal, galvanised, 2.0 x 300 mm	1 roll of 30 m	1 pallet = 8 rolls	153.85 kg

Black joint sheet metals with a min. thickness of 1.5 mm and a min. height of 250 mm comply with the German WU directive for Water-Impermeable Concrete Buildings. Sheets with smaller dimensions and galvanised sheets do not comply with the directive for water-tight structures.

Joint sheet metal, strip material

Uncoated joint sheet metal, black, as strip material with 2.5 m length in accordance with the German WU directive for Water-Impermeable Concrete Buildings

Art.Gr.
231

Art. no.	Description	PU	Weight per strip
131105	Joint sheet metal strips black, 1.5 x 250 mm, length 2.5 m	1 strip of 2.5 m	7.50 kg
131205	Joint sheet metal strips black, 1.5 x 300 mm, length 2.5 m	1 strip of 2.5 m	9.00 kg
131305	Joint sheet metal strips black, 2.0 x 250 mm, length 2.5 m	1 strip of 2.5 m	9.50 kg
131405	Joint sheet metal strips black, 2.0 x 300 mm, length 2.5 m	1 strip of 2.5 m	11.50 kg

Suitable installation and joining accessories for the roll and strip products can be found on page 35.

Joint tape, factory standard PVC

Construction joint tape, internal

Art.Gr. 211

Type	Tape width	Roll length	PU	Weight per roll	PVC Factory standard
A 19	190 mm	25 m	1 pc.	22.50 kg	080500
A 24	240 mm	25 m	1 pc.	30.00 kg	080510
A 32	320 mm	25 m	1 pc.	45.00 kg	080520

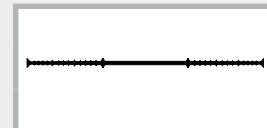

Construction joint tape, external

Art.Gr. 211

AA 19	190 mm	25 m	1 pc.	29.00 kg	080530
AA 24	240 mm	25 m	1 pc.	40.00 kg	080540
AA 32	320 mm	25 m	1 pc.	57.50 kg	080550

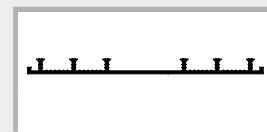

Expansion joint tape, internal

Art.Gr. 211

D 19	190 mm	25 m	1 pc.	28.75 kg	080650
D 24	240 mm	25 m	1 pc.	37.50 kg	080660
D 32	320 mm	25 m	1 pc.	57.50 kg	080670

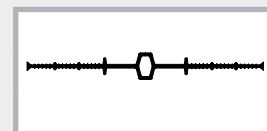

Expansion joint tape, external

Art.Gr. 211

DA 19	190 mm	25 m	1 pc.	36.25 kg	080680
DA 24	240 mm	25 m	1 pc.	45.00 kg	080690
DA 32	320 mm	25 m	1 pc.	62.50 kg	080700



Crack inducer tubes

Art.Gr. 211

Art. no.	Type	Diameter/mm	Pipe length	PU	Pipe weight
080712	Q 1	88 WS 24 – 35	3.0 m	1 pc.	8.00 kg

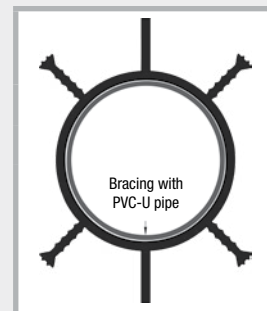

Joint tape clamp

Art.Gr. 230

Art. no.	Description	PU	Weight
070510	Joint tape clamp 3 pcs. per metre and side	1 carton of 200 pcs.	1.50 kg per carton



MASTER-Connect

Connector for joint sheet metals and joint tapes

MASTER-Connect joint sheet metal



Technical details page 88

Art.Gr. 210

Art. no.	Description	PU	Weight/pc.	
070196	MASTER-Connect joint sheet metal F150 for joint sheet metal heights up to 150 mm	1 pc.	1.70 kg per pc.	
070193	MASTER-Connect joint sheet metal F250 for joint sheet metal heights up to 250 mm	1 pc.	2.90 kg per pc.	
070194	MASTER-Connect joint sheet metal F330 for joint sheet metal heights up to 330 mm	1 pc.	3.75 kg per pc.	

- Resistance:**
- Oil and petrol
 - Diluted acids and alkalis
 - Liquid manure and slurry
 - Fermentation mash
 - Radon and methane gas

MASTER-Connect joint tape



Technical details page 88

Art.Gr. 210

Art. no.	Description	PU	Weight/pc.	
070610	MASTER-Connect joint tape B250 for joint tape widths up to 250 mm	1 pc.	2.75 kg per pc.	
070620	MASTER-Connect joint tape B330 for joint tape widths up to 330 mm	1 pc.	3.75 kg per pc.	

- Resistance:**
- Diluted acids and alkalis
 - Liquid manure and slurry
 - Fermentation mash

Upstand elements

Installation aid for joint sheet metals and joint tapes

Art.Gr. 224

Art. no.	Description	PU	Weight/pc.
070650	Upstand element for joint sheet metal, rough Height 150 mm, width 150 mm, length 2400 mm, for joint sheet metals 250 and 300 mm	1 pc.	6.55 kg
070652	Upstand element for joint tape, rough Height 150 mm, width 150 mm, length 2400 mm, for internal joint tape A24 and A32	1 pc.	8.00 kg

Version with base or as toothed joint available on request

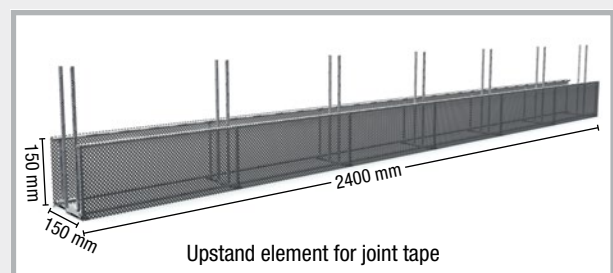
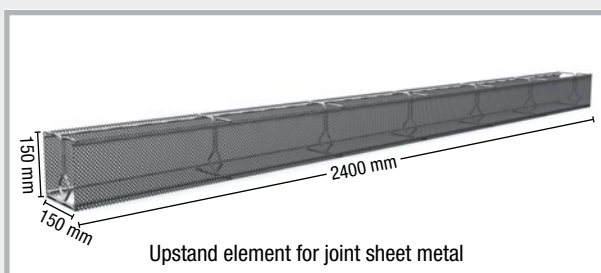

Rib laths

Lost formwork for construction joints in concrete

Rib lath formwork, flat-ribbed

Lost formwork/plaster base

- Effective bond between concrete segments
- Highly malleable

Material: Galvanised

Rib height: 4 mm

Thickness: 0.25 mm

Sheet size: Length 250 cm, width 60 cm

Art.Gr.
226

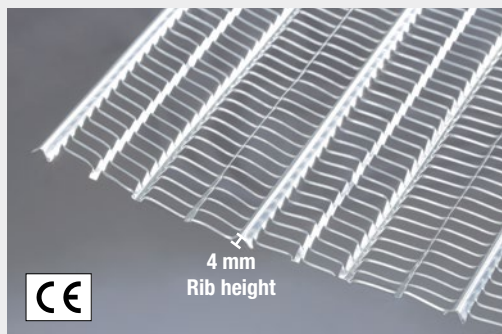

Art. no.	Description	PU	Secondary packaging	Weight
020045	Thickness 0.25 mm , galvanised Size: 250 x 60 cm = 1.5 m ² , Rib height approx. 4 mm, Identification colour: yellow	1 package of 20 sheets = 30 m ²	1 pallet of 30 packages = 900 m ²	approx. 22 kg per package 0.73 kg/m ²

Rib lath formwork, medium-ribbed

Lost formwork

- Effective bond between concrete segments
- Good malleability

Material: Galvanised

Rib height: 10 mm

Sheet size: Length 250 cm, width 60 cm

Art.Gr.
227

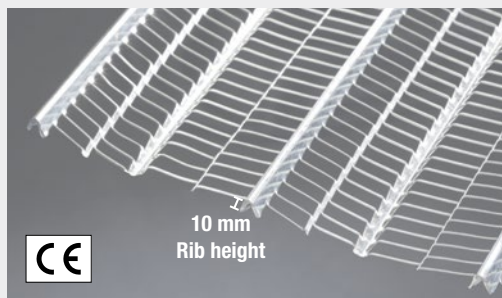

Art. no.	Description	PU	Secondary packaging	Weight
020040	Thickness 0.30 mm , galvanised, Size: 250 x 60 cm = 1.5 m ² , Rib height approx. 10 mm, Identification colour: black	1 package of 20 sheets = 30 m ²	1 pallet of 25 packages = 750 m ²	approx. 36 kg per package 1.20 kg/m ²

Rib lath formwork, high-ribbed

Lost formwork

- Developed for concrete construction
- Extremely stable
- Perfect bond between concrete segments
- Very good malleability

Material: Galvanised

Rib height: 21 mm

Art.Gr.
228

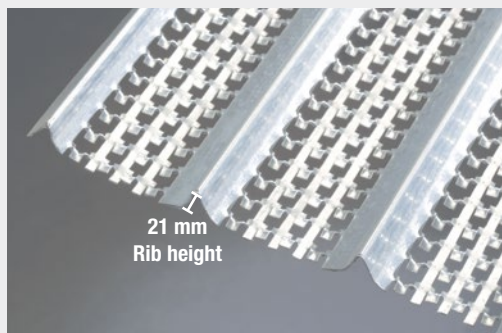

Art. no.	Description	PU	Secondary packaging	Weight
020005	Thickness 0.3 mm , galvanised, Size: 200 x 45 cm, rib height 21 mm, Identification colour: green	1 pallet of 200 pcs. = 180 m ²	3 pallets	436 kg per pallet approx. 2.42 kg per m ²
020010	Thickness 0.4 mm , galvanised, Size: 200 x 45 cm, rib height 21 mm, Identification colour: blue	1 pallet of 100 pcs. = 90 m ²	5 pallets	301 kg per pallet approx. 3.34 kg per m ²
020020	Thickness 0.5 mm , galvanised, Size: 200 x 45 cm, rib height 21 mm, Identification colour: red	1 pallet of 100 pcs. = 90 m ²	4 pallets	366 kg per pallet approx. 4.06 kg per m ²

LinkFix stopend panel

Art.Gr.
229

Profiled rib lath formwork as stopend panel for construction joints

Material: Profiled rib lath formwork of bright steel, thickness 0.75 mm

Joint category: toothed according to DIN EN 1992-1-1 NA (EC2)

Profile: 57 x 41 x 20 mm

Sheet size: Length 240 cm,
width 80 cm

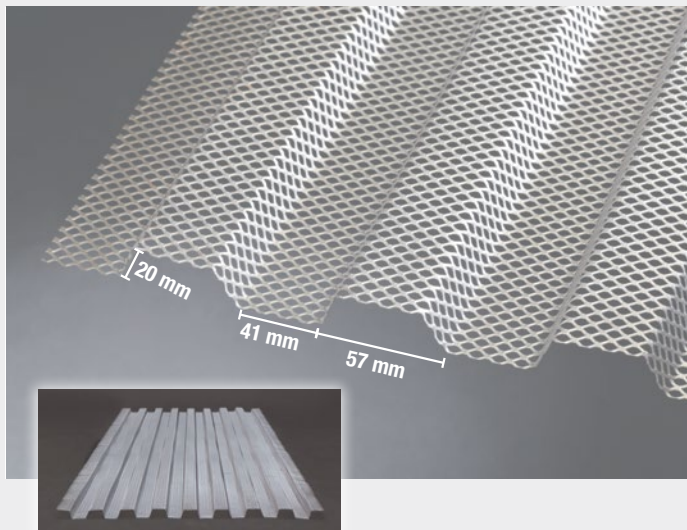

Art. no.	Description	PU	Weight
020050	LinkFix thickness 0.75 mm, Size: 240 x 80 cm	1 pallet of 100 pcs. = 192 m ²	536 kg per pallet approx. 2.79 kg per m ²

LinkForm stopend panel

Art.Gr.
229

Rib lath formwork as stopend panel for construction joints

Material: Rib lath formwork of bright steel, thickness 0.75 mm.

Joint category: rough according to DIN EN 1992-1-1 NA (EC2)

Sheet size: Length: 240 cm,
Width 100 cm

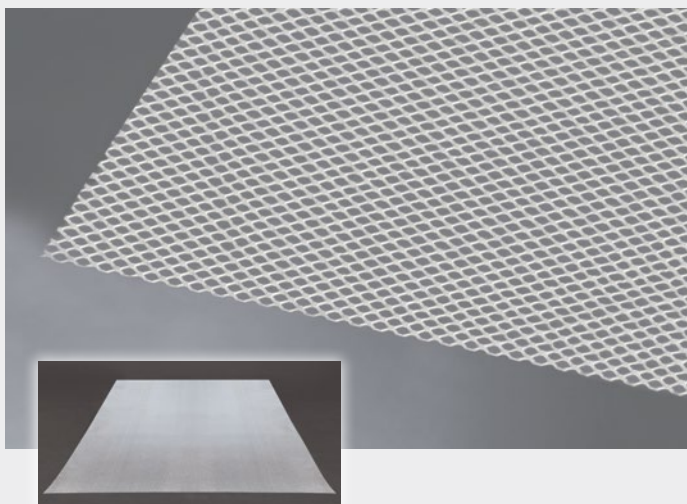

Art. no.	Description	PU	Weight
070520	LinkForm Thickness 0.75 mm, Size 240 x 100 cm	1 pallet of 100 pcs. = 240 m ²	536 kg per pallet approx. 2.23 kg per m ²

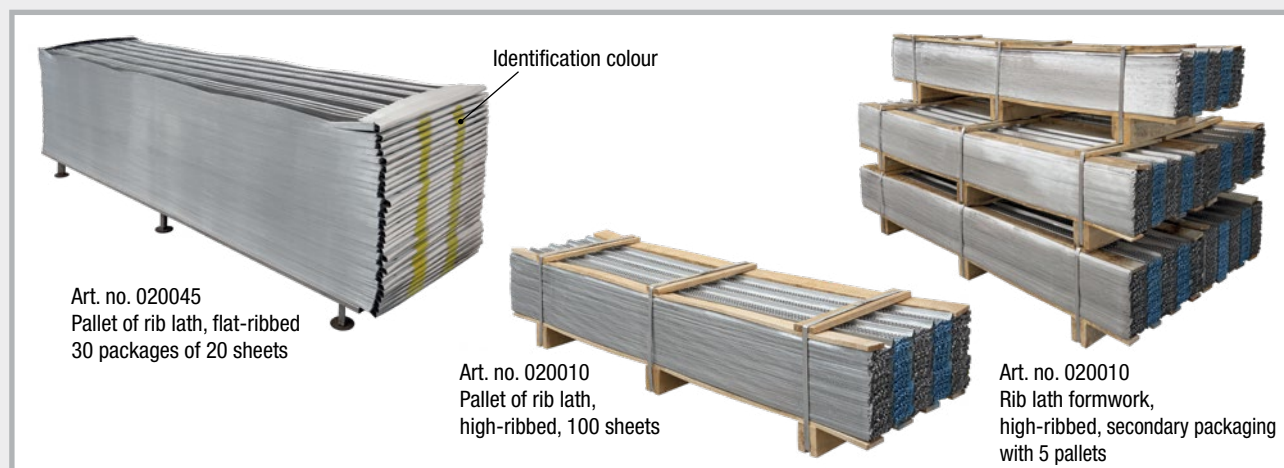

Formwork systems

Stopend panels ABS/special profiles/accessories pages 40 – 49

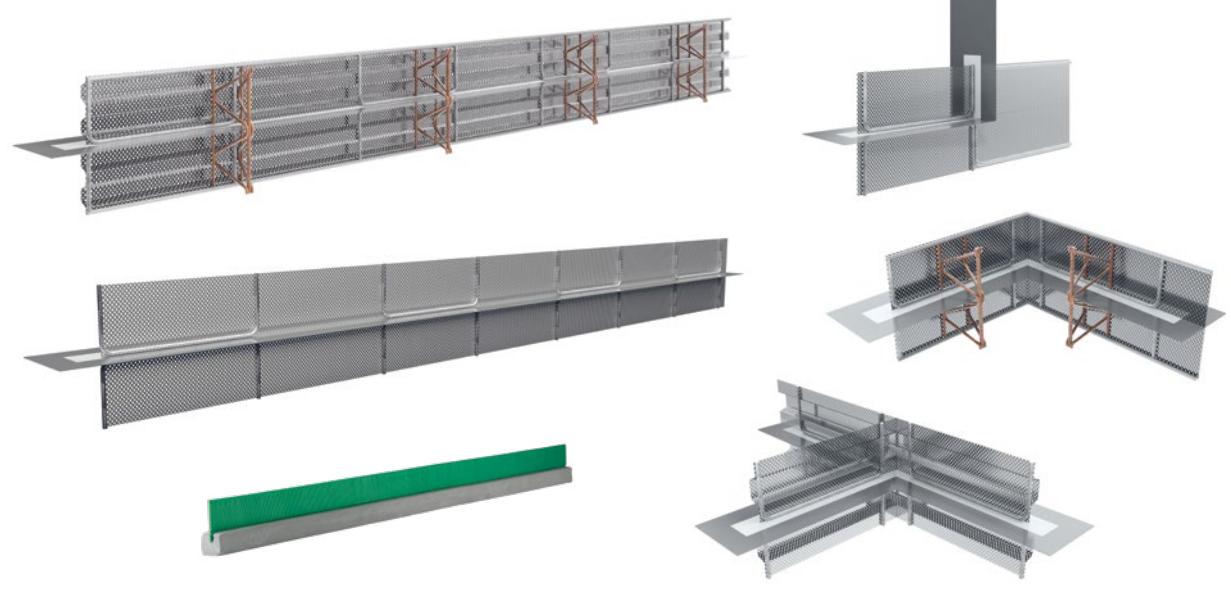

ABS crack-inducing elements pages 50 – 51

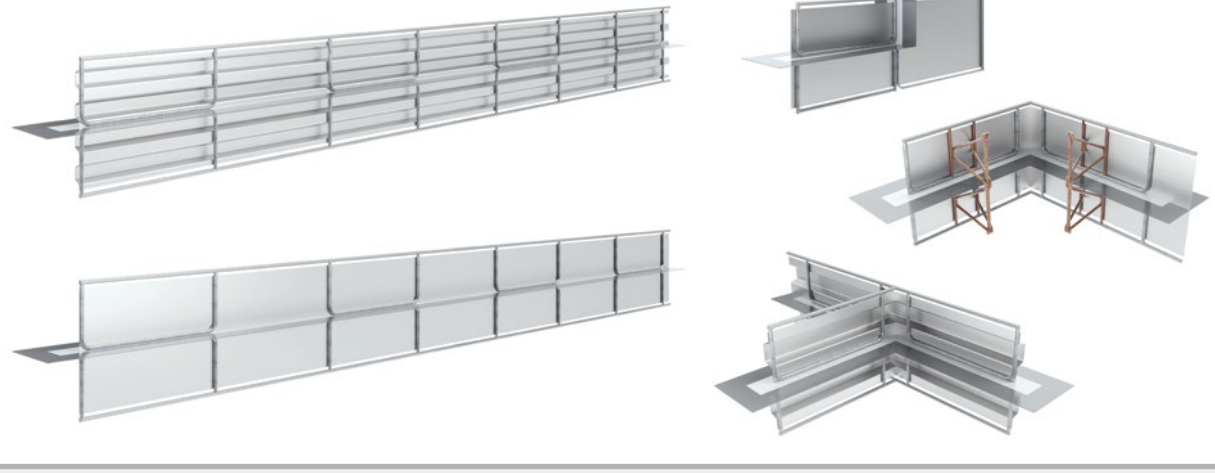

Stopend panels with integrated uncoated joint sheet metal pages 52 – 53

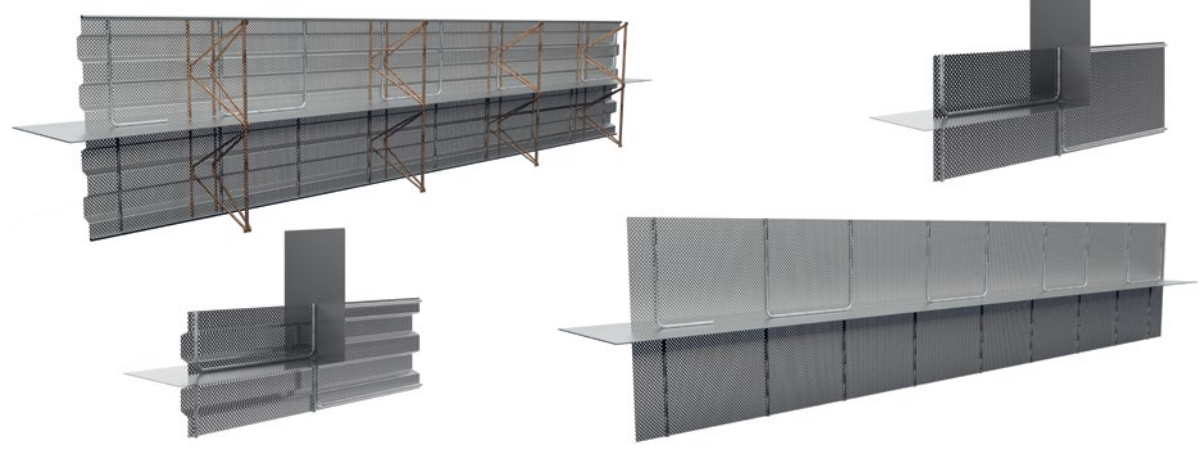

Stopend panels and crack-inducing elements LinkFix/LinkForm

pages 54 – 55

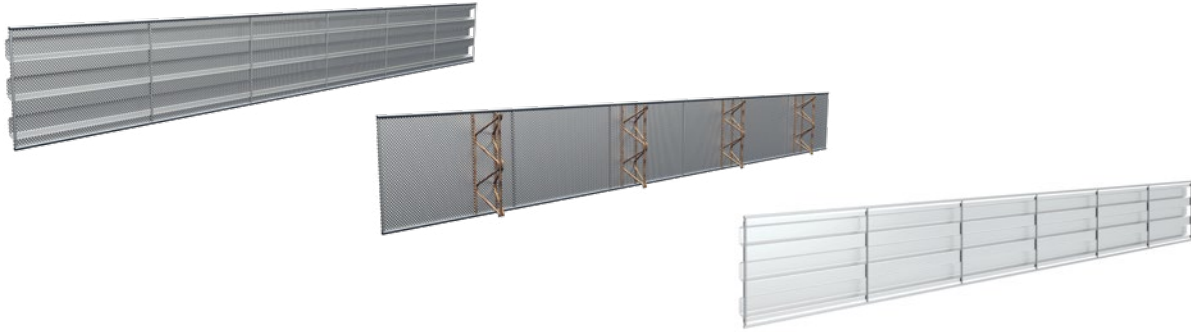

ABS joint sheet metal cage

pages 56 – 57

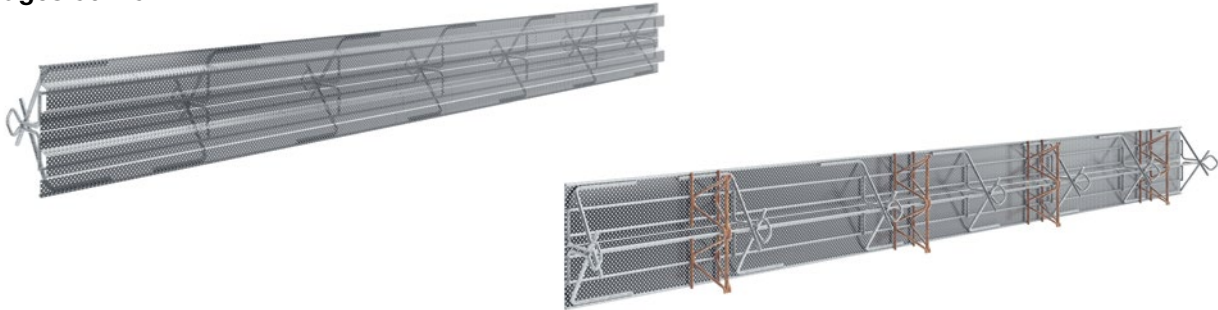

ABS joint tape cage

pages 58 – 61



ABS expansion joint elements

pages 62 – 63



Stopend panels ABS



Stopend panels ABS toothed

with joint sheet metal coated on both sides Technical details pages 76 – 78

Art.Gr. **207**

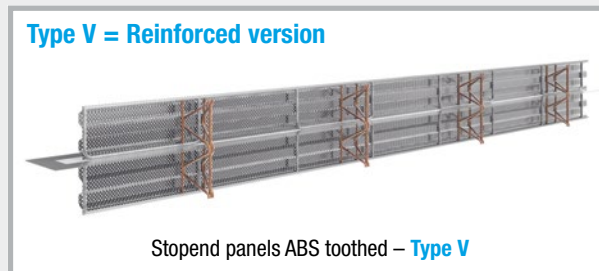
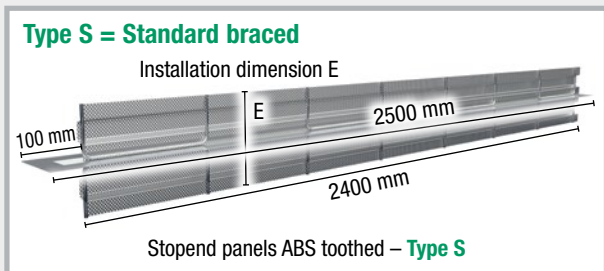

Description	Installation dimension E = Rib lath width	Length	Type S = Standard braced		V = Reinforced version	
			Art. no.	Weight/pc.	Art. no.	Weight/pc.
ABS 160 toothed	Up to 160 mm	2.5 m	070362	5.60 kg	070362V	8.55 kg
ABS 200 toothed	170 – 200 mm	2.5 m	070364	6.00 kg	070364V	9.20 kg
ABS 250 toothed	210 – 250 mm	2.5 m	070366	6.45 kg	070366V	10.00 kg
ABS 300 toothed	260 – 300 mm	2.5 m	070368	7.00 kg	070368V	10.90 kg
ABS 400 toothed	310 – 400 mm	2.5 m	070370	8.00 kg	070370V	12.65 kg
ABS 500 toothed	410 – 500 mm	2.5 m	070372	9.70 kg	070372V	15.00 kg
ABS 600 toothed	510 – 600 mm	2.5 m	070374	10.30 kg	070374V	16.35 kg
ABS 700 toothed	610 – 700 mm	2.5 m	070376	10.95 kg	070376V	17.65 kg
ABS 800 toothed	710 – 800 mm	2.5 m	070378	12.65 kg	070378V	20.05 kg
ABS 900 toothed	810 – 900 mm	2.5 m	070380	13.25 kg	070380V	21.35 kg
ABS 1000 toothed	910 – 1000 mm	2.5 m	070382	13.90 kg	070382V	22.70 kg

All intermediate dimensions of the rib lath width available.
Installation dimension E > 1000 mm available on request
For proper formwork results, we recommend our ABS formwork comb type spacers.



All sizes also available in JGS (slurry/liquid manure/silage effluent) version

Installation situation

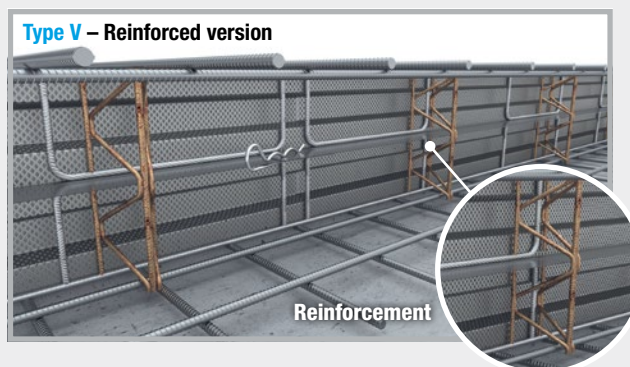
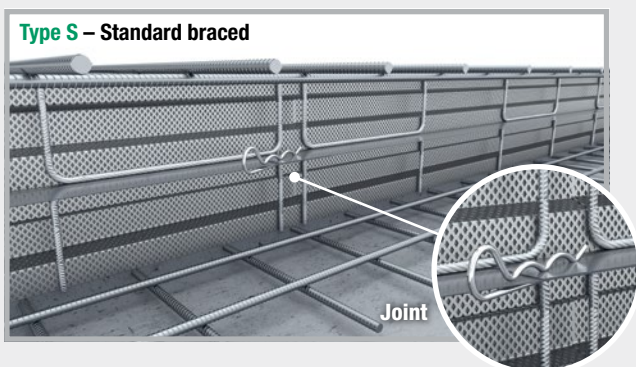

Stopend panels ABS rough

with joint sheet metal coated on both sides Technical details pages 76 – 78

Art.Gr.
207

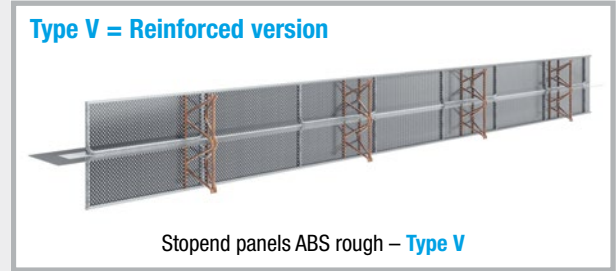
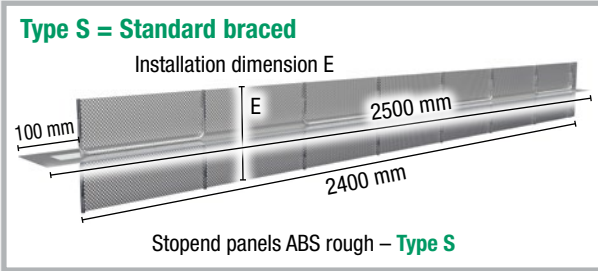

Description	Installation dimension E = Rib lath width	Length	Type S = Standard braced		Type V = Reinforced version	
			Art. no.	Weight/pc.	Art. no.	Weight/pc.
ABS 130 rough	Up to 130 mm	2.5 m	070281	5.15 kg	070281V	7.80 kg
ABS 160 rough	140 – 160 mm	2.5 m	070282	5.40 kg	070282V	8.30 kg
ABS 200 rough	170 – 200 mm	2.5 m	070284	5.75 kg	070284V	8.95 kg
ABS 250 rough	210 – 250 mm	2.5 m	070287	6.15 kg	070287V	9.70 kg
ABS 300 rough	260 – 300 mm	2.5 m	070289	6.60 kg	070289V	10.50 kg
ABS 400 rough	310 – 400 mm	2.5 m	070291	7.50 kg	070291V	12.15 kg
ABS 500 rough	410 – 500 mm	2.5 m	070293	9.05 kg	070293V	14.40 kg
ABS 600 rough	510 – 600 mm	2.5 m	070295	9.55 kg	070295V	15.60 kg
ABS 700 rough	610 – 700 mm	2.5 m	070297	10.05 kg	070297V	16.80 kg
ABS 800 rough	710 – 800 mm	2.5 m	070299	11.60 kg	070299V	19.05 kg
ABS 900 rough	810 – 900 mm	2.5 m	070301	12.10 kg	070301V	20.25 kg
ABS 1000 rough	910 – 1000 mm	2.5 m	070303	12.60 kg	070303V	21.45 kg

All intermediate dimensions of the rib lath width available.
 Installation dimension E > 1000 mm available on request
 For proper formwork results, we recommend our ABS formwork comb type spacers.



All sizes also available in JGS (slurry/liquid manure/silage effluent) version

Installation situation

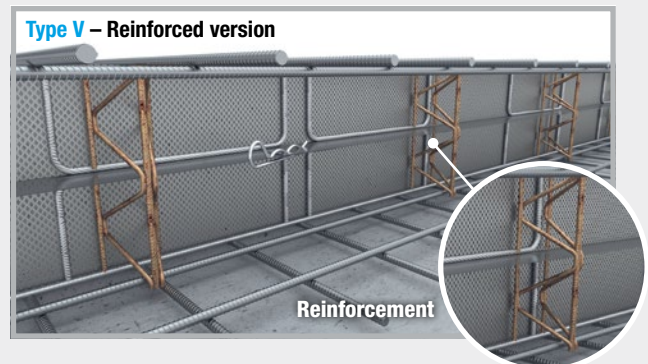
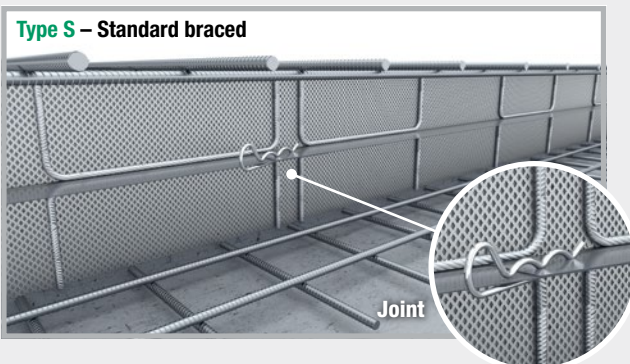

Stopend panel ABS special profiles

ABS deflection profiles (ULP) toothed

with joint sheet metal coated on both sides [Technical details page 79](#)

Art.Gr.
216

Type S = Standard braced

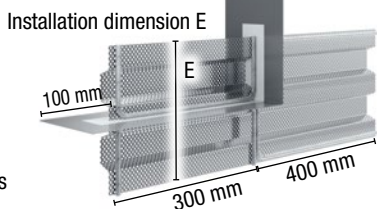

ABS deflection profiles Toothed – **Type S**

Type V = Reinforced version

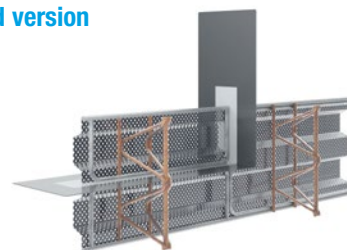

ABS deflection profiles Toothed – **Type V**

Description	Installation dimension E = Rib lath width	Type S = Standard braced		Type V = Reinforced version	
		Art. no.	Weight/pc.	Art. no.	Weight/pc.
ULP 160 toothed	Up to 160 mm	070387	2.05 kg	070387V	2.65 kg
ULP 200 toothed	170 – 200 mm	070389	2.15 kg	070389V	2.85 kg
ULP 250 toothed	210 – 250 mm	070391	2.30 kg	070391V	3.15 kg
ULP 300 toothed	260 – 300 mm	070393	2.80 kg	070393V	3.90 kg
ULP 400 toothed	310 – 400 mm	070395	3.20 kg	070395V	4.60 kg
ULP 500 toothed	410 – 500 mm	070397	3.80 kg	070397V	5.55 kg
ULP 600 toothed	510 – 600 mm	070399	4.05 kg	070399V	6.15 kg
ULP 700 toothed	610 – 700 mm	070401	4.30 kg	070401V	6.75 kg
ULP 800 toothed	710 – 800 mm	070403	4.90 kg	070403V	7.70 kg
ULP 900 toothed	810 – 900 mm	070405	5.15 kg	070405V	8.30 kg
ULP 1000 toothed	910 – 1000 mm	070407	5.40 kg	070407V	8.90 kg

All intermediate dimensions of the rib lath width available.
Installation dimension E > 1000 mm available on request
For proper formwork results, we recommend our ABS formwork comb type spacers.



All sizes also available in JGS (slurry/liquid manure/silage effluent) version

Installation situation

Type S – Standard braced

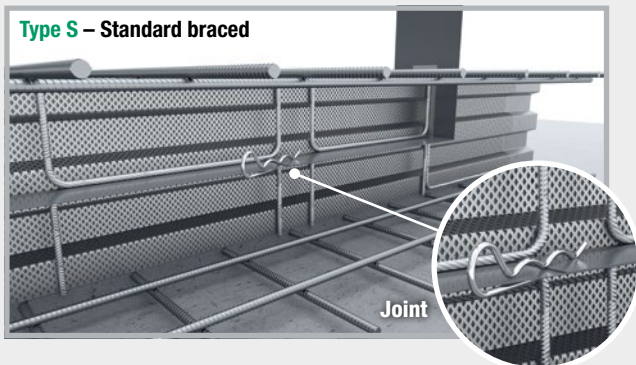

Type V – Reinforced version

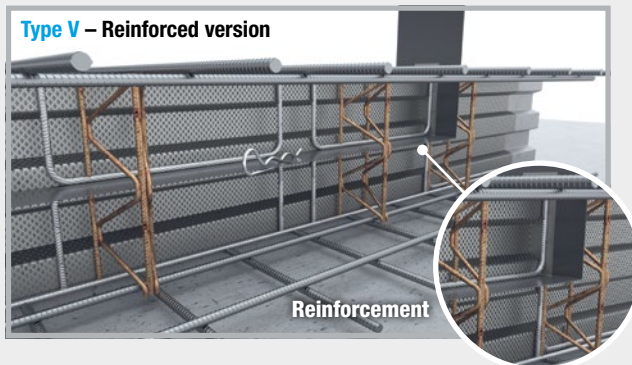

ABS deflection profiles (ULP) rough

with joint sheet metal coated on both sides Technical details page 79

Art.Gr. 216

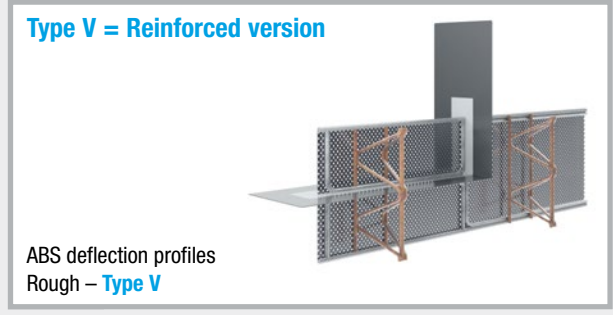
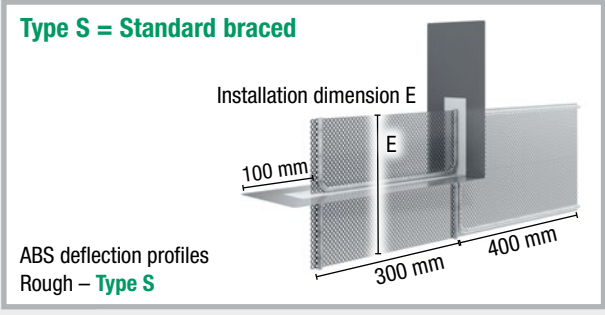

Description	Installation dimension E = Rib lath width	Type S = Standard braced		Type V = Reinforced version	
		Art. no.	Weight/pc.	Art. no.	Weight/pc.
ULP 130 rough	Up to 130 mm	070330	1.90 kg	070330V	2.35 kg
ULP 160 rough	140 – 160 mm	070333	1.95 kg	070333V	2.55 kg
ULP 200 rough	170 – 200 mm	070336	2.05 kg	070336V	2.75 kg
ULP 250 rough	210 – 250 mm	070339	2.15 kg	070339V	3.05 kg
ULP 300 rough	260 – 300 mm	070342	2.70 kg	070342V	3.75 kg
ULP 400 rough	310 – 400 mm	070345	3.05 kg	070345V	4.45 kg
ULP 500 rough	410 – 500 mm	070347	3.60 kg	070347V	5.40 kg
ULP 600 rough	510 – 600 mm	070349	3.85 kg	070349V	5.95 kg
ULP 700 rough	610 – 700 mm	070351	4.05 kg	070351V	6.50 kg
ULP 800 rough	710 – 800 mm	070353	4.60 kg	070353V	7.40 kg
ULP 900 rough	810 – 900 mm	070355	4.80 kg	070355V	8.00 kg
ULP 1000 rough	910 – 1000 mm	070357	5.00 kg	070357V	8.55 kg

All intermediate dimensions of the rib lath width available.
 Installation dimension E > 1000 mm available on request
 For proper formwork results, we recommend our ABS formwork comb type spacers.



All sizes also available in JGS (slurry/ liquid manure/silage effluent) version

Installation situation

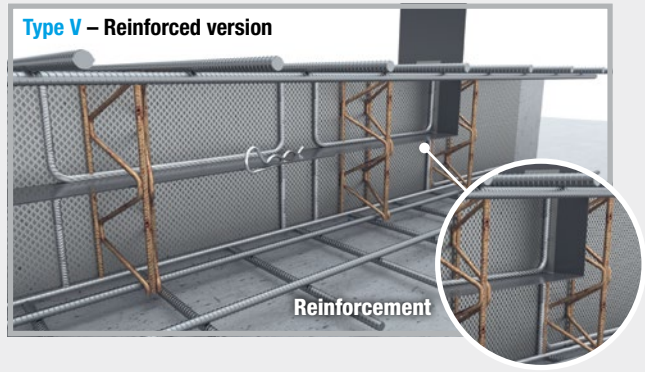
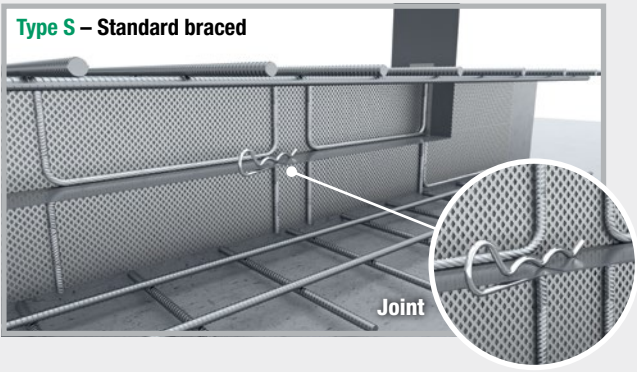

ABS corner profile (EP) toothed and rough

with joint sheet metal coated on both sides [Technical details page 80](#)

Art.Gr. 216

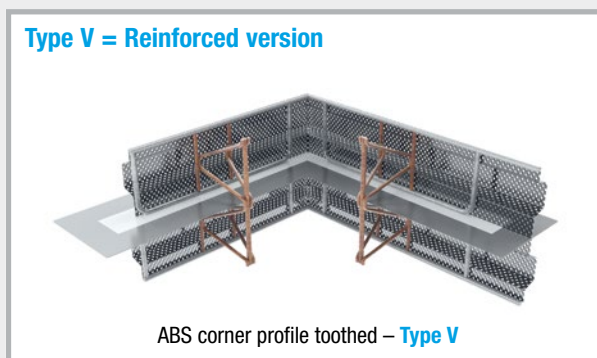
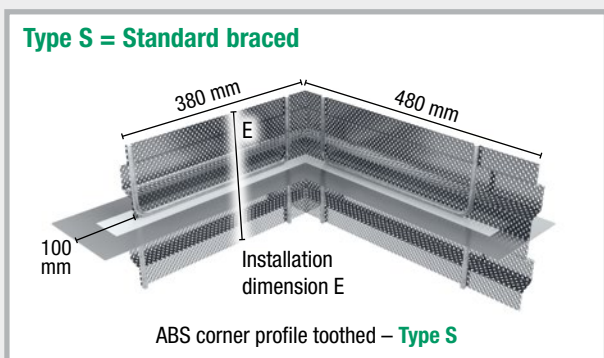

Corner profile (EP) toothed

Description	Installation dimension E = Rib lath width	Type S = Standard braced		Type V = Reinforced version	
		Art. no.	Weight/pc.	Art. no.	Weight/pc.
EP 160 toothed	Up to 160 mm	070740	2.40 kg	070740V	3.60 kg
EP 200 toothed	170 – 200 mm	070742	2.60 kg	070742V	3.90 kg
EP 250 toothed	210 – 250 mm	070744	2.75 kg	070744V	4.30 kg
EP 300 toothed	260 – 300 mm	070746	3.00 kg	070746V	4.70 kg
EP 400 toothed	310 – 400 mm	070748	3.45 kg	070748V	5.50 kg
EP 500 toothed	410 – 500 mm	070750	4.25 kg	070750V	6.65 kg
EP 600 toothed	510 – 600 mm	070752	4.50 kg	070752V	7.25 kg
EP 700 toothed	610 – 700 mm	070754	4.70 kg	070754V	7.80 kg
EP 800 toothed	710 – 800 mm	070756	5.50 kg	070756V	8.95 kg
EP 900 toothed	810 – 900 mm	070758	5.75 kg	070758V	9.55 kg
EP 1000 toothed	910 – 1000 mm	070760	5.95 kg	070760V	10.10 kg

Corner profile (EP) rough

Description	Installation dimension E = Rib lath width	Type S = Standard braced		Type V = Reinforced version	
		Art. no.	Weight/pc.	Art. no.	Weight/pc.
EP 130 rough	Up to 130 mm	070700	2.20 kg	070700V	3.30 kg
EP 160 rough	140 – 160 mm	070702	2.35 kg	070702V	3.55 kg
EP 200 rough	170 – 200 mm	070704	2.50 kg	070704V	3.85 kg
EP 250 rough	210 – 250 mm	070706	2.65 kg	070706V	4.15 kg
EP 300 rough	260 – 300 mm	070708	2.85 kg	070708V	4.55 kg
EP 400 rough	310 – 400 mm	070710	3.25 kg	070710V	5.30 kg
EP 500 rough	410 – 500 mm	070712	4.05 kg	070712V	6.45 kg
EP 600 rough	510 – 600 mm	070714	4.20 kg	070714V	6.95 kg
EP 700 rough	610 – 700 mm	070716	4.40 kg	070716V	7.50 kg
EP 800 rough	710 – 800 mm	070718	5.15 kg	070718V	8.60 kg
EP 900 rough	810 – 900 mm	070720	5.35 kg	070720V	9.15 kg
EP 1000 rough	910 – 1000 mm	070722	5.50 kg	070722V	9.70 kg

All intermediate dimensions of the rib lath width available.
Installation dimension E > 1000 mm available on request
For proper formwork results, we recommend our ABS formwork comb type spacers.



All sizes also available in JGS (slurry/ liquid manure/silage effluent) version

ABS T profile (TP) toothed and rough

Technical details page 80

Art.Gr. 216

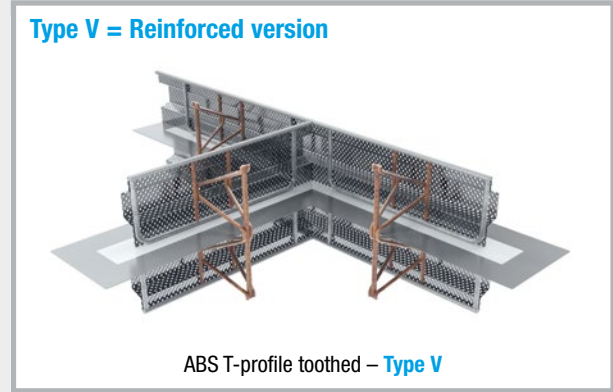
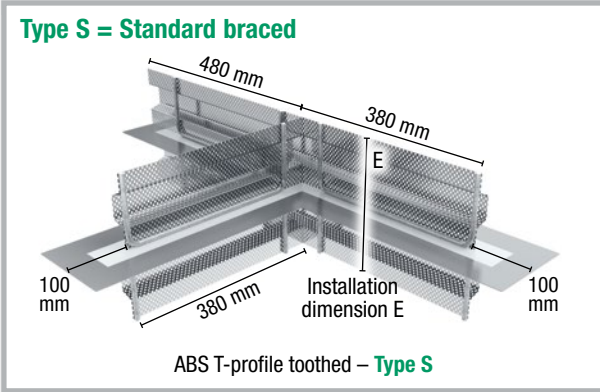

T profile (TP) toothed

Description	Installation dimension E = Rib lath width	Type S = Standard braced		Type V = Reinforced version	
		Art. no.	Weight/pc.	Art. no.	Weight/pc.
TP 160 toothed	Up to 160 mm	070830	3.40 kg	070830V	5.10 kg
TP 200 toothed	170 – 200 mm	070832	3.60 kg	070832V	5.55 kg
TP 250 toothed	210 – 250 mm	070834	3.90 kg	070834V	6.10 kg
TP 300 toothed	260 – 300 mm	070836	4.20 kg	070836V	6.70 kg
TP 400 toothed	310 – 400 mm	070838	4.85 kg	070838V	7.85 kg
TP 500 toothed	410 – 500 mm	070840	6.00 kg	070840V	9.55 kg
TP 600 toothed	510 – 600 mm	070842	6.30 kg	070842V	10.40 kg
TP 700 toothed	610 – 700 mm	070844	6.65 kg	070844V	11.25 kg
TP 800 toothed	710 – 800 mm	070846	7.80 kg	070846V	12.90 kg
TP 900 toothed	810 – 900 mm	070848	8.10 kg	070848V	13.75 kg
TP 1000 toothed	910 – 1000 mm	070850	8.45 kg	070850V	14.60 kg

T profile (TP) rough

Description	Installation dimension E = Rib lath width	Type S = Standard braced		Type V = Reinforced version	
		Art. no.	Weight/pc.	Art. no.	Weight/pc.
TP 130 rough	Up to 130 mm	070800	3.10 kg	070800V	4.65 kg
TP 160 rough	140 – 160 mm	070802	3.30 kg	070802V	5.00 kg
TP 200 rough	170 – 200 mm	070804	3.50 kg	070804V	5.45 kg
TP 250 rough	210 – 250 mm	070806	3.75 kg	070806V	5.95 kg
TP 300 rough	260 – 300 mm	070808	4.00 kg	070808V	6.50 kg
TP 400 rough	310 – 400 mm	070810	4.60 kg	070810V	7.60 kg
TP 500 rough	410 – 500 mm	070812	5.65 kg	070812V	9.20 kg
TP 600 rough	510 – 600 mm	070814	5.95 kg	070814V	10.00 kg
TP 700 rough	610 – 700 mm	070816	6.20 kg	070816V	10.80 kg
TP 800 rough	710 – 800 mm	070818	7.25 kg	070818V	12.40 kg
TP 900 rough	810 – 900 mm	070820	7.55 kg	070820V	13.20 kg
TP 1000 rough	910 – 1000 mm	070822	7.80 kg	070822V	13.95 kg

All intermediate dimensions of the rib lath width available.
 Installation dimension E > 1000 mm available on request
 For proper formwork results, we recommend our ABS formwork comb type spacers.



All sizes also available in JGS (slurry/ liquid manure/silage effluent) version

ABS cross profile (KP) toothed and rough

Technical details page 80

Art.Gr.
216

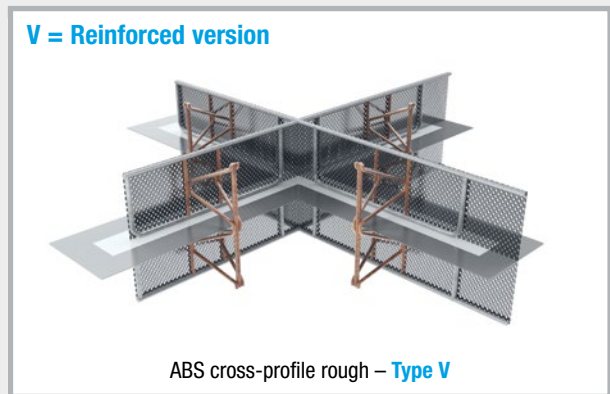
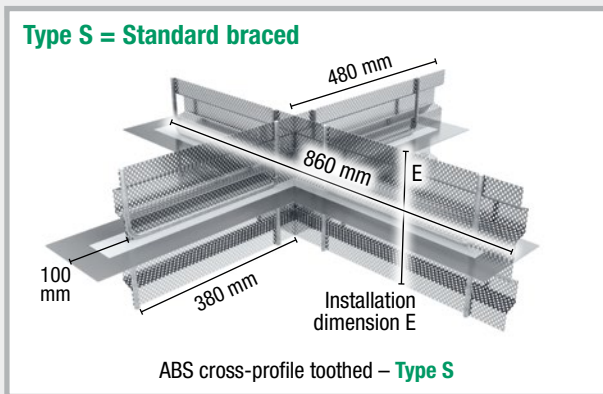

Cross profile (KP) toothed

Description	Installation dimension E = Rib lath width	Type S = Standard braced		V = Reinforced version	
		Art. no.	Weight/pc.	Art. no.	Weight/pc.
KP 160 toothed	Up to 160 mm	070878	4.45 kg	070878V	6.85 kg
KP 200 toothed	170 – 200 mm	070880	4.75 kg	070880V	7.45 kg
KP 250 toothed	210 – 250 mm	070882	5.10 kg	070882V	8.15 kg
KP 300 toothed	260 – 300 mm	070884	5.55 kg	070884V	8.95 kg
KP 400 toothed	310 – 400 mm	070886	6.40 kg	070886V	10.50 kg
KP 500 toothed	410 – 500 mm	070888	7.90 kg	070888V	12.70 kg
KP 600 toothed	510 – 600 mm	070890	8.35 kg	070890V	13.85 kg
KP 700 toothed	610 – 700 mm	070892	8.80 kg	070892V	15.00 kg
KP 800 toothed	710 – 800 mm	070894	10.30 kg	070894V	17.20 kg
KP 900 toothed	810 – 900 mm	070896	10.75 kg	070896V	18.35 kg
KP 1000 toothed	910 – 1000 mm	070898	11.20 kg	070898V	19.55 kg

Cross profile (KP) rough

Description	Installation dimension E = Rib lath width	Type S = Standard braced		V = Reinforced version	
		Art. no.	Weight/pc.	Art. no.	Weight/pc.
KP 130 rough	Up to 130 mm	070852	4.05 kg	070852V	6.25 kg
KP 160 rough	140 – 160 mm	070854	4.30 kg	070854V	6.70 kg
KP 200 rough	170 – 200 mm	070856	4.55 kg	070856V	7.25 kg
KP 250 rough	210 – 250 mm	070858	4.90 kg	070858V	7.95 kg
KP 300 rough	260 – 300 mm	070860	5.25 kg	070860V	8.65 kg
KP 400 rough	310 – 400 mm	070862	6.05 kg	070862V	10.15 kg
KP 500 rough	410 – 500 mm	070864	7.45 kg	070864V	12.25 kg
KP 600 rough	510 – 600 mm	070866	7.80 kg	070866V	13.30 kg
KP 700 rough	610 – 700 mm	070868	8.15 kg	070868V	14.40 kg
KP 800 rough	710 – 800 mm	070870	9.60 kg	070870V	16.50 kg
KP 900 rough	810 – 900 mm	070872	9.95 kg	070872V	17.55 kg
KP 1000 rough	910 – 1000 mm	070874	10.30 kg	070874V	18.65 kg

All intermediate dimensions of the rib lath width available.
Installation dimension E > 1000 mm available on request
For proper formwork results, we recommend our ABS formwork comb type spacers.



All sizes also available in JGS (slurry/liquid manure/silage effluent) version

Accessories/special versions

JOINT SHEET METAL ABS

Art. no.	Description	Schematic diagram
000354	ABS installation aid, one side (bottom) comprising 4 L brackets	
000356	ABS installation aid, both sides (top + bottom) comprising 4 L brackets, arranged opposed to each other on each side	
	Tapered, one side Rib lath wing with diagonal cut on one side	
	Tapered, both sides Rib lath wing with diagonal cut on both sides	
	Offset Rib lath wing with different heights	
	Special lengths Length of the element greater or less than stock length of 2.5 m	
	Recess (round and rectangular) Round or rectangular recesses in the rib lath wing produced in the factory	

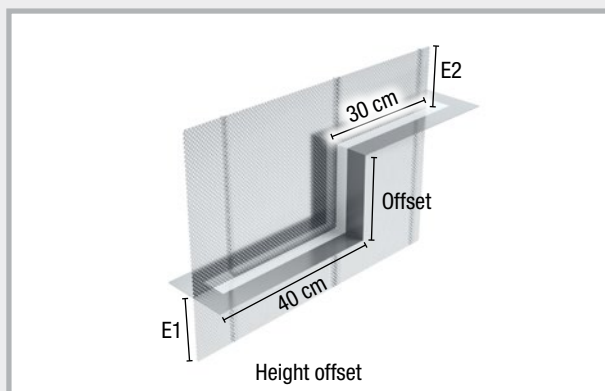

ABS spacer

ABS spacer, “formwork comb” type

Art.Gr. 219

Fibre cement square spacer with integrated formwork comb

- Compliant with German WU directive for Water-Impermeable Concrete Buildings

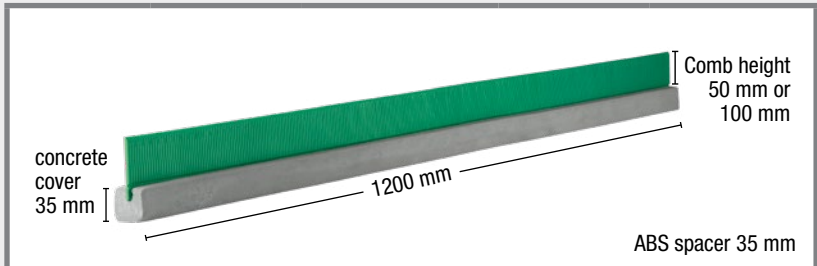

Description	Length	PU	Secondary packaging	Art. no.	Weight per pc.
ABS spacer 35/50 mm “Formwork comb” type, concrete cover 35 mm, Comb height 50 mm	1.2 m	1 pc.	1 pallet = 276 pcs.	070645	2.90 kg
NEW! ABS spacer 35/100 mm “Formwork comb” type, concrete cover 35 mm, Comb height 100 mm	1.2 m	1 pc.	1 pallet = 184 pcs.	070643	3.20 kg
ABS spacer 40/50 mm “Formwork comb” type, Concrete cover 40 mm, Comb height 50 mm	1.2 m	1 pc.	1 pallet = 228 pcs.	070647	3.80 kg
NEW! ABS spacer 40/100 mm “Formwork comb” type, Concrete cover 40 mm, Comb height 100 mm	1.2 m	1 pc.	1 pallet = 152 pcs.	070646	4.10 kg
ABS spacer 50/50 mm “Formwork comb” type, Concrete cover 50 mm, Comb height 50 mm	1.2 m	1 pc.	1 pallet = 140 pcs.	070649	6.10 kg
NEW! ABS spacer 50/100 mm “Formwork comb” type, Concrete cover 50 mm, Comb height 100 mm	1.2 m	1 pc.	1 pallet = 84 pcs.	070648	6.40 kg

By positioning the ABS spacer type formwork comb below the longitudinal direction of stopend panels, the comb minimises the discharge of concrete in the area of the lower reinforcement layer. The teeth of the comb are only displaced in the support area of the reinforcement; the open area between and below the lower layer of reinforcement is therefore reduced.

The comb height must be selected in accordance with the height of the reinforcement structure:

Reinforcement structure up to 40 mm = comb height 50 mm

Reinforcement structure up to 90 mm = comb height 100 mm

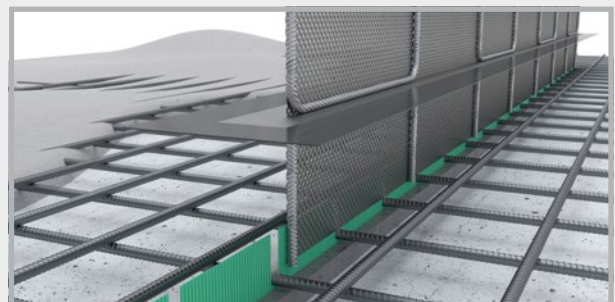
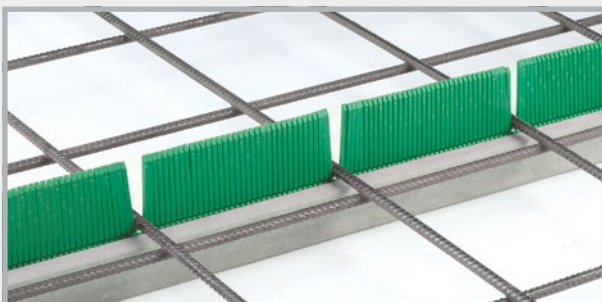

The formwork comb is arranged facing the first concreting section.

Formwork comb – SOLO

Formwork aid for the upper reinforcement layer

Art.Gr. 219

By positioning the formwork comb above the longitudinal direction of stopend panels, the comb minimises the discharge of concrete in the area of the upper reinforcement layer. The teeth of the formwork comb are only displaced in the support area of the reinforcement; the open area between the layer of reinforcement is therefore reduced.

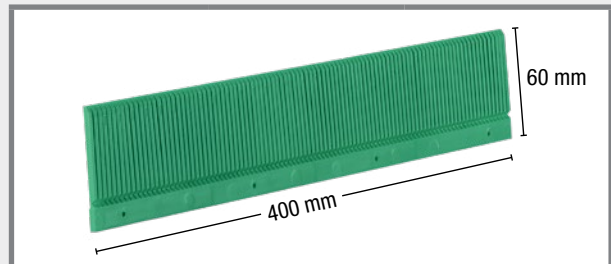

Description	Length	PU	Art. no.	Weight/pc.
Formwork comb – SOLO, 50 mm	0.4 m	1 pc.	070644	0.06 kg
NEW! Formwork comb – SOLO, 100 mm	0.4 m	1 pc.	070642	0.12 kg



With nail holes, for simple installation



Position, align and anchor back the square timber

ABS spacer, rib lath type “Fix”

Fibre cement square spacer with integrated rib lath

Art.Gr. 219

By positioning the ABS spacer below the longitudinal direction of stopend panels, the rib lath minimises the discharge of concrete in the area of the lower reinforcement layer. The variant “Fix” is pre-fabricated to meet your specifications.

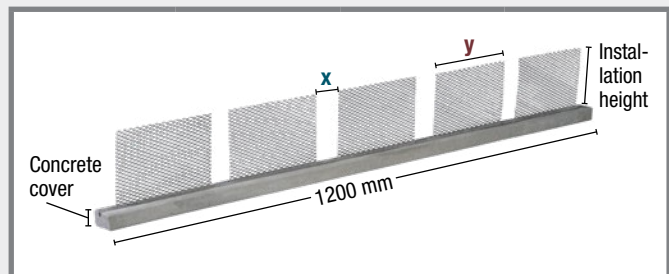

Description	Length	PU	Installation height 120		Installation height 150	
			Art. no.	Weight per pc.	Art. no.	Weight per pc.
ABS spacer 35 mm type “Fix” E height 120/150-x-y	1.2 m	1 pc.	070630	3.20 kg	070636	3.40 kg
ABS spacer 40 mm, type “Fix” Installation height 120/150-x-y	1.2 m	1 pc.	070632	3.60 kg	070638	3.80 kg
ABS spacer 50 mm, type “Fix” Installation height 120/150-x-y	1.2 m	1 pc.	070634	6.50 kg	070640	6.70 kg

To adapt the ABS spacers perfectly to your installation situation, we need, in addition to the installation height, the reinforcement width **x** and the formwork width **y**.

ABS crack-inducing elements

NEW! ABS crack-inducing elements toothed

with bracing and mounting rim,
maximum joint opening 1.0 mm

Art.Gr.
233

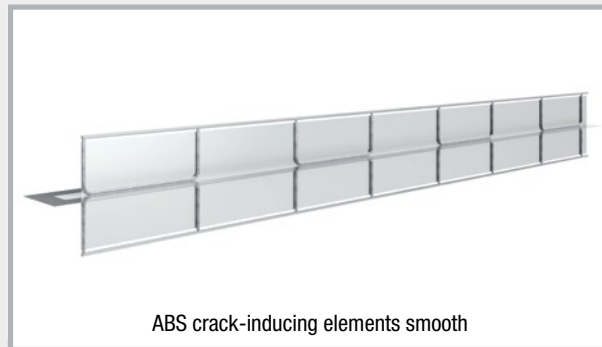
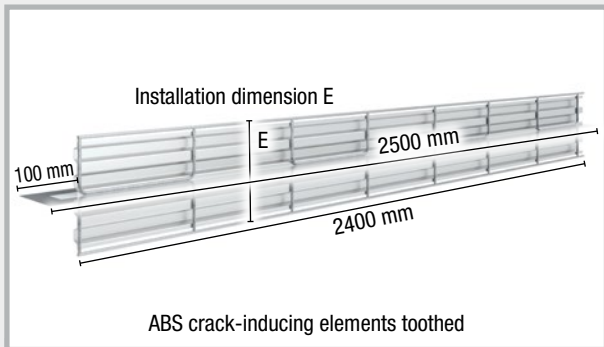

Description	E = Rib lath width	Length	Art. no.	Weight/pc.
ABS crack-inducing elements 160 toothed	Up to 160 mm	2.5 m	070362S	8.25 kg
ABS crack-inducing elements 200 toothed	170 – 200 mm	2.5 m	070364S	8.95 kg
ABS crack-inducing elements 250 toothed	210 – 250 mm	2.5 m	070366S	9.80 kg
ABS crack-inducing elements 300 toothed	260 – 300 mm	2.5 m	070368S	10.70 kg
ABS crack-inducing elements 400 toothed	310 – 400 mm	2.5 m	070370S	12.45 kg
ABS crack-inducing elements 500 toothed	410 – 500 mm	2.5 m	070372S	14.90 kg
ABS crack-inducing elements 600 toothed	510 – 600 mm	2.5 m	070374S	16.25 kg
ABS crack-inducing elements 700 toothed	610 – 700 mm	2.5 m	070376S	17.65 kg
ABS crack-inducing elements 800 toothed	710 – 800 mm	2.5 m	070378S	20.05 kg
ABS crack-inducing elements 900 toothed	810 – 900 mm	2.5 m	070380S	21.45 kg
ABS crack-inducing elements 1000 toothed	910 – 1000 mm	2.5 m	070382S	22.80 kg

Technical details page 81

All intermediate dimensions of the rib lath width available.
Installation dimension E > 1000 mm available on request

NEW! ABS crack-inducing elements smooth

with bracing and mounting rim,
maximum joint opening 1.0 mm

Art.Gr.
233

Description	E = Rib lath width	Length	Art. no.	Weight/pc.
ABS crack-inducing elements 130 smooth	Up to 130 mm	2.5 m	070281S	7.45 kg
ABS crack-inducing elements 160 smooth	140 – 160 mm	2.5 m	070282S	7.95 kg
ABS crack-inducing elements 200 smooth	170 – 200 mm	2.5 m	070284S	8.55 kg
ABS crack-inducing elements 250 smooth	210 – 250 mm	2.5 m	070287S	9.30 kg
ABS crack-inducing elements 300 smooth	260 – 300 mm	2.5 m	070289S	10.05 kg
ABS crack-inducing elements 400 smooth	310 – 400 mm	2.5 m	070291S	11.60 kg
ABS crack-inducing elements 500 smooth	410 – 500 mm	2.5 m	070293S	13.85 kg
ABS crack-inducing elements 600 smooth	510 – 600 mm	2.5 m	070295S	15.00 kg
ABS crack-inducing elements 700 smooth	610 – 700 mm	2.5 m	070297S	16.15 kg
ABS crack-inducing elements 800 smooth	710 – 800 mm	2.5 m	070299S	18.35 kg
ABS crack-inducing elements 900 smooth	810 – 900 mm	2.5 m	070301S	19.50 kg
ABS crack-inducing elements 1000 smooth	910 – 1000 mm	2.5 m	070303S	20.65 kg

Technical details page 81

All intermediate dimensions of the rib lath width available.
Installation dimension E > 1000 mm available on request

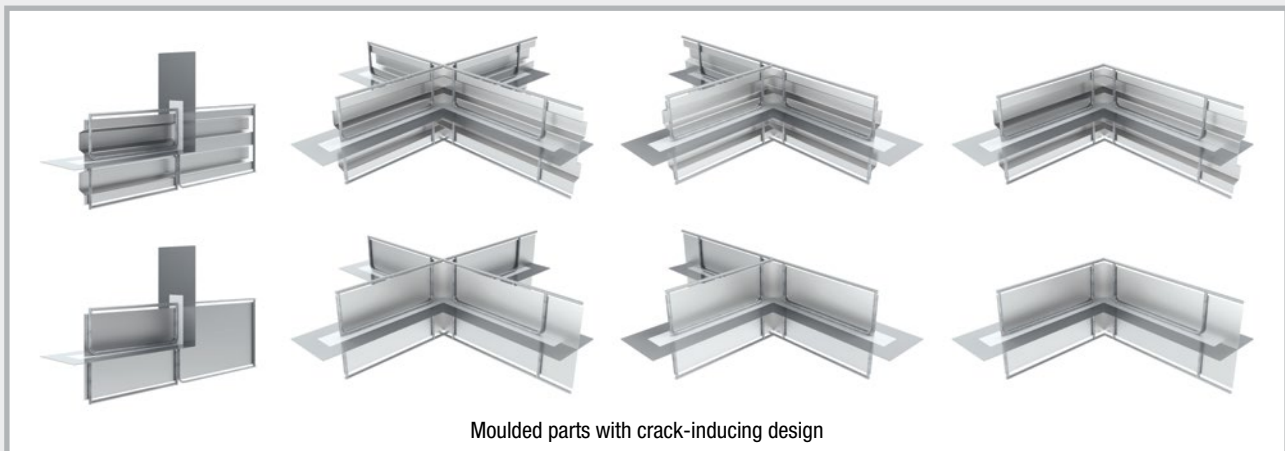

All accessories, e.g. deflection profile, cross profile, T profile and corner profile, can be produced with a crack-inducing design as toothed and smooth variant.

Stopend panels UNCOATED JOINT SHEET METAL

Stopend panels UNCOATED JOINT SHEET METAL toothed

Uncoated joint sheet metal as recommended by the WU Guideline

Joint category: toothed, according to DIN EN 1992-1-1 NA (EC2)

Art.Gr.
218

Type S = Standard

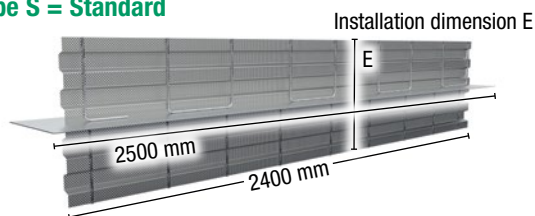

Stopend panels UNCOATED JOINT SHEET METAL toothed – Type S

Type V = Reinforced version



Stopend panels UNCOATED JOINT SHEET METAL toothed – Type V

Description	Installation dimension E = Rib lath width	Art. no.	Joint sheet metal 1,5 x 250 mm		Joint sheet metal 1,5 x 300 mm		Joint sheet metal 2,0 x 250 mm		Joint sheet metal 2,0 x 300 mm	
			Type S	Type V	Type S	Type V	Type S	Type V	Type S	Type V
FB ABS 160 toothed	up to 160 mm	Art. no. Weight	071100 9.75 kg	071100V 12.90 kg	071122 11.25 kg	071122V 14.35 kg	071144 12.10 kg	071144V 15.20 kg	071166 14.05 kg	071166V 17.20 kg
FB ABS 200 toothed	170-200 mm	Art. no. Weight	071102 10.15 kg	071102V 13.60 kg	071124 11.65 kg	071124V 15.10 kg	071146 12.50 kg	071146V 15.95 kg	071168 14.45 kg	071168V 17.90 kg
FB ABS 250 toothed	210-250 mm	Art. no. Weight	071104 10.60 kg	071104V 14.45 kg	071126 12.10 kg	071126V 16.00 kg	071148 12.95 kg	071148V 16.80 kg	071170 14.90 kg	071170V 18.75 kg
FB ABS 300 toothed	260-300 mm	Art. no. Weight	071106 11.10 kg	071106V 15.40 kg	071128 12.60 kg	071128V 16.90 kg	071150 13.45 kg	071150V 17.75 kg	071172 15.40 kg	071172V 19.70 kg
FB ABS 400 toothed	310-400 mm	Art. no. Weight	071108 12.15 kg	071108V 17.25 kg	071130 13.65 kg	071130V 18.75 kg	071152 14.50 kg	071152V 19.60 kg	071174 16.45 kg	071174V 21.55 kg
FB ABS 500 toothed	410-500 mm	Art. no. Weight	071110 13.85 kg	071110V 19.80 kg	071132 15.30 kg	071132V 21.25 kg	071154 16.20 kg	071154V 22.10 kg	071176 18.15 kg	071176V 24.10 kg
FB ABS 600 toothed	510-600 mm	Art. no. Weight	071112 14.45 kg	071112V 21.25 kg	071134 15.95 kg	071134V 22.70 kg	071156 16.80 kg	071156V 23.55 kg	071178 18.75 kg	071178V 25.55 kg
FB ABS 700 toothed	610-700 mm	Art. no. Weight	071114 15.10 kg	071114V 22.70 kg	071136 16.55 kg	071136V 24.15 kg	071158 17.45 kg	071158V 25.10 kg	071180 19.40 kg	071180V 27.00 kg
FB ABS 800 toothed	710-800 mm	Art. no. Weight	071116 16.75 kg	071116V 25.20 kg	071138 18.25 kg	071138V 26.65 kg	071160 19.10 kg	071160V 27.55 kg	071182 21.05 kg	071182V 29.50 kg
FB ABS 900 toothed	810-900 mm	Art. no. Weight	071118 17.40 kg	071118V 26.65 kg	071140 18.85 kg	071140V 28.15 kg	071162 19.75 kg	071162V 29.00 kg	071184 21.70 kg	071184V 30.95 kg
FB ABS 1000 toothed	910-1000 mm	Art. no. Weight	071120 18.00 kg	071120V 28.10 kg	071142 19.50 kg	071142V 29.60 kg	071164 20.35 kg	071164V 30.45 kg	071186 22.30 kg	071186V 32.40 kg

All intermediate dimensions of the rib lath width available.

Installation dimension E > 1000 mm available on request

For proper formwork results, we recommend our ABS formwork comb type spacers.

Stopend panels UNCOATED JOINT SHEET METAL rough

Uncoated joint sheet metal as recommended by the WU Guideline

Joint category: rough, according to DIN EN 1992-1-1 NA (EC2)

Art.Gr.
218

Type S = Standard

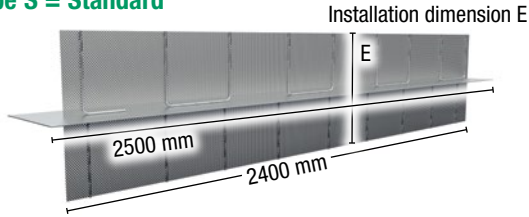

Stopend panels UNCOATED JOINT SHEET METAL rough – Type S

Type V = Reinforced version



Stopend panels UNCOATED JOINT SHEET METAL rough – Type V

Description	Installation dimension E = Rib lath width		Joint sheet metal 1,5 x 250 mm		Joint sheet metal 1,5 x 300 mm		Joint sheet metal 2,0 x 250 mm		Joint sheet metal 2,0 x 300 mm	
			Type S	Type V	Type S	Type V	Type S	Type V	Type S	Type V
FB ABS 130 rough	up to 130 mm	Art. no.	071000	071000V	071026	071026V	071050	071050V	071074	071074V
		Weight	9.25 kg	12.15 kg	10.75 kg	13.60 kg	11.60 kg	14.45 kg	13.55 kg	16.45 kg
FB ABS 160 rough	140-160 mm	Art. no.	071002	071002V	071028	071028V	071052	071052V	071076	071076V
		Weight	9.55 kg	12.70 kg	11.05 kg	14.15 kg	11.90 kg	15.00 kg	13.85 kg	17.00 kg
FB ABS 200 rough	170-200 mm	Art. no.	071004	071004V	071030	071030V	071054	071054V	071078	071078V
		Weight	9.90 kg	13.35 kg	11.40 kg	14.85 kg	12.25 kg	15.70 kg	14.20 kg	17.65 kg
FB ABS 250 rough	210-250 mm	Art. no.	071006	071006V	071032	071032V	071056	071056V	071080	071080V
		Weight	10.30 kg	14.15 kg	11.75 kg	15.65 kg	12.65 kg	16.50 kg	14.60 kg	18.45 kg
FB ABS 300 rough	260-300 mm	Art. no.	071008	071008V	071034	071034V	071058	071058V	071082	071082V
		Weight	10.75 kg	15.05 kg	12.20 kg	16.50 kg	13.10 kg	17.35 kg	15.05 kg	19.35 kg
FB ABS 400 rough	310-400 mm	Art. no.	071010	071010V	071036	071036V	071060	071060V	071084	071084V
		Weight	11.65 kg	16.75 kg	13.15 kg	18.25 kg	14.00 kg	19.10 kg	15.95 kg	21.10 kg
FB ABS 500 rough	410-500 mm	Art. no.	071012	071012V	071038	071038V	071062	071062V	071086	071086V
		Weight	13.20 kg	19.15 kg	14.70 kg	20.65 kg	15.60 kg	21.50 kg	17.50 kg	23.45 kg
FB ABS 600 rough	510-600 mm	Art. no.	071014	071014V	071040	071040V	071064	071064V	071088	071088V
		Weight	13.70 kg	20.50 kg	15.20 kg	21.95 kg	16.05 kg	22.80 kg	18.00 kg	24.80 kg
FB ABS 700 rough	610-700 mm	Art. no.	071016	071016V	071042	071042V	071066	071066V	071090	071090V
		Weight	14.20 kg	21.80 kg	15.70 kg	23.30 kg	16.55 kg	24.15 kg	18.50 kg	26.10 kg
FB ABS 800 rough	710-800 mm	Art. no.	071018	071018V	071044	071044V	071068	071068V	071092	071092V
		Weight	15.75 kg	24.20 kg	17.25 kg	25.65 kg	18.10 kg	26.55 kg	20.05 kg	28.50 kg
FB ABS 900 rough	810-900 mm	Art. no.	071020	071020V	071046	071046V	071070	071070V	071094	071094V
		Weight	16.25 kg	25.55 kg	17.75 kg	27.00 kg	18.60 kg	27.85 kg	20.55 kg	29.85 kg
FB ABS 1000 rough	910-1000 mm	Art. no.	071022	071022V	071048	071048V	071072	071072V	071096	071096V
		Weight	16.75 kg	26.85 kg	18.25 kg	28.35 kg	19.10 kg	29.20 kg	21.05 kg	31.15 kg

All intermediate dimensions of the rib lath width available.

Installation dimension E > 1000 mm available on request

For proper formwork results, we recommend our ABS formwork comb type spacers.



Deflection profile for stopend panels UNCOATED JOINT SHEET METAL available on request

LinkFix stopend panels

Lost formwork/crack-inducing profiles for construction joints in the toothed joint category according to DIN EN 1992-1-1 NA (EC2), prefabricated ready for installation

Type S = Formwork strips

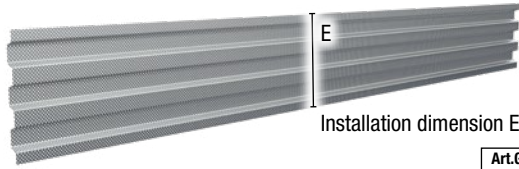

LinkFix stopend panel – Type S

Art.Gr. 217

Type V = braced

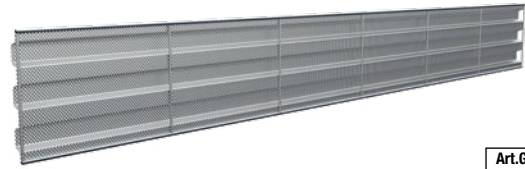

LinkFix stopend panel – Type V

Art.Gr. 217

Type VV = braced + reinforced



LinkFix stopend panel – Type VV

Art.Gr. 217

NEW! Type SRE = crack-inducing element

Technical details page 82



LinkFix stopend panel – Type SRE

Art.Gr. 234

Element length: 2.4 m

E dimension > 800 mm available on request
All intermediate dimensions of the rib lath width available

Description	Installation dimension	Type S = Formwork strips		Type V = braced	
		Art. no.	Weight per pc.	Art. no.	Weight per pc.
LinkFix 130 toothed	Up to 130 mm	070556	0.81 kg	070576	2.80 kg
LinkFix 160 toothed	140 – 160 mm	070558	1.00 kg	070578	3.05 kg
LinkFix 200 toothed	170 – 200 mm	070560	1.25 kg	070580	3.35 kg
LinkFix 250 toothed	210 – 250 mm	070562	1.60 kg	070582	3.75 kg
LinkFix 300 toothed	260 – 300 mm	070564	1.90 kg	070584	4.15 kg
LinkFix 400 toothed	310 – 400 mm	070566	2.50 kg	070586	4.90 kg
LinkFix 500 toothed	410 – 500 mm	070568	3.15 kg	070588	5.70 kg
LinkFix 600 toothed	510 – 600 mm	070570	3.75 kg	070590	6.50 kg
LinkFix 700 toothed	610 – 700 mm	070572	4.40 kg	070592	7.25 kg
LinkFix 800 toothed	710 – 800 mm	020050 LinkFix sheets (page 37)		070594	8.05 kg

Description	Installation dimension	Type VV = braced + reinforced		NEW! Type SRE = crack-inducing	
		Art. no.	Weight per pc.	Art. no.	Weight per pc.
LinkFix 130 toothed	Up to 130 mm	070576V	3.70 kg	070576S	3.50 kg
LinkFix 160 toothed	140 – 160 mm	070578V	4.15 kg	070578S	3.90 kg
LinkFix 200 toothed	170 – 200 mm	070580V	4.75 kg	070580S	4.40 kg
LinkFix 250 toothed	210 – 250 mm	070582V	5.50 kg	070582S	5.05 kg
LinkFix 300 toothed	260 – 300 mm	070584V	6.25 kg	070584S	5.70 kg
LinkFix 400 toothed	310 – 400 mm	070586V	7.75 kg	070586S	6.70 kg
LinkFix 500 toothed	410 – 500 mm	070588V	9.20 kg	070588S	8.30 kg
LinkFix 600 toothed	510 – 600 mm	070590V	10.70 kg	070590S	9.60 kg
LinkFix 700 toothed	610 – 700 mm	070592V	12.20 kg	070592S	10.90 kg
LinkFix 800 toothed	710 – 800 mm	070594V	13.70 kg	070594S	12.20 kg

1 SWELLING TAPES
2 JOINT SHEET METALS
3 INJECTION HOSES CONSTRUCTION CHEMISTRY
4 SERVICE DUCTS
5 LIGHTNING PROTECTION
6 FORMWORK ACCESSORIES

LinkForm stopend panels

Lost formwork/crack-inducing profiles for construction joints in the rough joint category according to DIN EN 1992-1-1 NA (EC2), prefabricated ready for installation

Type S = Formwork strips

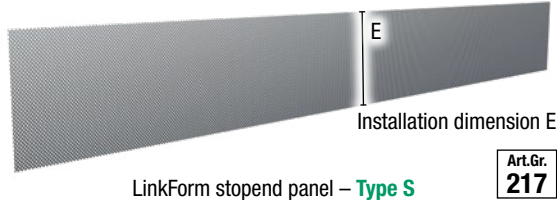

Type V = braced

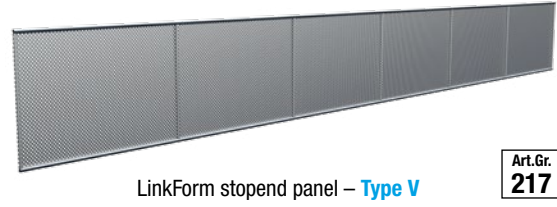

Type VV = braced + reinforced



NEW! Type SRE = crack-inducing element

Technical details page 82

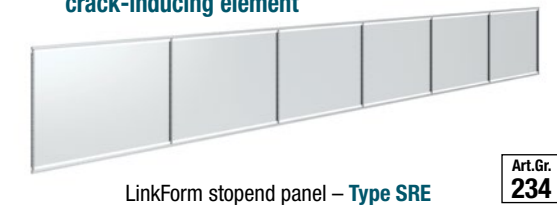

Element length: 2.4 m

E dimension > 800 mm available on request
All intermediate dimensions of the rib lath width available

Description	Installation dimension	Type S = Formwork strips		Type V = braced	
		Art. no.	Weight per pc.	Art. no.	Weight per pc.
LinkForm 130 rough	Up to 130 mm	070500	0.65 kg	070530	2.65 kg
LinkForm 160 rough	140 – 160 mm	070502	0.80 kg	070532	2.85 kg
LinkForm 200 rough	170 – 200 mm	070504	1.00 kg	070534	3.10 kg
LinkForm 250 rough	210 – 250 mm	070506	1.25 kg	070536	3.45 kg
LinkForm 300 rough	260 – 300 mm	070508	1.50 kg	070538	3.75 kg
LinkForm 400 rough	310 – 400 mm	070512	2.00 kg	070540	4.40 kg
LinkForm 500 rough	410 – 500 mm	070514	2.50 kg	070544	5.05 kg
LinkForm 600 rough	510 – 600 mm	070516	3.00 kg	070546	5.75 kg
LinkForm 700 rough	610 – 700 mm	070518	3.50 kg	070548	6.40 kg
LinkForm 800 rough	710 – 800 mm	070519	4.00 kg	070550	7.05 kg

Description	Installation dimension	Type VV = braced + reinforced		NEW! Type SRE = crack-inducing	
		Art. no.	Weight per pc.	Art. no.	Weight per pc.
LinkForm 130 rough	Up to 130 mm	070530V	3.55 kg	070530S	3.30 kg
LinkForm 160 rough	140 – 160 mm	070532V	3.95 kg	070532S	3.65 kg
LinkForm 200 rough	170 – 200 mm	070534V	4.50 kg	070534S	4.10 kg
LinkForm 250 rough	210 – 250 mm	070536V	5.20 kg	070536S	4.70 kg
LinkForm 300 rough	260 – 300 mm	070538V	5.85 kg	070538S	5.25 kg
LinkForm 400 rough	310 – 400 mm	070540V	7.25 kg	070540S	6.40 kg
LinkForm 500 rough	410 – 500 mm	070544V	8.60 kg	070544S	7.55 kg
LinkForm 600 rough	510 – 600 mm	070546V	9.95 kg	070546S	8.70 kg
LinkForm 700 rough	610 – 700 mm	070548V	11.30 kg	070548S	9.85 kg
LinkForm 800 rough	710 – 800 mm	070550V	12.70 kg	070550S	11.00 kg

For proper formwork results, we recommend our ABS formwork comb type spacers.

ABS joint sheet metal cage

ABS joint sheet metal cage toothed

Stopend panel for retrofitting joint sheet metal

Joint category: toothed, according to DIN EN 1992-1-1 NA (EC2)

Art.Gr.
225

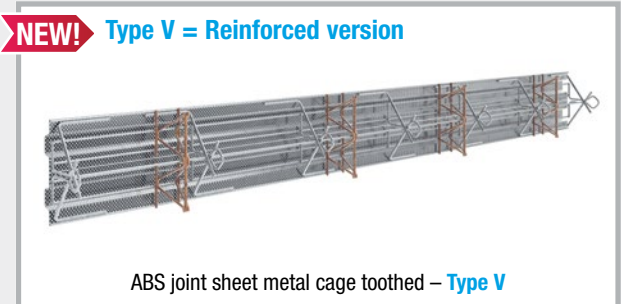
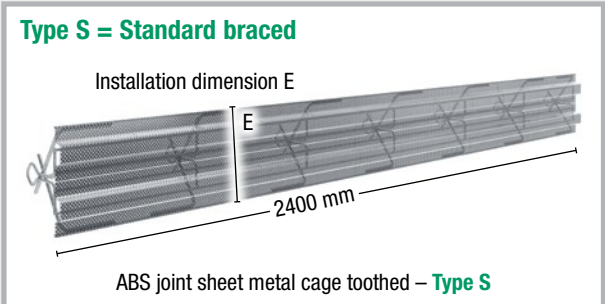

Element length: 2.4 m

Description	Installation dimension E = Rib lath width	Type S = Standard braced		NEW! Type V = Reinforced version	
		Art. no.	Weight per pc.	Art. no.	Weight per pc.
ABS joint sheet metal cage 160 toothed	Up to 160 mm	071230	8.20 kg	–	–
ABS joint sheet metal cage 200 toothed	170 – 200 mm	071232	9.30 kg	071232V	10.95 kg
ABS joint sheet metal cage 250 toothed	210 – 250 mm	071234	9.60 kg	071234V	11.70 kg
ABS joint sheet metal cage 300 toothed	260 – 300 mm	071236	10.15 kg	071236V	12.65 kg
ABS joint sheet metal cage 400 toothed	310 – 400 mm	071238	11.70 kg	071238V	15.00 kg
ABS joint sheet metal cage 500 toothed	410 – 500 mm	071240	12.30 kg	071240V	16.45 kg
ABS joint sheet metal cage 600 toothed	510 – 600 mm	071242	12.95 kg	071242V	17.90 kg
ABS joint sheet metal cage 700 toothed	610 – 700 mm	071244	13.55 kg	071244V	19.40 kg
ABS joint sheet metal cage 800 toothed	710 – 800 mm	071246	14.20 kg	071246V	20.85 kg
ABS joint sheet metal cage 900 toothed	810 – 900 mm	071248	14.80 kg	071248V	22.30 kg
ABS joint sheet metal cage 1000 toothed	910 – 1000 mm	071250	15.45 kg	071250V	23.75 kg

Technical details page 83

All intermediate dimensions of the rib lath width available.
Installation dimension E > 1000 mm available on request
For proper formwork results, we recommend our ABS formwork comb type spacers.

You can also use all accessories, e.g. deflection profile, cross profile, T profile and corner profile, in conjunction with the ABS joint sheet metal cage. You will find an overview on pages 42 to 46.

ABS joint sheet metal cage rough

Sto pend panel for retrofitting joint sheet metal

Joint category: rough, according to DIN EN 1992-1-1 NA (EC2)

Art.Gr. 225

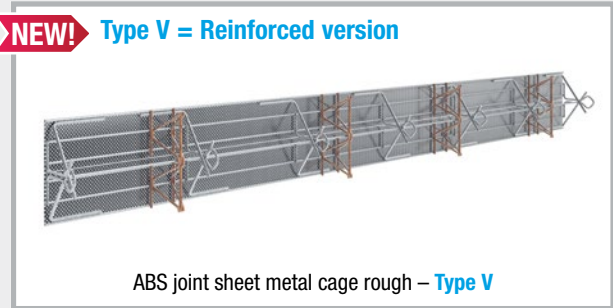
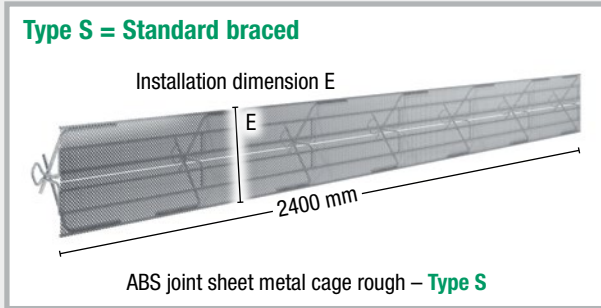

Element length: 2.4 m

Description	Installation dimension E = Rib lath width	Type S = Standard braced		NEW! Type V = Reinforced version	
		Art. no.	Weight per pc.	Art. no.	Weight per pc.
ABS joint sheet metal cage 130 rough	Up to 130 mm	071200	6.95 kg	–	–
ABS joint sheet metal cage 160 rough	140-160 mm	071202	7.10 kg	–	–
ABS joint sheet metal cage 200 rough	170 – 200 mm	071204	7.30 kg	071204V	8.95 kg
ABS joint sheet metal cage 250 rough	210 – 250 mm	071206	8.45 kg	071206V	10.50 kg
ABS joint sheet metal cage 300 rough	260 – 300 mm	071208	9.80 kg	071208V	12.30 kg
ABS joint sheet metal cage 400 rough	310 – 400 mm	071210	11.20 kg	071210V	14.55 kg
ABS joint sheet metal cage 500 rough	410 – 500 mm	071212	11.70 kg	071212V	15.85 kg
ABS joint sheet metal cage 600 rough	510 – 600 mm	071214	12.20 kg	071214V	17.20 kg
ABS joint sheet metal cage 700 rough	610 – 700 mm	071216	12.70 kg	071216V	18.50 kg
ABS joint sheet metal cage 800 rough	710 – 800 mm	071218	13.20 kg	071218V	19.85 kg
ABS joint sheet metal cage 900 rough	810 – 900 mm	071220	13.70 kg	071220V	21.15 kg
ABS joint sheet metal cage 1000 rough	910 – 1000 mm	071222	14.20 kg	071222V	22.50 kg

Technical details page 83

All intermediate dimensions of the rib lath width available.

Installation dimension E > 1000 mm available on request

For proper formwork results, we recommend our ABS formwork comb type spacers.

You can also use all accessories, e.g. deflection profile, cross profile, T profile and corner profile, in conjunction with the ABS joint sheet metal cage. You will find an overview on pages 42 to 46.

ABS joint tape cage

NEW! ABS joint tape cage toothed

Sto pend panel for retrofitting joint tapes

Joint category: toothed, according to DIN EN 1992-1-1 NA (EC2)

Art.Gr.
232

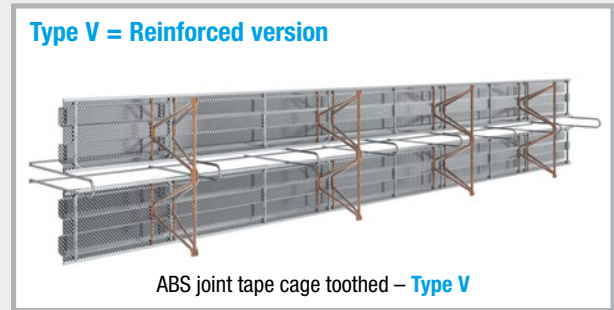
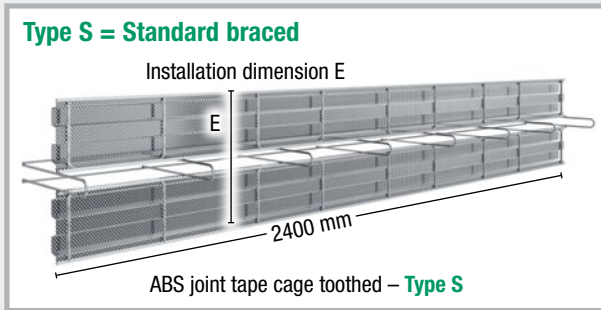

Element length: 2.4 m

Description	Installation dimension E = Rib lath width	Type S = Standard braced		Type V = Reinforced version	
		Art. no.	Weight per pc.	Art. no.	Weight per pc.
ABS joint tape cage 160 toothed	Up to 160 mm	070922	8.00 kg	–	–
ABS joint tape cage 200 toothed	170 – 200 mm	070923	8.40 kg	070923V	10.05 kg
ABS joint tape cage 250 toothed	210 – 250 mm	070924	8.85 kg	070924V	10.95 kg
ABS joint tape cage 300 toothed	260 – 300 mm	070925	9.35 kg	070925V	11.85 kg
ABS joint tape cage 400 toothed	310 – 400 mm	070926	10.40 kg	070926V	13.75 kg
ABS joint tape cage 500 toothed	410 – 500 mm	070927	12.10 kg	070927V	16.25 kg
ABS joint tape cage 600 toothed	510 – 600 mm	070928	12.70 kg	070928V	17.70 kg
ABS joint tape cage 700 toothed	610 – 700 mm	070929	13.35 kg	070929V	19.15 kg
ABS joint tape cage 800 toothed	710 – 800 mm	070930	15.00 kg	070930V	21.65 kg
ABS joint tape cage 900 toothed	810 – 900 mm	070931	15.65 kg	070931V	23.10 kg
ABS joint tape cage 1000 toothed	910 – 1000 mm	070932	16.25 kg	070932V	24.55 kg

Technical details page 84

All intermediate dimensions of the rib lath width available.
Installation dimension E > 1000 mm available on request

For proper formwork results, we recommend our ABS formwork comb type spacers.

When ordering, please specify the joint tape width (190, 240 or 320 mm).
You will find the suitable joint tapes on page 34. A separate order is required.

NEW! ABS joint tape cage rough

Stopend panel for retrofitting joint tapes

Joint category: rough, according to DIN EN 1992-1-1 NA (EC2)

Art.Gr.
232

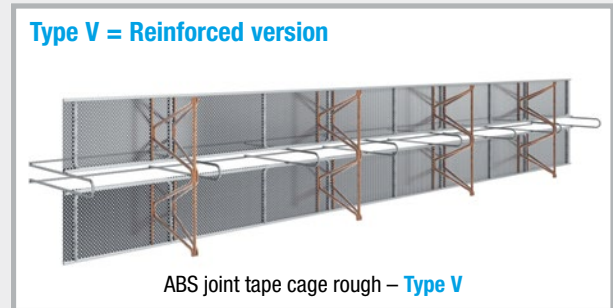
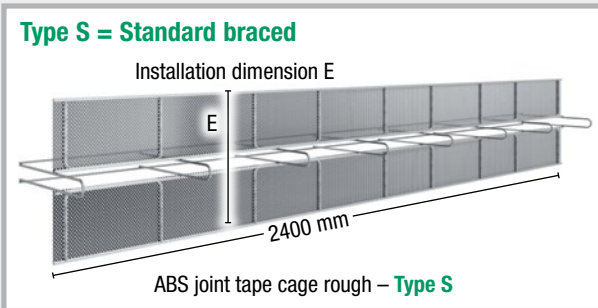

Element length: 2.4 m

All intermediate dimensions of the rib lath width available

Description	Installation dimension E = Rib lath width	Type S = Standard braced		Type V = Reinforced version	
		Art. no.	Weight per pc.	Art. no.	Weight per pc.
ABS joint tape cage 130 rough	Up to 130 mm	070910	7.55 kg	-	-
ABS joint tape cage 160 rough	140-160 mm	070911	7.85 kg	-	-
ABS joint tape cage 200 rough	170 – 200 mm	070912	8.20 kg	070912V	9.85 kg
ABS joint tape cage 250 rough	210 – 250 mm	070913	8.60 kg	070913V	10.65 kg
ABS joint tape cage 300 rough	260 – 300 mm	070914	9.05 kg	070914V	11.50 kg
ABS joint tape cage 400 rough	310 – 400 mm	070915	9.95 kg	070915V	13.25 kg
ABS joint tape cage 500 rough	410 – 500 mm	070916	11.50 kg	070916V	15.65 kg
ABS joint tape cage 600 rough	510 – 600 mm	070917	12.00 kg	070917V	17.00 kg
ABS joint tape cage 700 rough	610 – 700 mm	070918	12.50 kg	070918V	18.30 kg
ABS joint tape cage 800 rough	710 – 800 mm	070919	14.05 kg	070919V	20.70 kg
ABS joint tape cage 900 rough	810 – 900 mm	070920	14.55 kg	070920V	22.00 kg
ABS joint tape cage 1000 rough	910 – 1000 mm	070921	15.05 kg	070921V	23.35 kg

Technical details page 84

All intermediate dimensions of the rib lath width available.

Installation dimension E > 1000 mm available on request

For proper formwork results, we recommend our ABS formwork comb type spacers.

When ordering, please specify the joint tape width (190, 240 or 320 mm).

You will find the suitable joint tapes on page 34. A separate order is required.

NEW! ABS joint tape cage Deflection profile toothed

Stopend panel for retrofitting joint tapes

Joint category: toothed, according to DIN EN 1992-1-1 NA (EC2)

Bending radius 150 mm according to DIN 18197

Art.Gr.
232

Type S = Standard braced

Installation dimension E

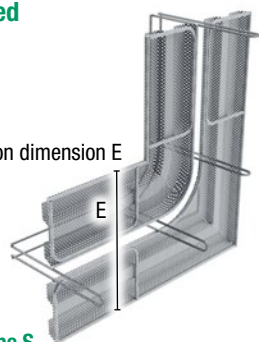

ABS joint tape cage
Deflection profile toothed – **Type S**

Type V = Reinforced version

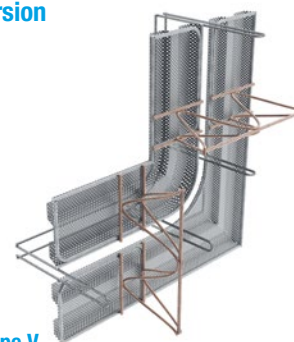

ABS joint tape cage
Deflection profile toothed – **Type V**

Description	Installation dimension E = Rib lath width	Type S = Standard braced		Type V = Reinforced version	
		Art. no.	Weight per pc.	Art. no.	Weight per pc.
ABS joint tape cage ULP 160 toothed	Up to 160 mm	070963	5.28 kg	–	–
ABS joint tape cage ULP 200 toothed	170 – 200 mm	070964	5.35 kg	070964V	6.18 kg
ABS joint tape cage ULP 250 toothed	210 – 250 mm	070965	5.44 kg	070965V	6.48 kg
ABS joint tape cage ULP 300 toothed	260 – 300 mm	070966	5.53 kg	070966V	6.78 kg
ABS joint tape cage ULP 400 toothed	310 – 400 mm	070967	5.72 kg	070967V	7.38 kg
ABS joint tape cage ULP 500 toothed	410 – 500 mm	070968	5.90 kg	070968V	7.97 kg
ABS joint tape cage ULP 600 toothed	510 – 600 mm	070969	6.08 kg	070969V	8.57 kg
ABS joint tape cage ULP 700 toothed	610 – 700 mm	070970	6.26 kg	070970V	9.17 kg
ABS joint tape cage ULP 800 toothed	710 – 800 mm	070971	6.44 kg	070971V	9.76 kg
ABS joint tape cage ULP 900 toothed	810 – 900 mm	070972	6.63 kg	070972V	10.36 kg
ABS joint tape cage ULP 1000 toothed	910 – 1000 mm	070973	6.81 kg	070973V	10.60 kg

Technical details page 85

All intermediate dimensions of the rib lath width available.

Installation dimension E > 1000 mm available on request

For proper formwork results, we recommend our ABS formwork comb type spacers.

When ordering, please specify the joint tape width (190, 240 or 320 mm).

You will find the suitable joint tapes on page 34. A separate order is required.

NEW! ABS joint tape cage
Deflection profile rough

Stopend panel for retrofitting joint tapes

Joint category: rough, according to DIN EN 1992-1-1 NA (EC2)

Bending radius 150 mm according to DIN 18197

Art.Gr.
232

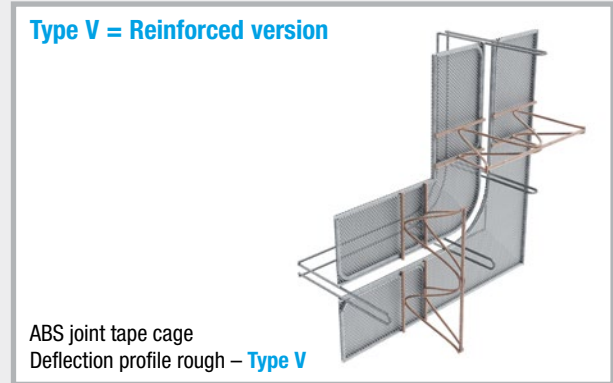
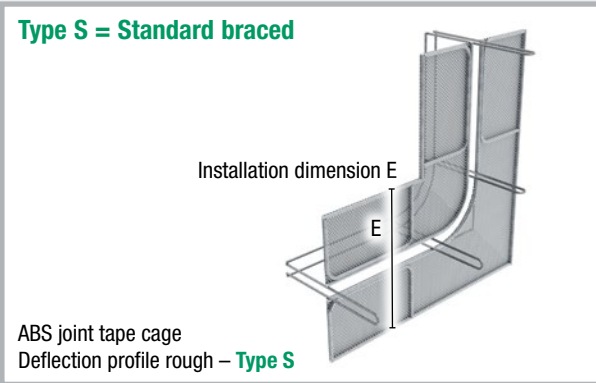

Description	Installation dimension E = Rib lath width	Type S = Standard braced		Type V = Reinforced version	
		Art. no.	Weight per pc.	Art. no.	Weight per pc.
ABS joint tape cage ULP 130 rough	Up to 130 mm	070950	5.18 kg	–	–
ABS joint tape cage ULP 160 rough	140-160 mm	070951	5.22 kg	–	–
ABS joint tape cage ULP 200 rough	170 – 200 mm	070952	5.28 kg	070952V	6.11 kg
ABS joint tape cage ULP 250 rough	210 – 250 mm	070953	5.35 kg	070953V	6.39 kg
ABS joint tape cage ULP 300 rough	260 – 300 mm	070954	5.42 kg	070954V	6.67 kg
ABS joint tape cage ULP 400 rough	310 – 400 mm	070955	5.57 kg	070955V	7.23 kg
ABS joint tape cage ULP 500 rough	410 – 500 mm	070956	5.72 kg	070956V	7.79 kg
ABS joint tape cage ULP 600 rough	510 – 600 mm	070957	5.86 kg	070957V	8.35 kg
ABS joint tape cage ULP 700 rough	610 – 700 mm	070958	6.01 kg	070958V	8.91 kg
ABS joint tape cage ULP 800 rough	710 – 800 mm	070959	6.15 kg	070959V	9.47 kg
ABS joint tape cage ULP 900 rough	810 – 900 mm	070960	6.30 kg	070960V	10.03 kg
ABS joint tape cage ULP 1000 rough	910 – 1000 mm	070961	6.44 kg	070961V	10.59 kg

Technical details page 85

All intermediate dimensions of the rib lath width available.
Installation dimension E > 1000 mm available on request

For proper formwork results, we recommend our ABS formwork comb type spacers.

When ordering, please specify the joint tape width (190, 240 or 320 mm).
You will find the suitable joint tapes on page 34. A separate order is required.

ABS expansion joint elements

Thickness of the expansion joint insert (rigid foam): 20 mm

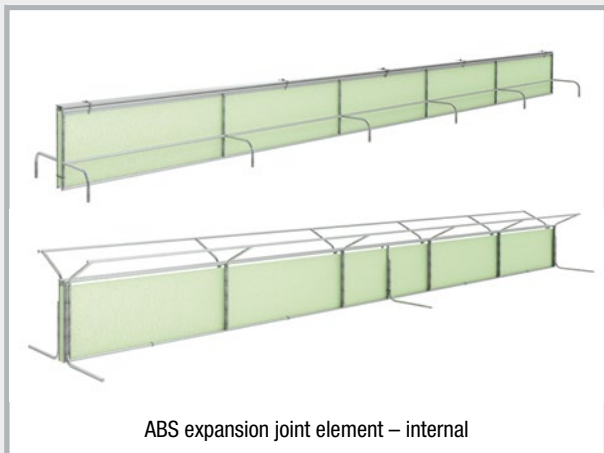

ABS expansion joint element – internal

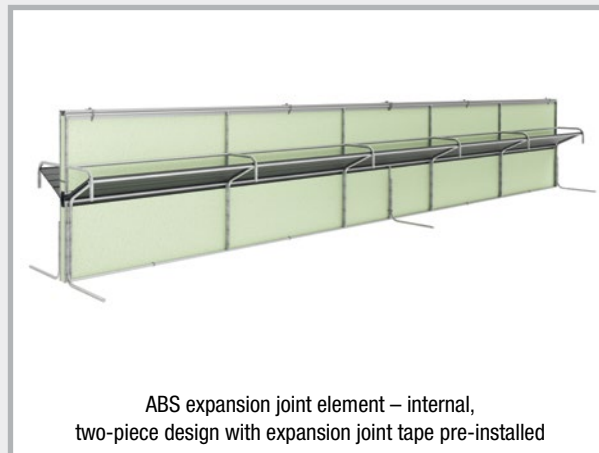

ABS expansion joint element – internal, two-piece design with expansion joint tape pre-installed

Expansion joint elements for mounting an internal expansion joint tape 240 to 320 mm.

NEW! ABS expansion joint element – internal

Art.Gr. 235

Description	Component thickness	Length	Art. no.	Weight per kg
ABS expansion joint element internal, 180-200	180-200 mm	2.4 m	070940	14.55 kg
ABS expansion joint element internal, 210-300	210-300 mm	2.4 m	070941	14.75 kg
ABS expansion joint element internal, 310-400	310-400 mm	2.4 m	070942	15.80 kg
ABS expansion joint element internal, 410-500	410-500 mm	2.4 m	070943	15.95 kg

Component thickness > 500 mm available on request

Product description

The two-piece element is designed for use of internal expansion joint tapes with a joint tape width of 240 to 320 mm and 20 mm expansion core. The joint tapes are not included in the scope of delivery.

The base part formed with fixing feet, combines a self-standing rigid foam expansion joint insert with a 15° angled mounting cage for the expansion joint tape.

The head part which overlaps into the base part generates a straight guide for the expansion joint insert over the complete thickness of the constructional elements.

The expansion core of the joint tape is secured in the middle of the expansion joint insert.

The total height (base part + joint tape expansion core + head part) must be matched to the planned thickness of the constructional elements.

You will find the suitable expansion joint tapes on page 34.

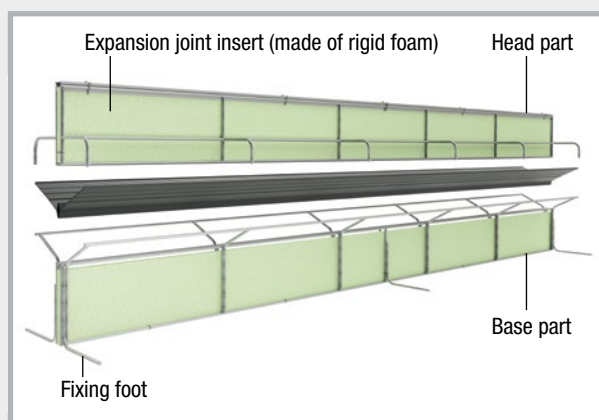

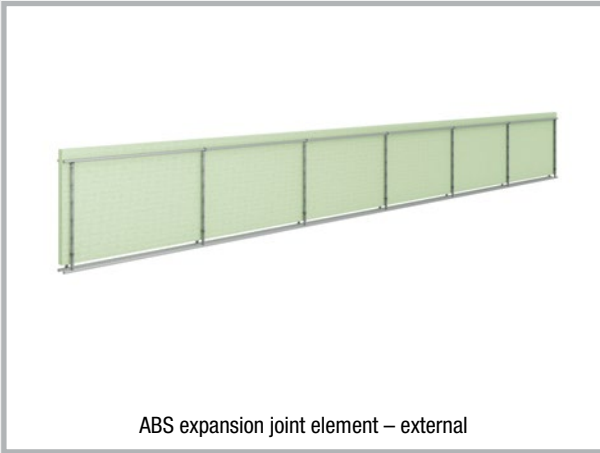

ABS expansion joint element – external

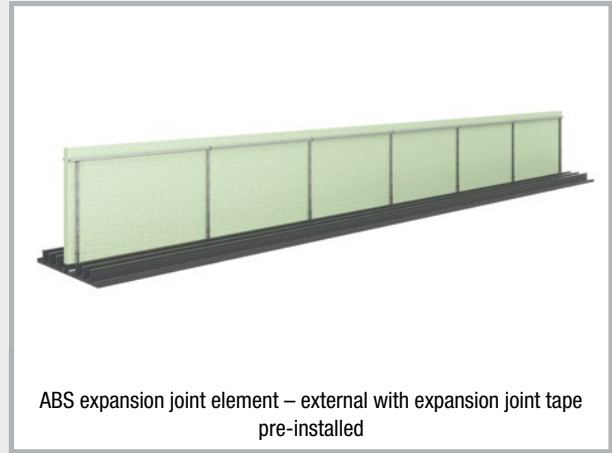

ABS expansion joint element – external with expansion joint tape pre-installed

Expansion joint elements for external expansion joint tapes and joint tapes for capping joints (specify additionally when ordering).

NEW! ABS expansion joint insert – external

Art.Gr. 235

Description	Component thickness	Length	Art. no.	Weight per kg
ABS expansion joint element external, 180-200	180-200 mm	2.4 m	070944	4.90 kg
ABS expansion joint element external, 210-300	210-300 mm	2.4 m	070945	5.45 kg
ABS expansion joint element external, 310-400	310-400 mm	2.4 m	070946	5.60 kg
ABS expansion joint element external, 410-500	410-500 mm	2.4 m	070947	6.50 kg

Component thickness > 500 mm available on request

Product description

The external ABS expansion joint element is designed for external expansion joint tapes and joint tapes for capping joints with an expansion core of 20 mm. The joint tapes are not included in the scope of delivery.

It comprises a rigid foam expansion joint insert with a thickness of 20 mm, combined with a stabilisation cage arranged on both sides. The stabilisation cage has a projection in the base area which is matched to the height of the expansion core and overlaps with the expansion core. In the head area, the expansion joint insert projects around the concrete cover.

When using joint tapes for capping joints, the stabilisation cage is set back by the overlap length of the joint tapes for capping joints.

You will find the suitable expansion joint tapes on page 34.

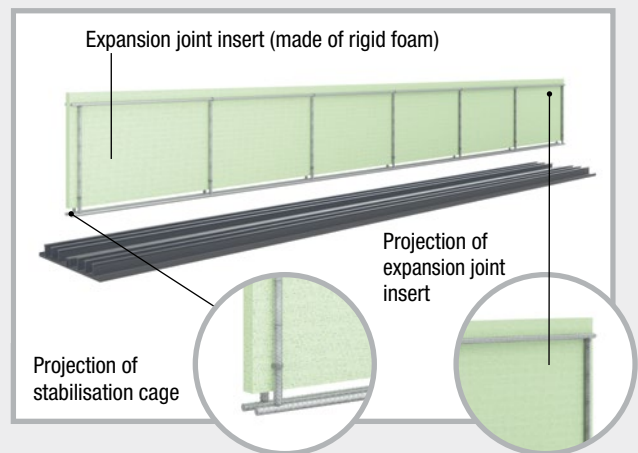

VB joint sheet metal high-pressure metal sheets



Product description

- VB joint sheet metal consists of a galvanised carrier sheet which is coated with a reactive, bitumen-free polymer coating. The coating forms a watertight bond with the fresh concrete.
- High pressure watertightness with low embedment depth
- Extensive tests (abP, ETA, application tests)
- Extensive accessories for crack-inducing joints and stopend panels

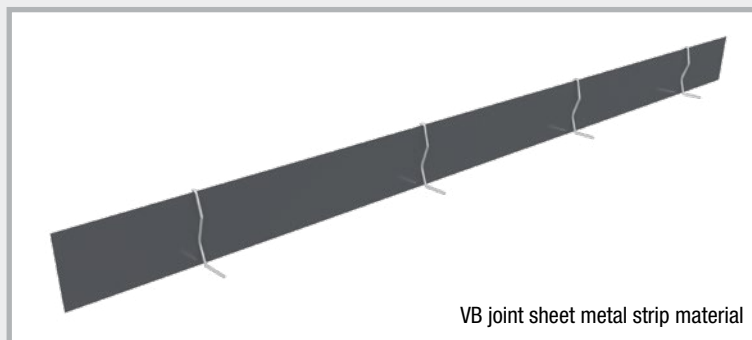

VB joint sheet metal strip material

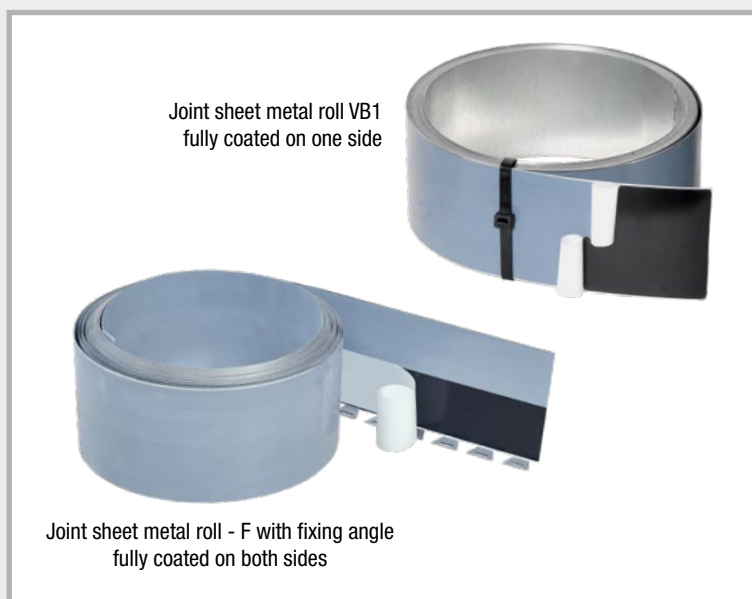

Description	Height	Length	Water pressure acc. to application test	Water pressure according to General Building Supervisory Test Certificate (abP)	Embedment depth Floor slab
Strips	80 mm	2.4 m	6 bar (60 m water column)	1 bar (10 m water column)	≥ 30 mm ≤ ½ sheet height
	160 mm	2.0 m / 2.4 m	8 bar (80 m water column)	2 bar (20 m water column)	
Rolls	120 mm	20 m	6 bar (60 m water column)	1.6 bar (16 m water column)	≥ 30 mm ≤ ½ sheet height
	160 mm	20 m	8 bar (80 m water column)	2.0 bar (20 m water column)	
	240 mm	20 m	8 bar (80 m water column)	2.0 bar (20 m water column)	
Rolls with fixing angle	160 mm	20 m	8 bar (80 m water column)	2.0 bar (20 m water column)	≥ 30 mm ≤ ½ sheet height

Technical data and detailed installation instructions can be found at

www.mastertec.eu

Installation instructions

VB joint sheet metal is available as strips or rolls with a special coating on one or both sides.

1. When installing sheet metal with coating on one side, the coating must face the water side.
2. The coating is protected against dirt by a protective film. The protective film must be removed as late as possible, but definitely before concreting.
3. The protective film is separated halfway up the sheet. When concreting the floor slab, the upper half of the protective film remains on the coating and protects it from becoming contaminated during and after concreting. The upper half is removed as late as possible before the wall is concreted (see Fig. 1).
4. Corner formations can be produced on site without any problems (see Fig. 2).
5. In the joint area, the protective film is folded back, the sheet is overlapped over a length of 6 cm, bonded over the entire surface and secured by means of system-specific fixing clips (see Fig. 3).
6. The embedment depth in the first concreting section must not be less than 30 mm and must not exceed half the sheet height.
- 7a. The position on the upper reinforcement layer is secured by means of the system-specific omega brackets (see Fig. 4).
- 7b. In the case of the **joint sheet metal roll F**, the position is secured by tying the fixing angle to the upper layer of reinforcement using tie wire (see Fig. 5).
8. The joint sheet metal must form a self-contained system that covers all construction and controlled crack joints.

Extensive system accessories available

Crack-inducing profiles pages 30 – 31

Sto pend panels pages 38 – 61

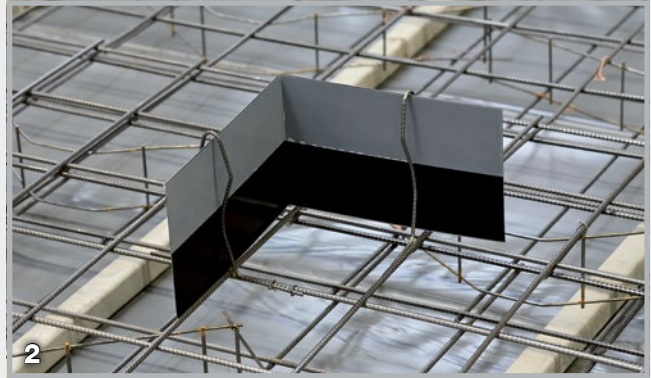

MASTER joint sheet metal



Product description

- MASTER joint sheet metal is made of galvanised sheet steel which is fully coated on both sides with a special coating. The coating forms a water-tight bond with the fresh concrete.
- Element length 2500 mm
- General Building Supervisory Test

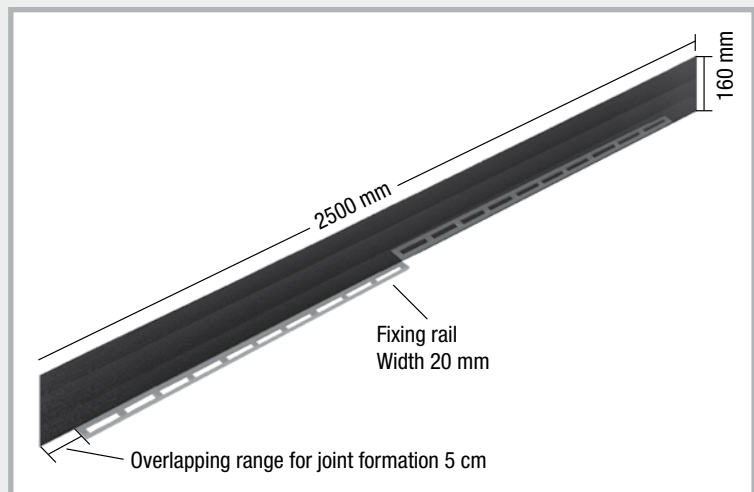

Installation instructions

1. The coating is protected against dirt by a protective film. The protective film must be removed as late as possible, but definitely before concreting.
2. The protective film is separated halfway up the sheet. When concreting the floor slab, the upper half of the protective film remains on the coating and protects it from becoming contaminated during and after concreting. The upper half is removed as late as possible before the wall is concreted (see Fig. 1).
3. In the joint area, the protective film is folded back, the sheets are overlapped over a length of 6 cm, bonded over the entire surface and secured by means of system-specific fixing clips (see Fig. 2).
4. The embedment depth in the first concreting section must not be less than 30 mm and must not exceed half the sheet height.
5. Corner formations and other geometries can be produced on site without any problems (see Fig. 3+ 4).
6. The position is secured on the upper layer of reinforcement by tying the fixing angle to the upper layer of reinforcement.
7. The joint sheet metal must form a self-contained system that covers all construction and controlled crack joints.

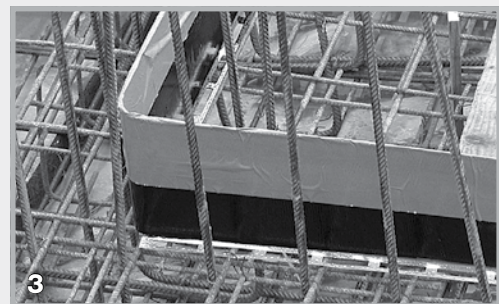

Joint sheet metal MB Overlap

Mineral-coated joint sheet metal for waterproofing of construction joints



Description

Strips with full mineral coating on both sides, 160 mm high. The metal waterproofing profiles are supplied with 55 fixing clips. You will find suitable omega brackets (art. no. 070415) on page 32. They must be ordered separately.

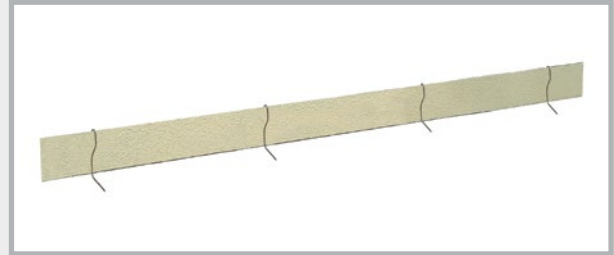

Installation instructions

1. The mineral coating must be protected from dirt.
2. The sheet metal can be cut to length on site without any problems.
3. Two sheets are joined by overlapping. The overlap length must be at least 20 cm and must be additionally secured with a fixing clip (see Fig. 1).
4. The embedment depth in the first concreting section must not be less than 30 mm and must not exceed half the sheet height.
5. Corner formations can be produced on site without any problems (see Fig. 2).
6. The position on the upper reinforcement layer is secured by means of the system-specific omega brackets.
7. The joint sheet metal must form a self-contained, gap-free system (see Fig. 3).

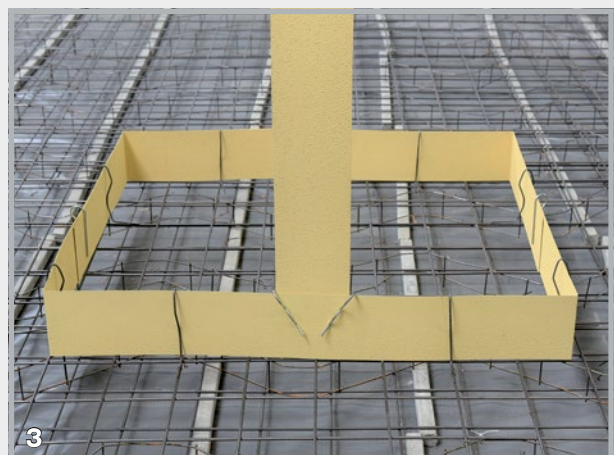
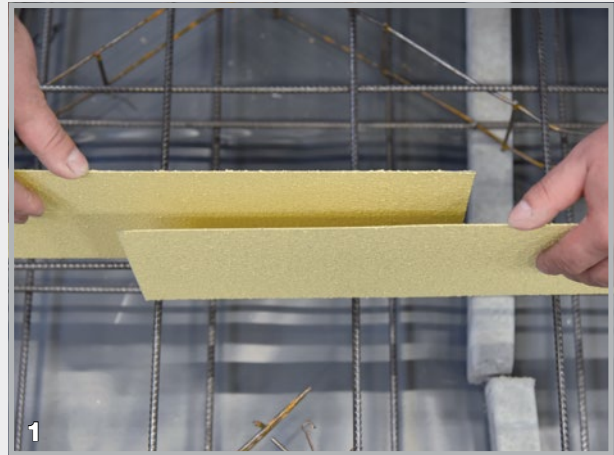

Technical data and detailed installation instructions can be found at www.mastertec.eu

AKTIV joint sheet metal



Bentonite-coated joint sheet metal for waterproofing of construction joints

Description

Joint sheet metal, fully coated on one side with bentonite. Delivered complete with installation accessories.



Installation instructions

1. The bentonite coating must face the water side.
2. The bentonite coating must be protected from dirt and moisture.
3. The sheet metal can be cut to length on site without any problems (see Fig. 1).
4. Two elements are joined by means of butyl adhesive tape. Strips of this tape are already mounted at the start and end of the roll. When cutting to size, the supplied tape must be bonded to the bentonite coating at the cutting edge. Press the adhesive surface firmly together and secure with a fixing clip (see Fig. 2 + 3).
5. The embedment depth in the first concreting section must not be less than 35 mm and must not exceed half the sheet height.
6. Corner formations can be produced on site without any problems (see Fig. 4).
7. The position on the upper reinforcement layer is secured by means of the system-specific omega brackets.
8. The joint sheet metal must form a self-contained, gap-free system.

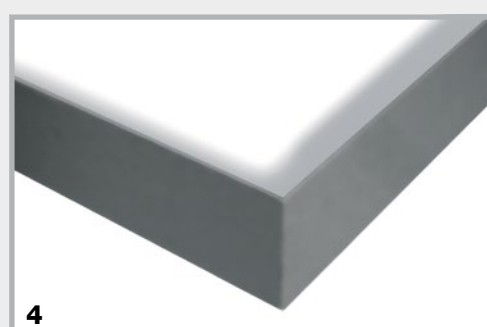
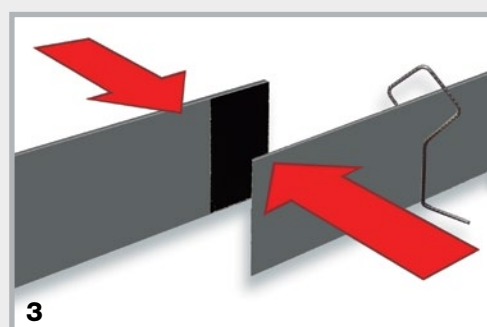
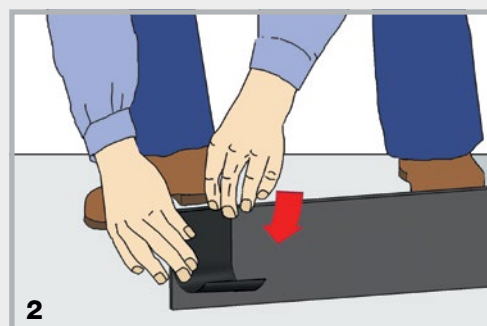

Technical data and detailed installation instructions can be found at www.mastertec.eu

MASTER-MultiFlex (MMF 140)

The active joint tape with General Building Supervisory Test Certificate for waterproofing of construction joints in concrete. MMF 140 is a PVC joint tape with an additional swelling profile on the bottom.



MMF 140 product description

- Material:** Soft PVC – free from cadmium, chromium and lead
MMF 140 does not contain any substances of very high concern (SVHCs) according to Annex XIV of the REACH Regulation.
MMF 140 thus complies with European standards.
- Swelling profile:** Active TPE
- Height:** 140 mm
- Thickness:** approx. 6 mm
- Profile:** Corrugated
- Safety:** with marking strips for embedment depth
- Elongation at break:** High
- Tensile strength:** High
- Workability:** -10°C to +60°C
- Joinability:** Welding or with our MASTER-Connect “active”

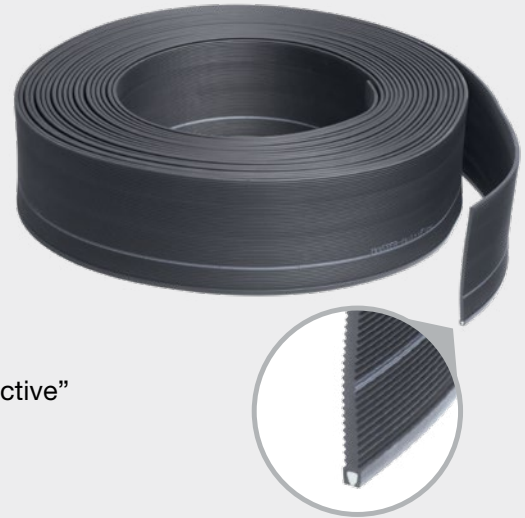

Function of MMF 140

- 1.** The figure shows the bottom of the joint tape with the swelling profile still not activated.
- 2.** The pressure resistance of MMF 140 has already been proven from an embedment depth of 3 cm. In the image, you see the joint tape with the activated swelling profile.
- 3.** Here, you see the function of the swelling profile. It expands downwards and compresses the joint. For further security the two flanks are pushed outwards, also stopping the flow of water.

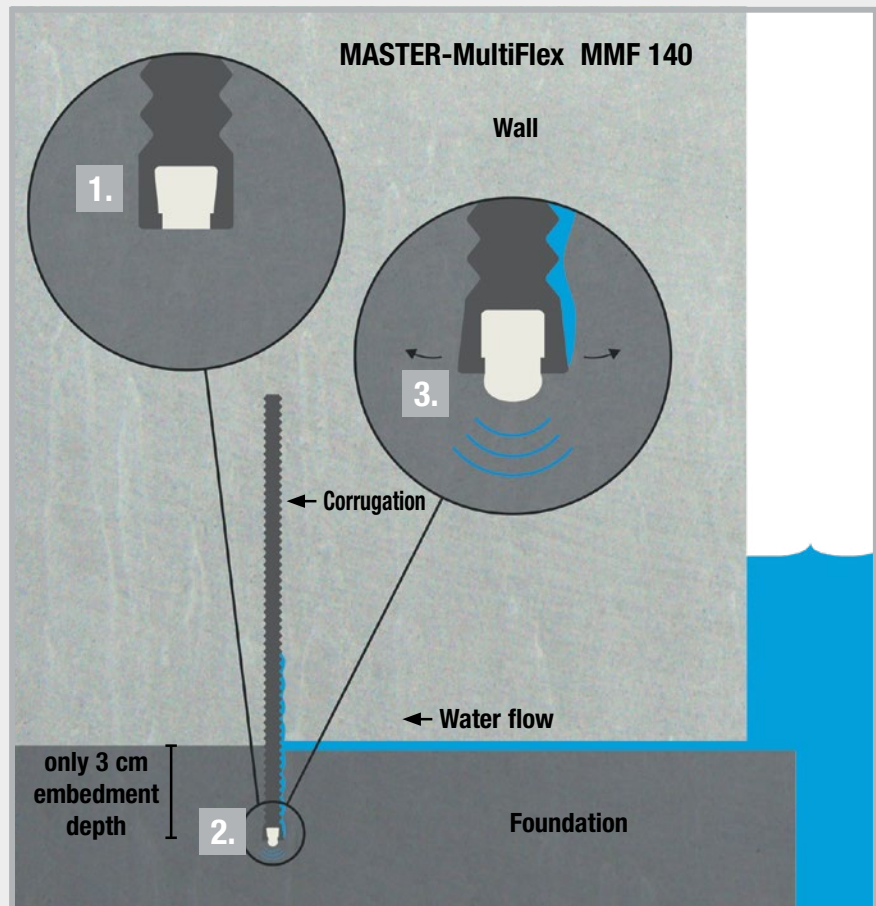

Resistance

MMF 140 has a good to very good resistance to a number of chemicals and media.

- Diluted acids and alkalis
- Salt water
- Alkalinity of concrete
- Urea
- Methane gas
- Biogas
- Very good ageing resistance
- Very good long-term performance

Cutting and installing MMF 140



The non-sagging joint tape can be cut to length easily with a cutter.

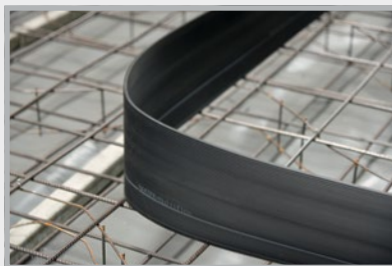

Non-sag but flexible.

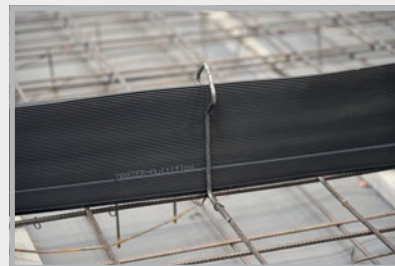

Fastened using the system-specific MMF 140 omega brackets. These have to be ordered separately.

Bonding options



Welding:

Time required at the construction site: approx. 30-40 min.

Welded, overlapped join.

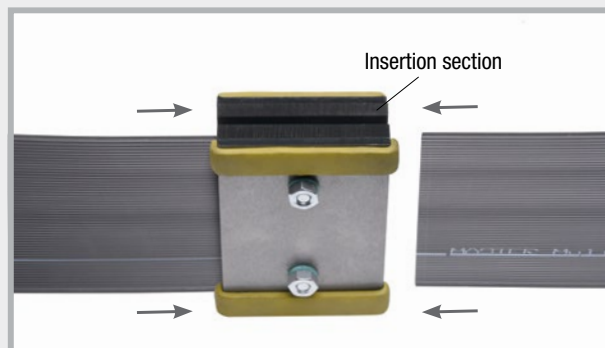

Screwed connection:

Time required at the construction site: approx. 10-15 min.

The MMF 140 joint tape is inserted into the MASTER-Connect on the left and right, and the screws are tightened to approximately 8 Nm.

VB joint sheet metal JGS (slurry/liquid manure/silage effluent)



National technical approval (abZ):
Z-74.101-209



The Ordinance on Facilities Handling Substances that are Hazardous to Water (AwSV) has defined the requirements for agricultural installations nationwide since 1 August 2017. The aim is to protect water from substances hazardous to water from agricultural structures such as silos, slurry tanks or biogas facilities.

Special requirements are placed on the construction joint sealants here. These must have verification of fitness for use in the form of a national technical approval (abZ). By extensive resistance and functional tests the VB joint sheet metal JGS has received this verification of fitness for use.

Product description

- VB joint sheet metal JGS consists of a galvanised carrier sheet with a highly resistant special coating. The coating forms a watertight bond with the fresh concrete.
- The coating is resistant to media that affect components in agricultural buildings and biogas facilities.
- National technical approval (abZ) granted by DIBt
- Low embedment depth of 35 mm



Description	Height	Length	Tank height	Embedment depth Floor slab
Strips	160 mm	2.4 m	≤ 10 m	≥ 35 mm ≤ ½ sheet height
Rolls	160 mm	20 m	≤ 10 m	≥ 35 mm ≤ ½ sheet height
Rolls with fixing angle	160 mm	20 m	≤ 10 m	≥ 35 mm ≤ ½ sheet height
Stopend panels	All versions of the stopend panels ABS (page 40/41) are also available in JGS (slurry/liquid manure/silage effluent) design.			

Installation instructions

The installation is identical to the VB joint sheet metal (page 65).
However, the embedment depth must be 35 mm into the first concreting section.

Accessories

The verification of fitness for use in the form of the national technical approval (abZ) applies not only to waterproofing products for construction joints but also to pipe penetrations. Here, RONDO Protect offers a waterproofing solution for all common pipe types. You will find an overview on page 131 in our complete catalogue.



Technical data and installation instructions can be found at www.mastertec.eu

Crack-inducing profiles

Crack-inducing profile SRF 125 Multi



The SRF 125 Multi profile consists of a coated joint sheet metal element with perforated support rails attached to both sides and additional retaining plates. Depending on the requirements, the profile is fastened via the support rails or the perforated foldable retaining plates.

Type SRF 125 Multi in-situ concrete

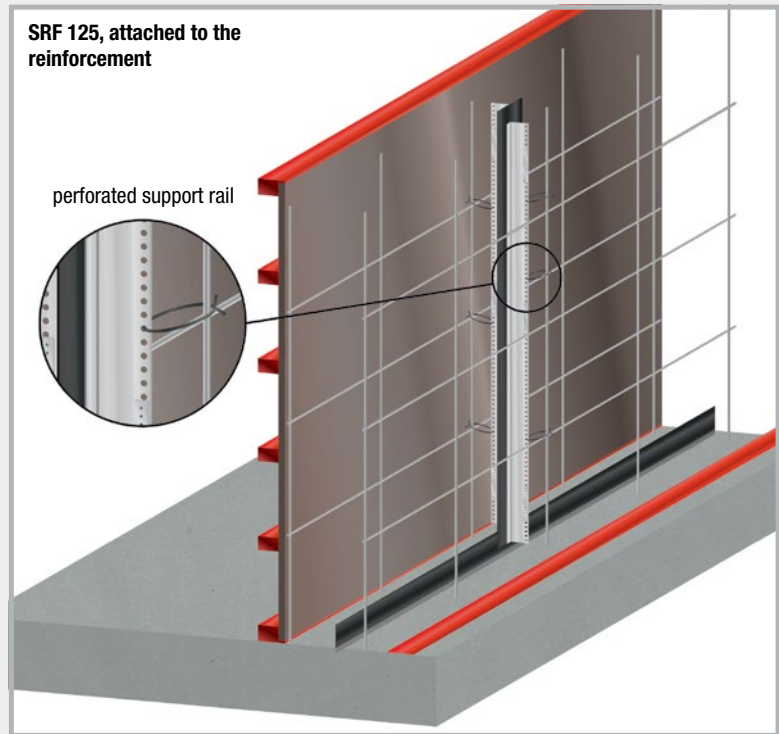
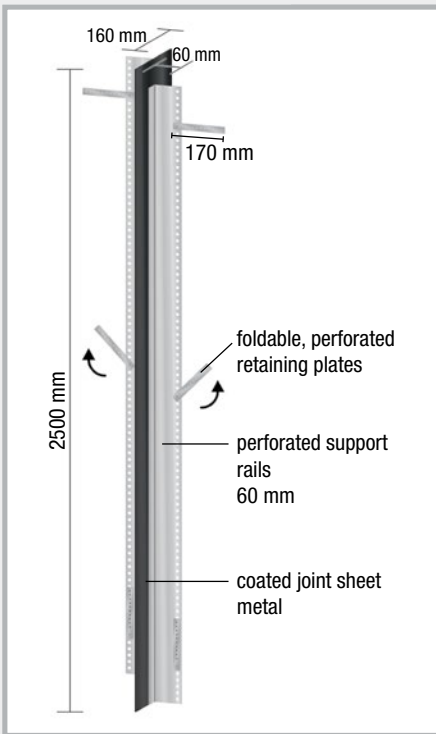

Type SRF 125 Multi cavity wall

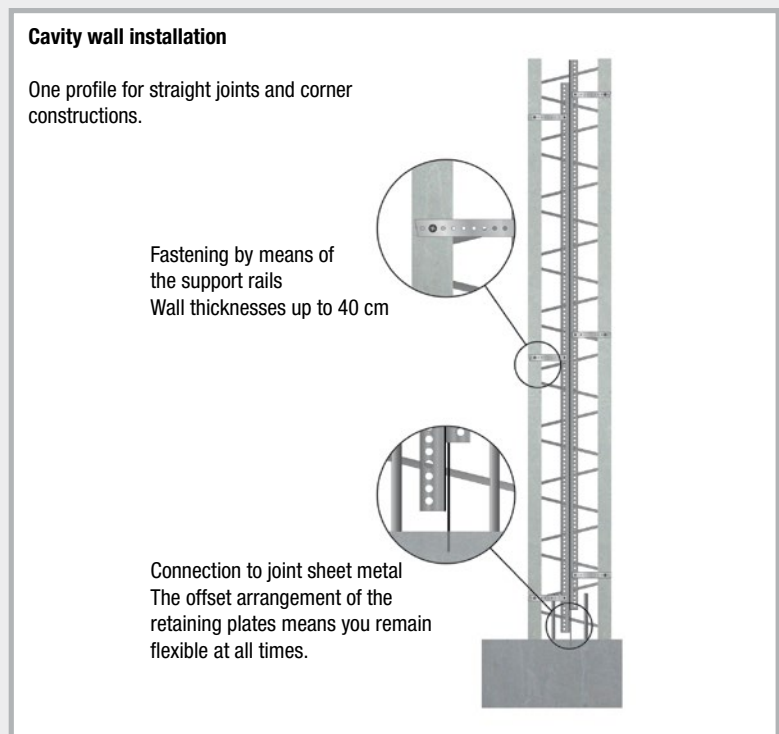
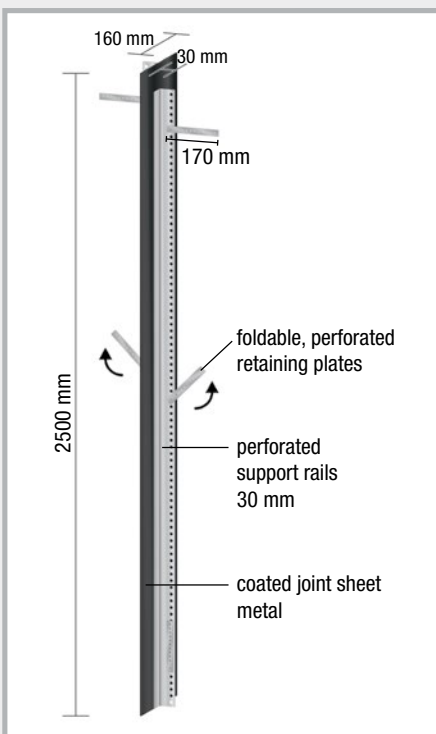

Crack-inducing profile SRF 125 Multi cavity wall

Corner installation

The cavity wall type crack-inducing profile SRF 125 Multi can also be used without any problems in the corner butt joint of cavity wall elements.

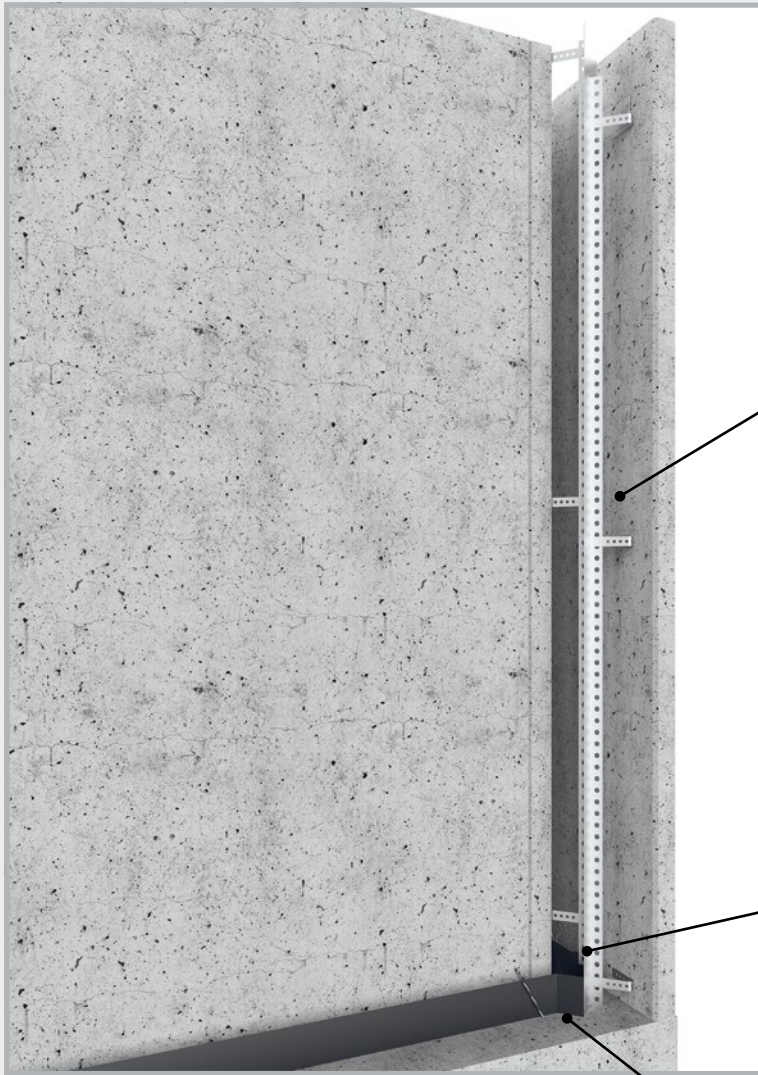

The profile is inserted vertically in the middle of the course of the crack between the external and internal formwork of the cavity wall element.

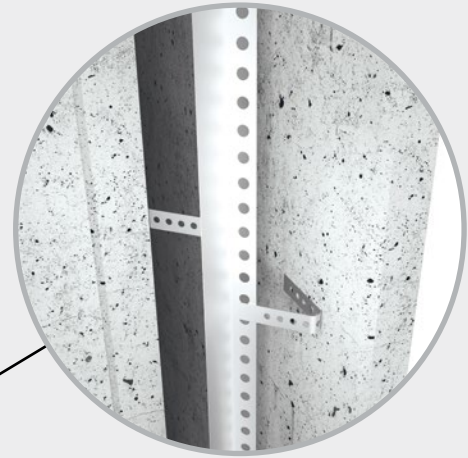

The retaining plates are angled in accordance with the course of the internal formwork and anchored in the concrete with nail plugs.

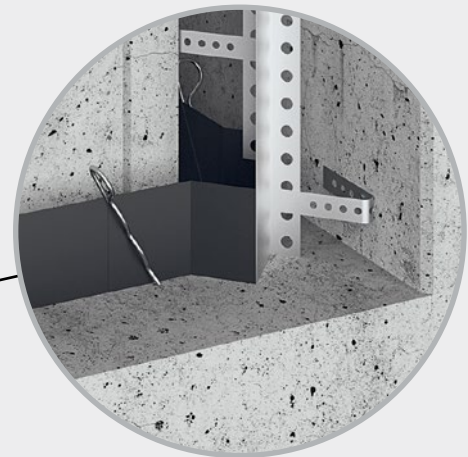

At the bottom, the joint sheet metal is adhered with the floor-wall joint sheet metal with an overlap, and is secured with fixing clips.

The corner area of the course of the floor-wall joint sheet metal **must** be implemented so that the crack-inducing profile can be introduced vertically to the course of the crack. For the corner construction, we recommend installing VB joint sheet metal corner element FB (art. no. 070224)

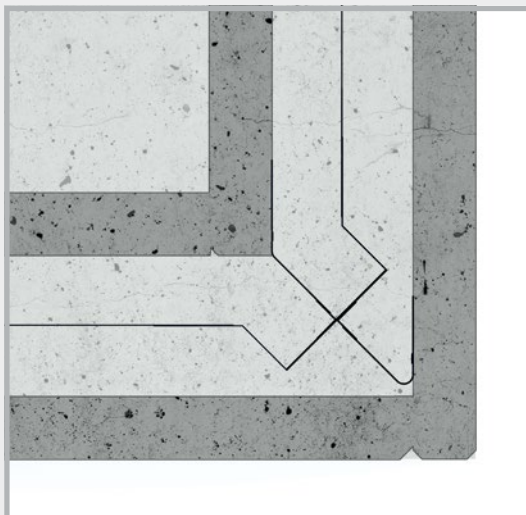
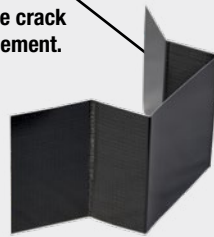

Corner installation up to wall thickness of 300 mm possible.



MASTER joint sheet metal SFG adjustable

(prefabricated crack-inducing element, straight) for straight butt joints

The profile consists of a fully coated joint sheet metal, which forms a watertight bond with the fresh concrete, and adjustable brackets.

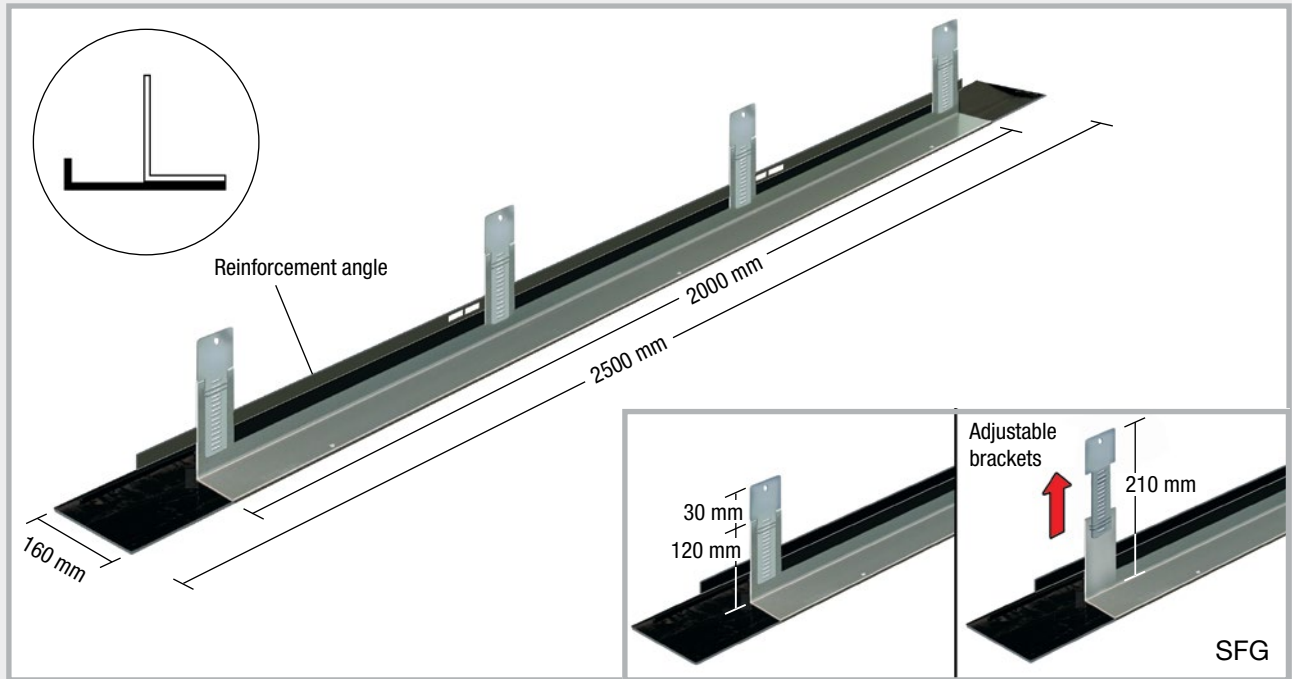

Installation

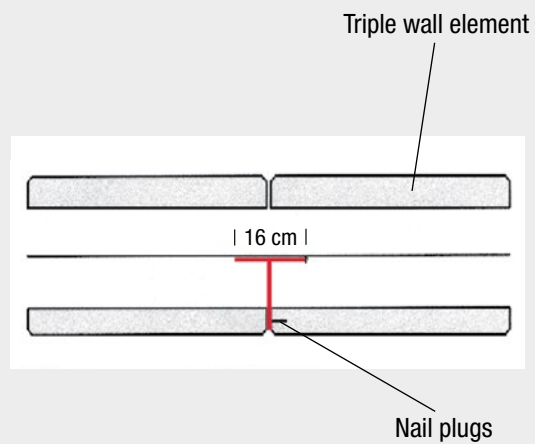
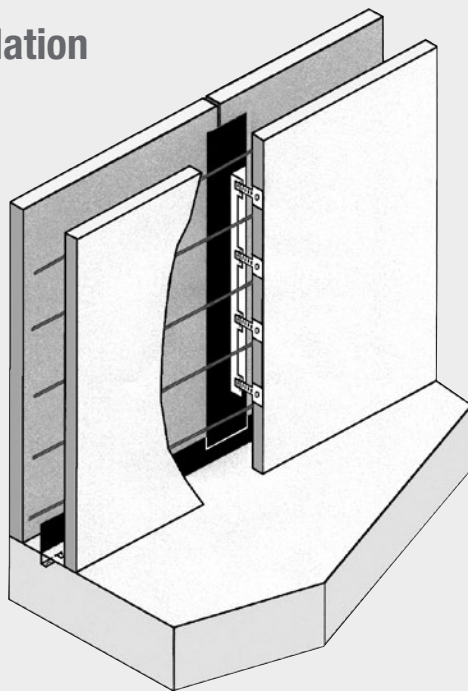

The elements supplied are completely prefabricated and are fastened to the internal formwork of the cavity wall elements using the supplied nail plugs. The lower part of the elements is bonded to the waterproofing profile in the foundation area.

MASTER joint sheet metal SFE adjustable

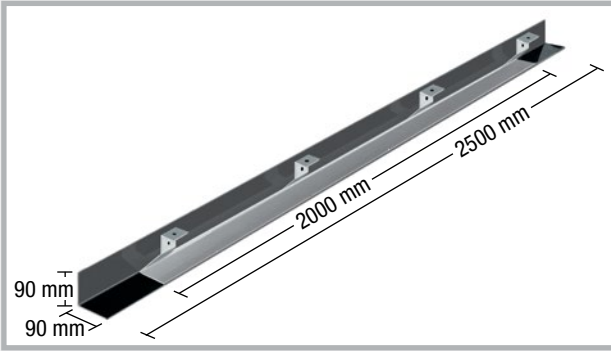

SFE profile

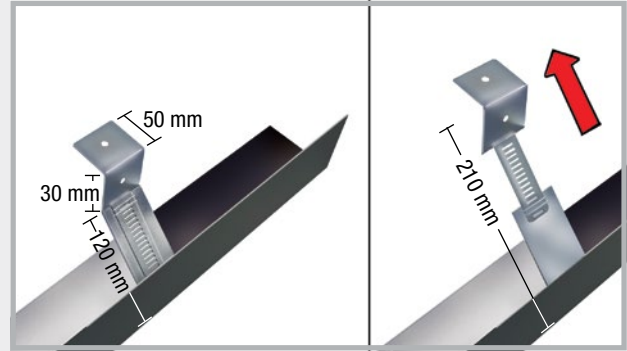

Adjustable brackets

MASTER joint sheet metal FE adjustable

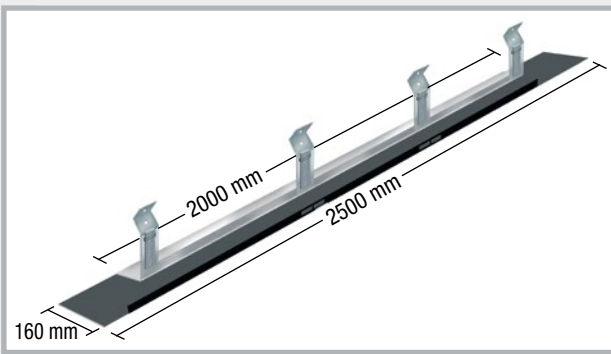

FE profile

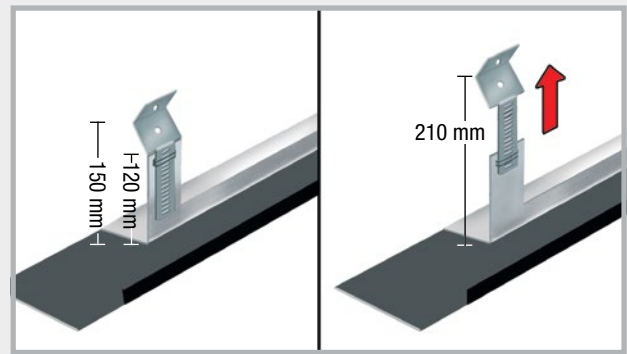

Adjustable brackets

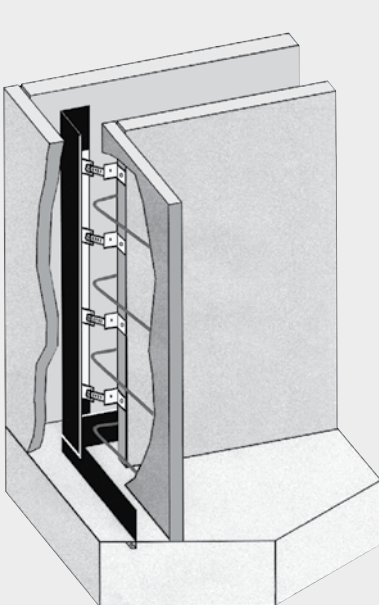

The adjustable brackets always enable contact with the waterproofing elements in the foundation.

Installation of SFE

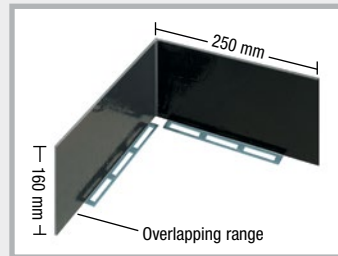

MASTER joint sheet metal angle 90° for connection of SFE profile

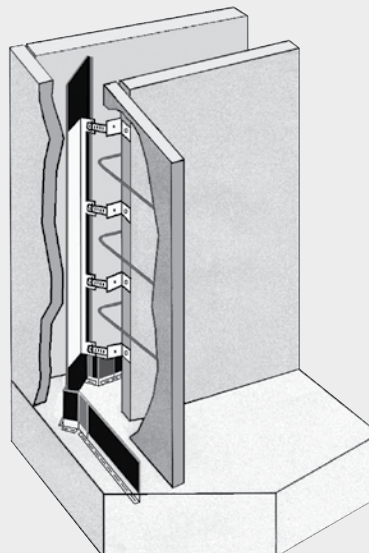

Installation of FE

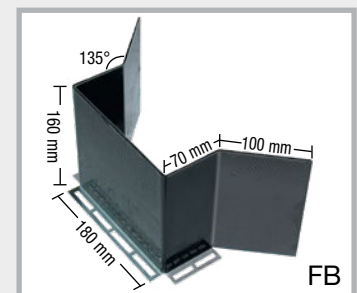

MASTER joint sheet metal corner element FB for connection of FE profile

Formwork systems

ABS stopend panels rough/toothed

for construction joints exposed to pressurised water

The stopend panels ABS rough/toothed consist of a joint sheet metal with polymer coating on both sides in the edge area, which represents the horizontal sealing level when installed in the floor slab and the vertical sealing level when installed in the wall.

Perpendicular to the joint sheet metal, rib lath strips form the formwork level.

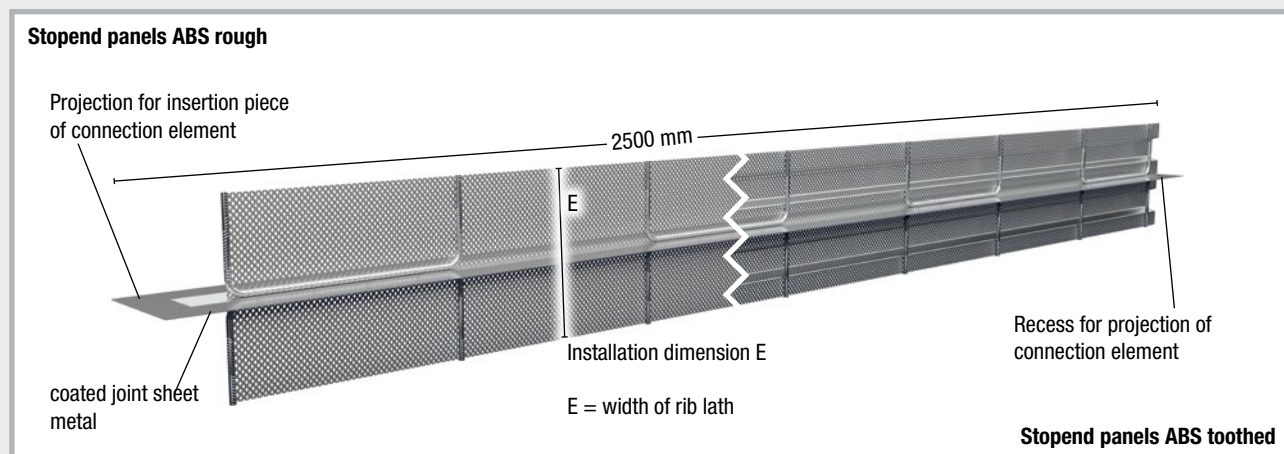

Waterproofing

- All-round polymer coating on both sides in the edge area
- Proof of usability: abP and ETA
- For joint opening up to 1.0 mm



European Technical Assessment (ETA):

Intended purpose: Sealing element for sealing construction joints in structures made of concrete with high water penetration resistance against pressurised and non-pressurised water.



General Building Supervisory Test Certificate (abP):

2 bar water pressure (20 m water column) with joint opening up to 1.0 mm

Application test:

6 bar water pressure (60 m water column) with joint opening up to 1.0 mm



The carrier and coating material has good to very good resistance to chemicals and other media.

Shuttering

The geometry and open passage of the rib lath strips create the following construction joint surfaces after concreting:

ABS rough: rough joint according to DIN EN 1992-1-1 NA (EC2)

ABS toothed: toothed joint according to DIN EN 1992-1-1 NA (EC2)

Stopend panels ABS rough

for construction joints exposed to pressurised water

- Pressure watertight
- Rough joint according to DIN EN 1992-1-1 NA (EC2)
- Ready-to-install matched to floor slabs/wall thicknesses
- Special versions with diagonal cut, height offset, recesses or crown cut are possible (see page 47).

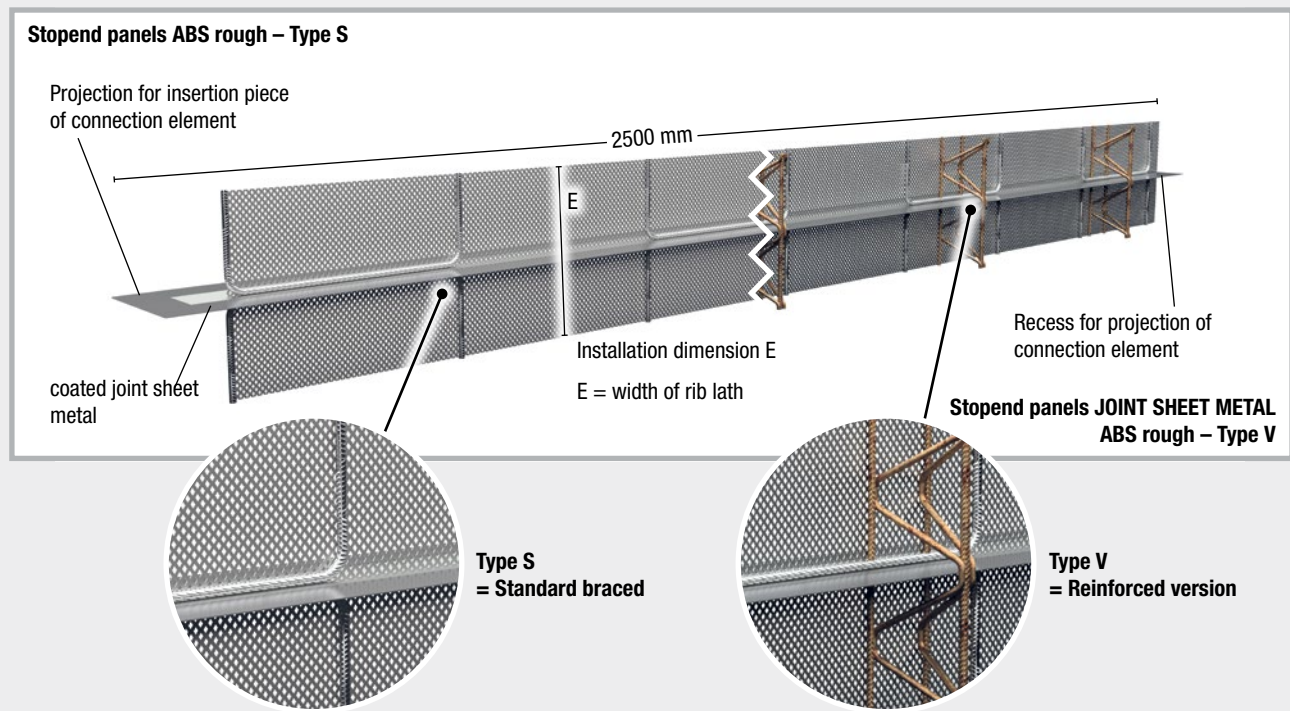

Bracing options

- Type S Standard braced = Reinforcing steel U-brackets stabilise the rib lath
- Type V Reinforced version = Increased stability due to additional lattice girders + mounting edge

Installation size

- Installation dimensions from 130 to 1000 mm available, sizes > 1000 mm on request
- Special dimensions possible on request

Installation instructions

- Place the ABS elements between the reinforcement layers and fix them with tie wire.
- Fold back the protective film of the sheet metal projection and in the area of the recess of the next element, push the projection into the recess, press the coating firmly together and secure with the supplied fixing clip.
- The elements remain in the concrete, i.e. no time-consuming formwork or stripping required.
- Remove the protective film in the concreting area before concreting.
- The back anchoring and securing the position of the elements against concrete pressure is carried out at the construction site.

Stopend panels ABS toothed

for construction joints exposed to pressurised water

- Pressure watertight
- Toothed joint according to DIN EN 1992-1-1 NA (EC2)
- Ready-to-install matched to floor slabs/wall thicknesses
- Special versions with diagonal cut, height offset, recesses or crown cut are possible (see page 47).

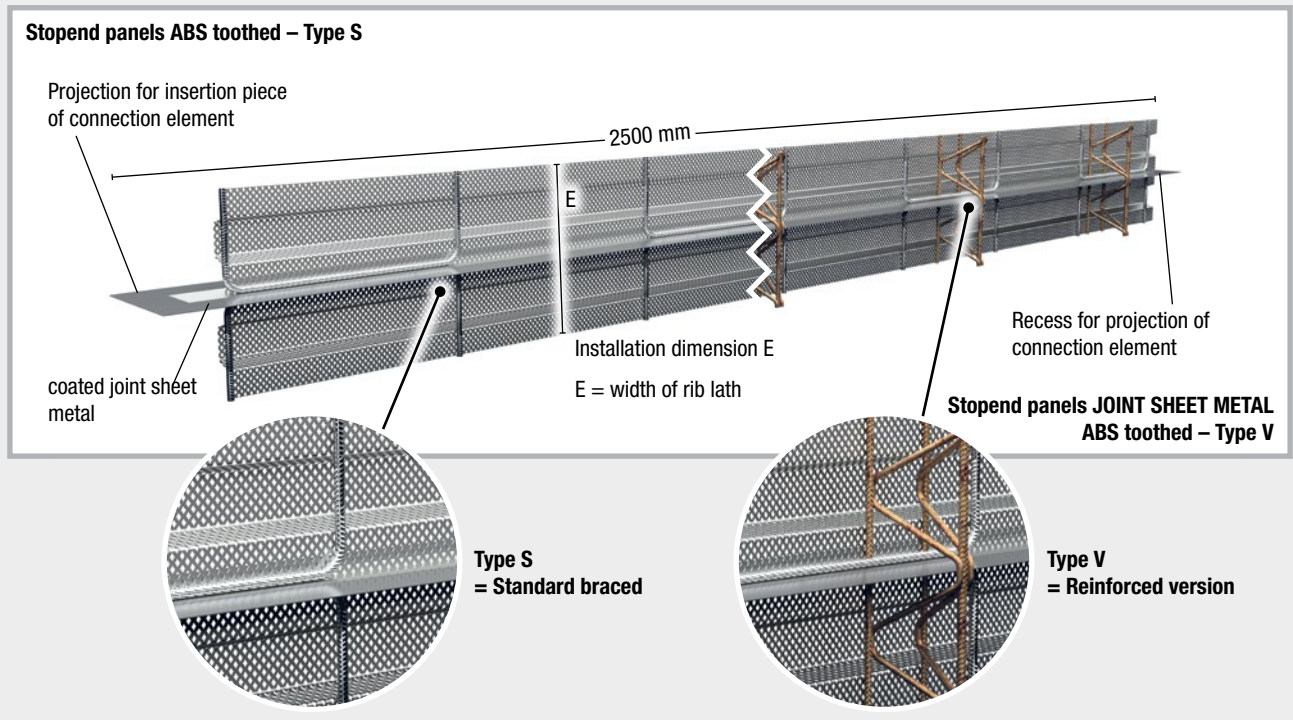

Bracing options

- Type S Standard braced = Reinforcing steel U-brackets stabilise the rib lath
- Type V Reinforced version = increased stability due to additional lattice girders + mounting edge

Installation size

- Installation dimensions from 160 to 1000 mm available, sizes > 1000 mm on request
- Special dimensions possible on request

Installation instructions

- Place the ABS elements between the reinforcement layers and fix them with tie wire.
- Fold back the protective film of the sheet metal projection and in the area of the recess of the next element, push the projection into the recess, press the coating firmly together and secure with the supplied fixing clip.
- The elements remain in the concrete, i.e. no time-consuming formwork or stripping required.
- Remove the protective film in the concreting area before concreting.
- The back anchoring and securing the position of the elements against concrete pressure is carried out at the construction site.

ABS deflection profiles rough/toothed

for changing the direction of the sealing level from horizontal to vertical

- Pressure watertight
- Rough/toothed joint according to DIN EN 1992-1-1 NA (EC2)
- Ready-to-install, matched to the thickness of the floor slab

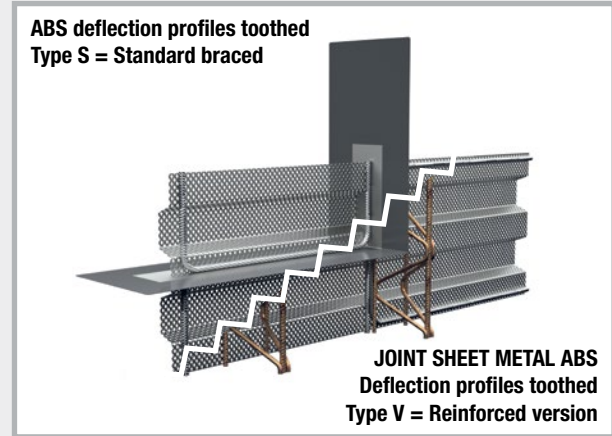
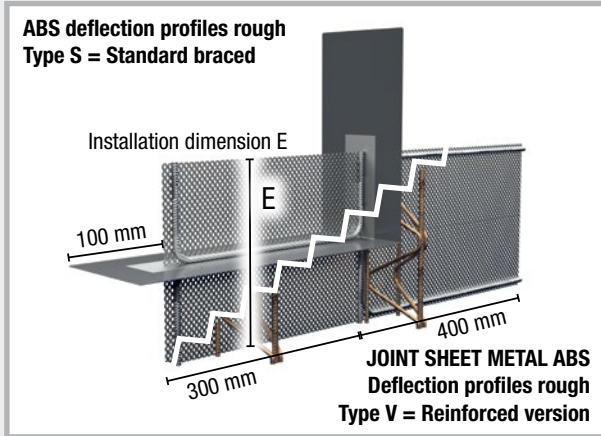

The ABS deflection profiles rough/toothed are used when switching from foundation formwork to wall formwork. Likewise, if the joint sheet metal from the foundation/wall transition is connected to the closed system of the sealing level in the area of the foundation formwork. The ABS deflection profiles rough/toothed are delivered ready-to-install and matched to the floor slab thickness. They are compatible with the stopend panels ABS rough/toothed.

ABS corner profile rough/toothed

for changing the direction of the sealing level in the floor slab

- Pressure watertight
- Rough/toothed joint according to DIN EN 1992-1-1 NA (EC2)
- Ready-to-install, matched to the thickness of the floor slab

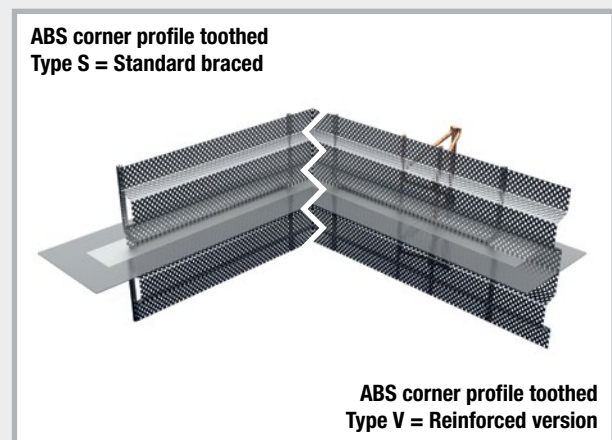
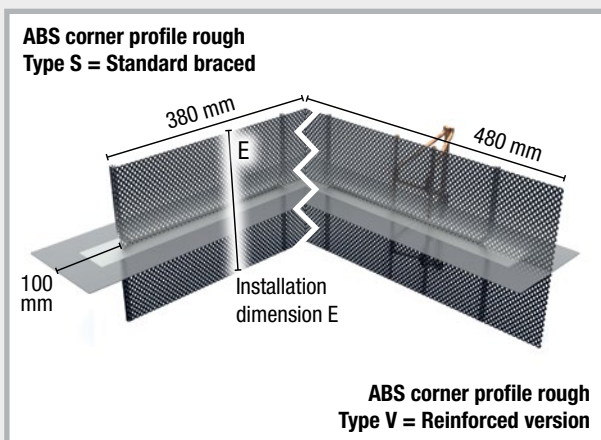

The ABS corner profile rough/toothed are used for corner formations of the floor slab formwork. The ABS corner profiles rough/toothed are delivered ready-to-install and matched to the floor slab thickness. They are compatible with the stopend panels ABS rough/toothed.

ABS T-profile rough/toothed

for T-joints of the stopend panels with retention of the sealing level in the floor slab

- Pressure watertight
- Rough/toothed joint according to DIN EN 1992-1-1 NA (EC2)
- Ready-to-install, matched to the thickness of the floor slab

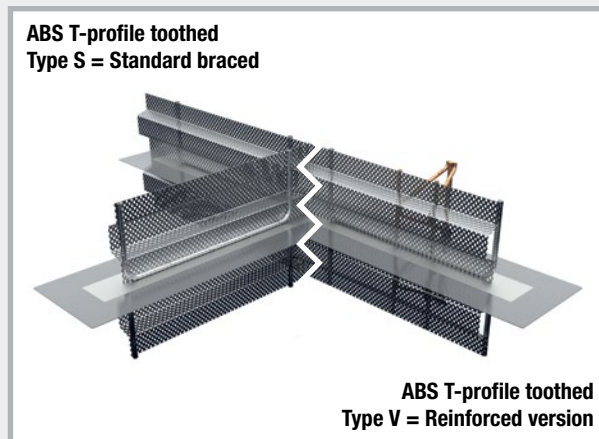
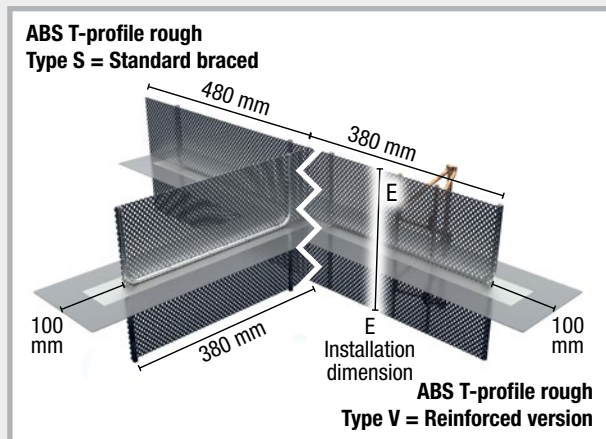

The ABS T-profile elements rough/toothed are used at one-sided joints of the floor slab formwork. The ABS T-profile elements rough/toothed are delivered ready-to-install and matched to the floor slab thickness. They are compatible with the stopend panels ABS rough/toothed.

ABS cross-profile rough/toothed

for cross joints of the stopend panels with retention of the sealing level in the floor slab

- Pressure watertight
- Rough/toothed joint according to DIN EN 1992-1-1 NA (EC2)
- Ready-to-install, matched to the thickness of the floor slab

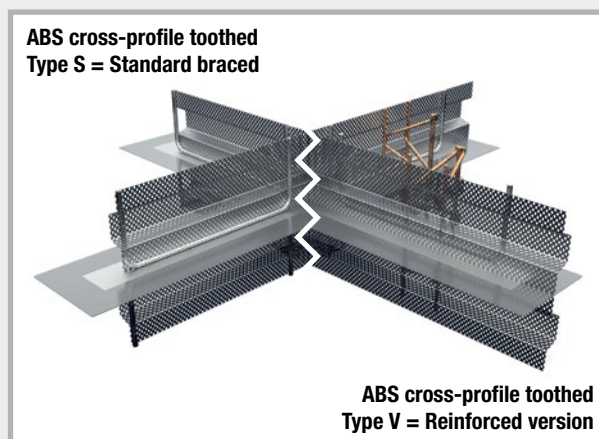
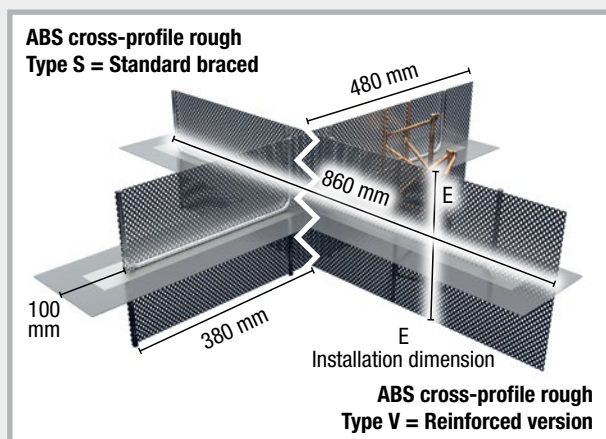

The ABS cross-profile elements rough/toothed are used at crossing points of the floor slab formwork. The ABS cross-profile elements rough/toothed are delivered ready-to-install and matched to the floor slab thickness. They are compatible with the stopend panels ABS rough/toothed.

ABS crack-inducing elements

for forming controlled crack joints with exposure to pressurised water

In order to prevent unplanned and difficult-to-control cracking in concrete components, systematically including controlled crack joints is recommended. They can be produced using systematic sectional weakening (as per the German WU directive for Water-Impermeable Concrete Buildings > 1/3 of the thickness of the constructional elements) of the concrete in conjunction with an adjustment of the reinforcement in the planned crack-inducing joint area. Our crack-inducing elements make for a practical variant of sectional weakening.

NEW! ABS crack-inducing element smooth/toothed Coated joint sheet metal with integrated crack-inducing joint rail

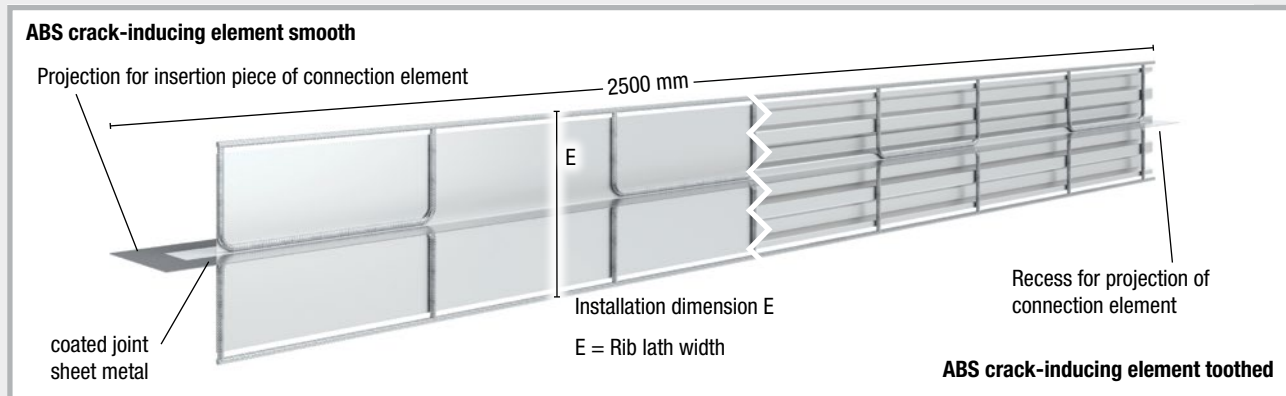

The ABS crack-inducing elements are made of joint sheet metal which is coated with a polymer coating on both sides in the edge area. Crack-inducing rails with integrated mounting projection are fitted on both sides vertically to the joint sheet metal. The installation dimension depends on the thickness of the constructional elements. The crack-inducing rails are available as a smooth (galvanised flat sheet metal) or toothed (galvanised sheet metal with trapezoidal profile) variant.

Waterproofing

- All-round polymer coating on both sides in the edge area
- Proof of usability: abP and ETA
- For joint opening up to 1.0 mm



European Technical Assessment (ETA):

Intended purpose: Sealing element for sealing construction joints in structures made of concrete with high water penetration resistance against pressurised and non-pressurised water.



General Building Supervisory Test Certificate (abP):

2 bar water pressure (20 m water column) with joint opening up to 1.0 mm

Application test:

6 bar water pressure (60 m water column) with joint opening up to 1.0 mm



The carrier and coating material has good to very good resistance to chemicals and other media.

Crack-inducing rails

The version of the crack-inducing rails used is critical for the resultant category of controlled crack in smooth or toothed joint. The geometry of the trapezoidal profile is based on the requirements for toothed joints according to DIN EN 1992-1-1 NA (EC2).

Stopend panels LinkFix/LinkForm

Lost formwork for construction joints in the toothed/rough joint category according to DIN EN 1992-1-1 NA (EC2), prefabricated ready for installation

NEW! LinkFix crack-inducing element

Crack-inducing profile for toothed joints

LinkFix crack-inducing element

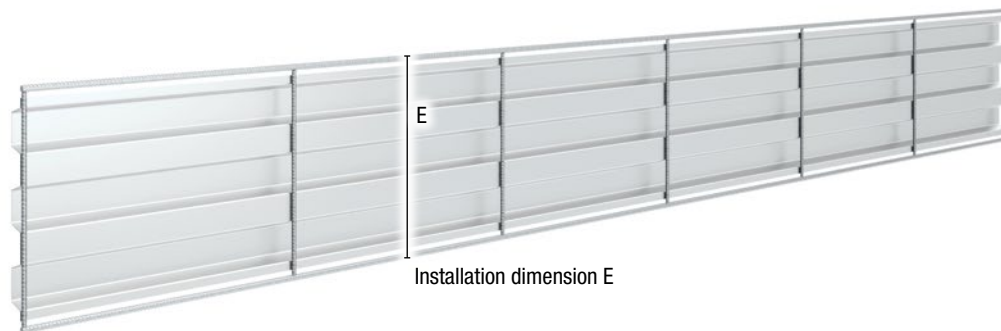

- LinkFix crack-inducing elements for systematic sectional weakening of concrete
- Trapezoidal profile design, geometry based on toothed joints according to DIN EN 1992-1-1 NA (EC2).
- Integrated mounting frame for fastening to the reinforcement
- Suitable for floor slabs and wall installation

NEW! LinkForm crack-inducing element

Crack-inducing profile for smooth joints

LinkForm crack-inducing element

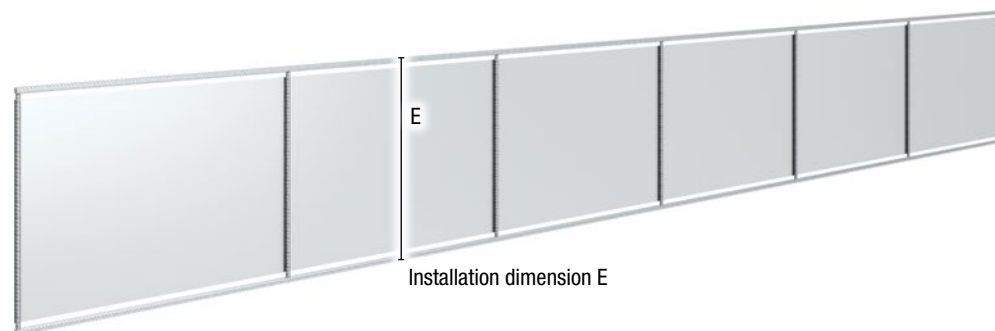

- LinkForm crack-inducing element for systematic sectional weakening of concrete
- Smooth version for straight crack course through the concrete component
- Integrated mounting frame for fastening to the reinforcement
- Suitable for floor slabs and wall installation

ABS joint sheet metal cage rough/toothed

Stopend panel for retrofitting joint sheet metal

- Insertion cage for coated joint sheet metals
- Insertion depth limited at 80 mm
- Rough/toothed joint according to DIN EN 1992-1-1 NA (EC2)
- Ready-to-install, matched to the thickness of the floor slab

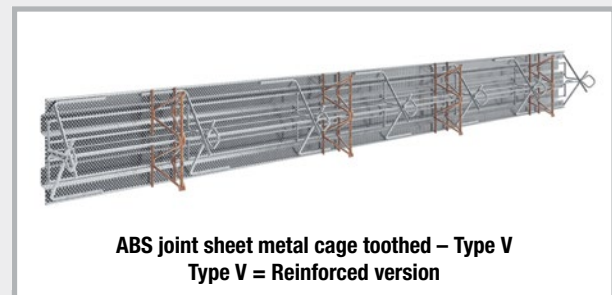
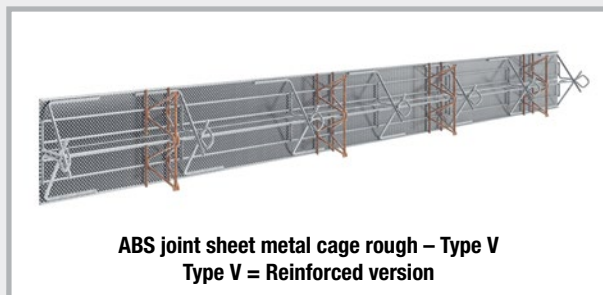
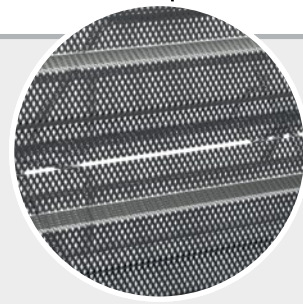
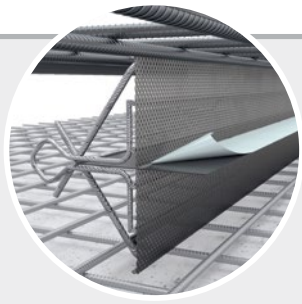
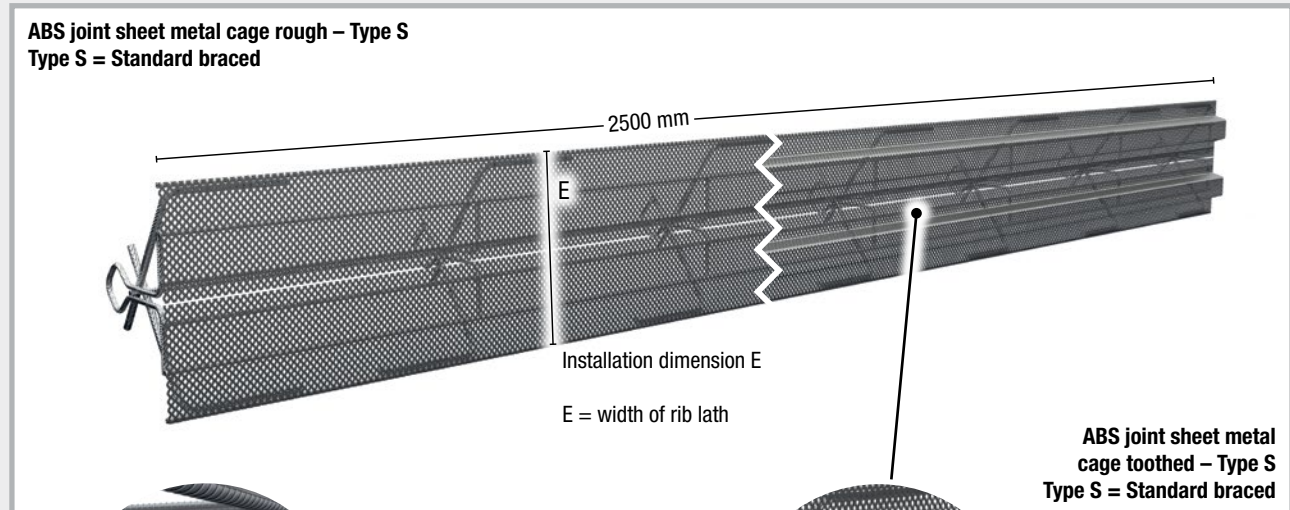

Installation instructions

- Place the ABS joint sheet metal cage elements between the reinforcement layers and fix them with tie wire.
- Peel off the protective foil of the joint sheet metal on the sheet side of the first concreting section and push the joint sheet metal into the insertion cage.
- Overlap the sheet ends of the joint sheet metals to be inserted according to the manufacturer's specifications.
- The ABS joint sheet metal cage elements remain in the concrete, i.e. no time-consuming formwork or stripping required.
- The back anchoring and securing the position of the elements against concrete pressure is carried out at the construction site.

Suitable joint sheet metal for retrofitting: you will find the VB joint sheet metal on page 26.

ABS joint tape cage

NEW! ABS joint tape cage toothed/rough

Sto pend panel for retrofitting joint tapes

- Insertion cage for internal construction joint tapes 190, 240 and 320 mm
- Rough/toothed joint according to DIN EN 1992-1-1 NA (EC2)
- Ready-to-install, matched to the thickness of the floor slab
- Fastened to cage with joint tape clamp

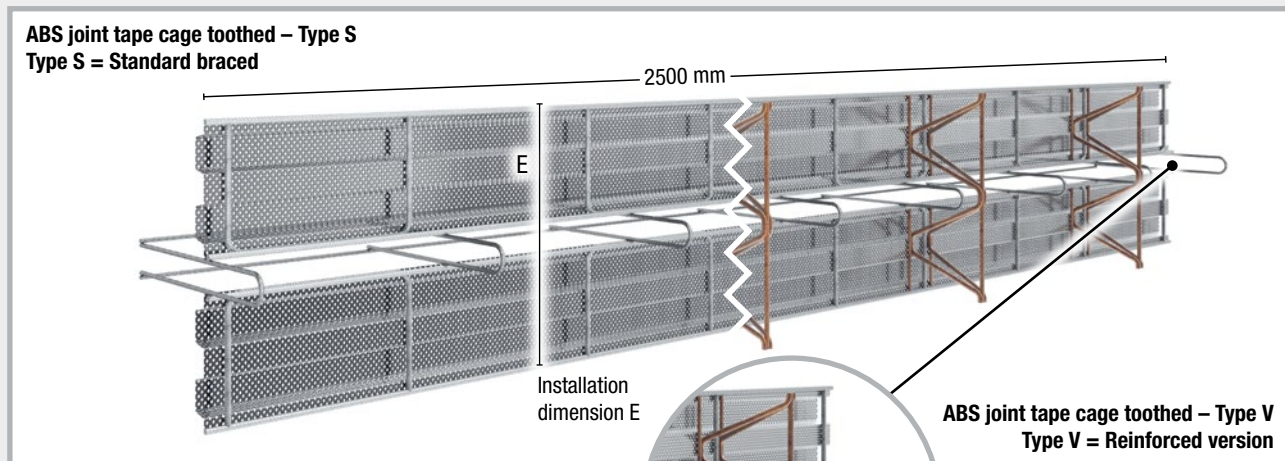

- Toothed joint according to DIN EN 1992-1-1 NA (EC2)
- Type V – with welded on lattice girders for reinforcement
- Insertion opening for joint tape adapted to the joint tape width

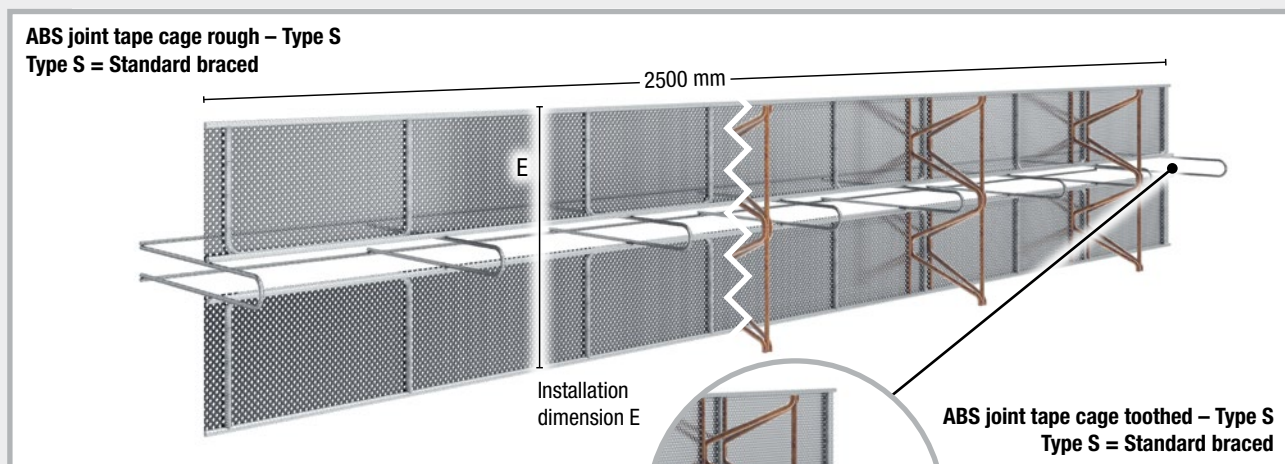

- Rough joint according to DIN EN 1992-1-1 NA (EC2)
- Type V – with welded on lattice girders for reinforcement
- Insertion opening for joint tape adapted to the joint tape width

NEW! ABS joint tape cage deflection profile

Stopend panel for direction changes of joint tapes

The ABS joint tape cage deflection profiles allow for direction changes from horizontal to vertical joint courses. The most common case is the transition from floor slabs to walls.

- Defined bending radius of 150 mm according to DIN 18197 for internal construction joint tapes
- Compatible with ABS joint tape cage

ABS joint tape cage deflection profile toothed

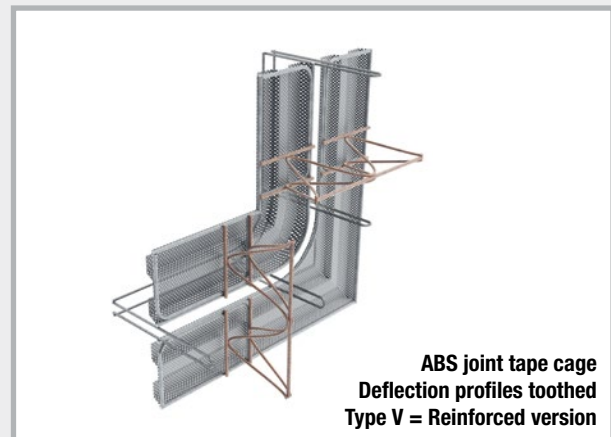
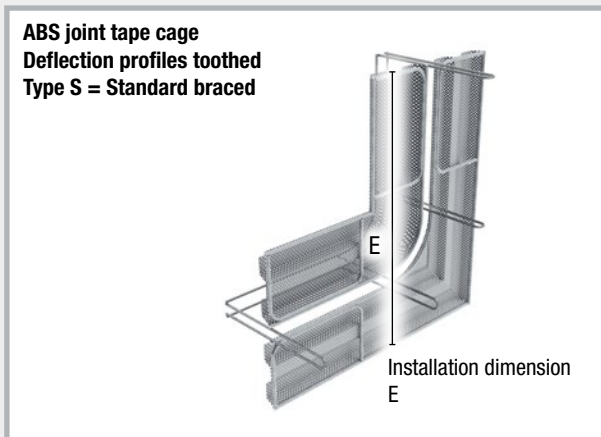

- Toothed joint according to DIN EN 1992-1-1 NA (EC2)
- Type V – with welded on lattice girders for reinforcement

ABS joint tape cage deflection profile rough

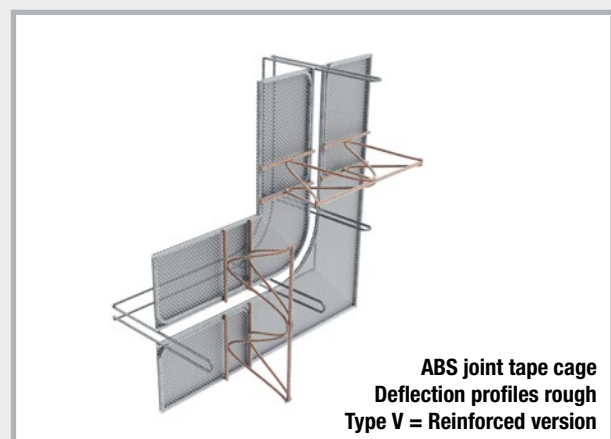
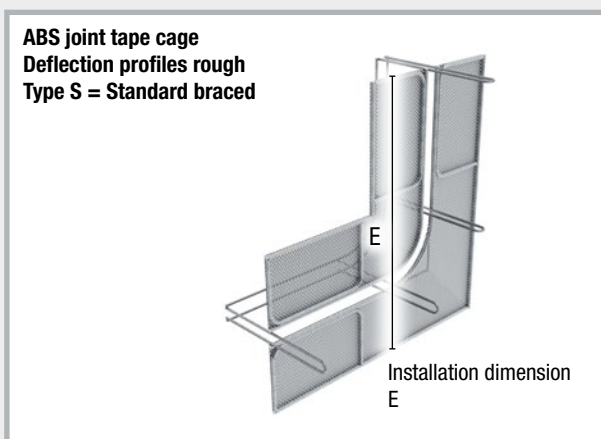

- Rough joint according to DIN EN 1992-1-1 NA (EC2)
- Type V – with welded on lattice girders for reinforcement

Soundproofing joint DSK

Product description

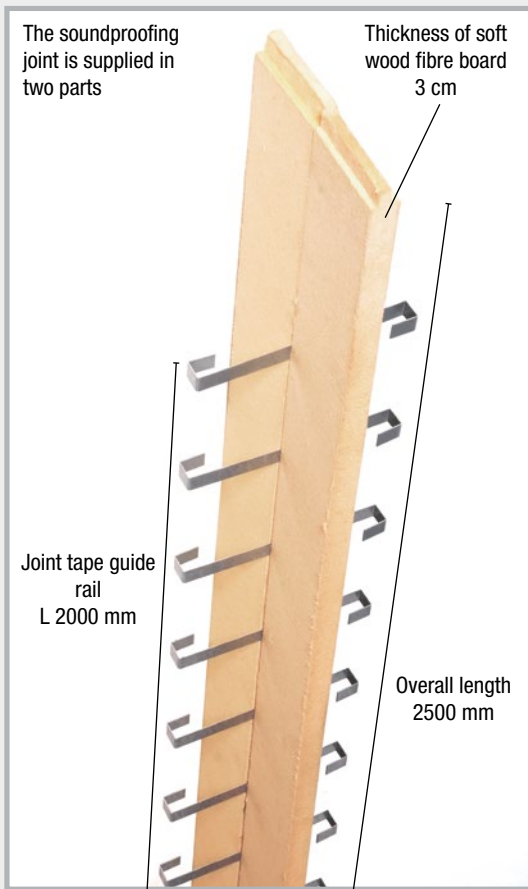

Installation and function

- In the course of concreting of the foundation, the coated area of the sound joint tape DSF is encased in the concrete.
- Remove the foil before concreting.
- In the foundation area, the sound joint tape is connected to the foundation/wall waterproofing element using the joint sheet metal/joint tape connector.
- The soundproofing joint is fastened to the front face of the wall elements.
- The sound joint tape is fed upwards through the joint tape guide rail.
- Secure joint tape with joint tape clamps.

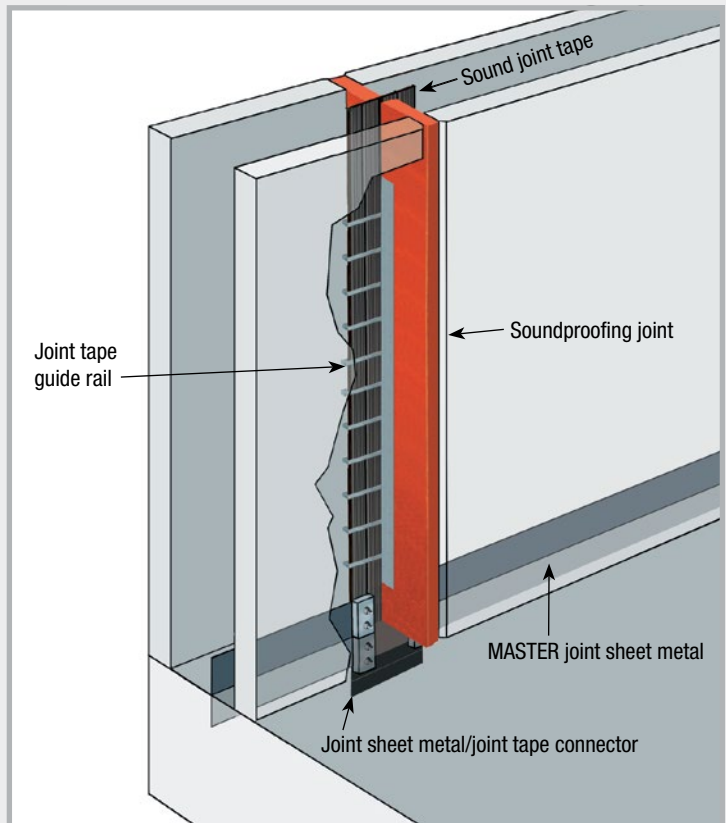

1 SWELLING TAPES
 2 JOINT SHEET METALS
 3 INJECTION HOSES CONSTRUCTION CHEMISTRY
 4 SERVICE DUCTS
 5 LIGHTNING PROTECTION
 6 FORMWORK ACCESSORIES

Joint sheet metal/joint tape connector



Product description

The joint sheet metal/joint tape connector establishes a reliable pressure watertight connection between PVC joint tapes and coated joint sheet metals.

A joint sheet metal/joint tape connector consists of 2 connecting elements.

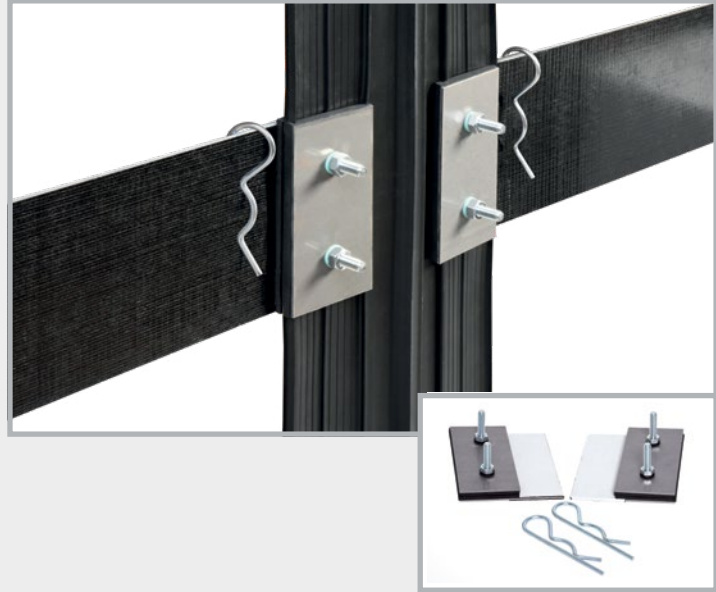

Installation



The ribs must be removed from the joint tape in the areas where the connectors are mounted.



The positions of the bore holes are marked.



The holes are drilled.



The connectors and joint tape are assembled.



The screws are tightened.



Pull off the foil, affix the connection plates and secure with the fixing clips.

MASTER-Connect



Connector for joint sheet metals and joint tapes

MASTER-Connect connectors are manufactured in 2 versions. MASTER-Connect Type F for joint sheet metals and Type B for joint tapes.

- No boreholes
- Supplied ready for installation
- No welding
- Completely pressure watertight connection



Technology

1. The connectors are supplied preassembled.
2. The joint sheet metal elements or joint tapes are pushed in between the seals on the left and right.
3. The ribs are removed at the insertion section of the joint tapes to ensure this section is as smooth as possible.
4. Following insertion the screws are tightened to 8 Nm.
5. The connection is completely pressure watertight.

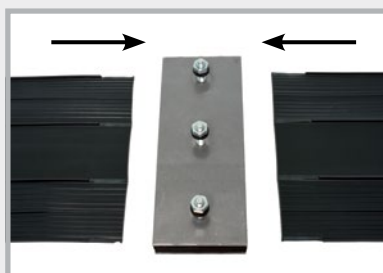
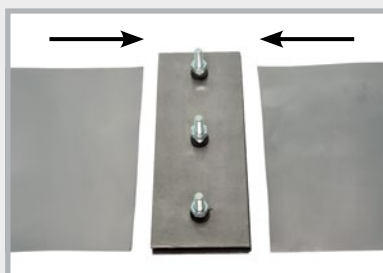

Installation options for joint tape and joint sheet metal

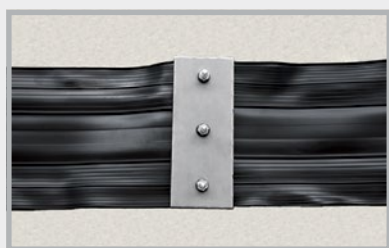

Butt joint

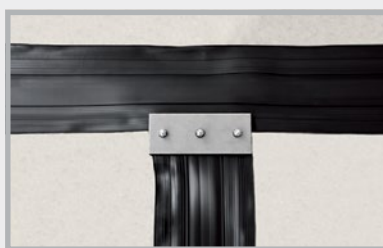

T piece

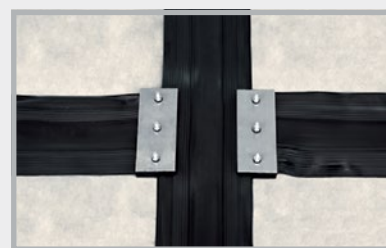

Junction

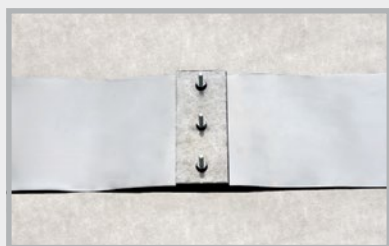

Butt joint



T piece

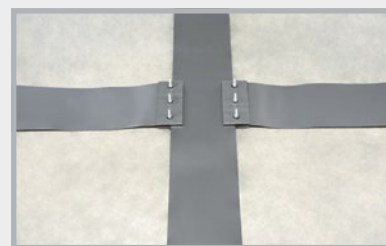

Junction

Technical data and detailed installation instructions can be found at www.mastertec.eu

INJECTION HOSES CONSTRUCTION CHEMISTRY



**MASTERTUBE
YELLOW**
injection hose system
pages 90 – 93



**MASTERTUBE
RED/YELLOW**
injection hose system
pages 90 – 93



**PROTECT resin system
+ Universal concrete adhesive
+ Injection packers**
pages 94 – 96



**LIDOL concrete release agent
in MULTI and BIO quality**
pages 97 – 98

MASTERTUBE injection hose systems



Injection hoses

Art.Gr. 300

Art. no.	Description	PU	Secondary packaging	Weight
030400	MASTERTUBE YELLOW round, size: 6/12 mm, PVC injection hose	1 roll of 100 m	1 pallet = 60 rolls	10.25 kg per roll
030050	MASTERTUBE RED/YELLOW round, size: 6/12 mm, red/yellow Injection hose with woven jacket	1 roll of 100 m	1 pallet = 50 rolls	10.35 kg per roll

- Very high-pressure water test
- For injection with polyurethane resin
- For multiple injection with acrylate
- Hose sections up to 15 m with polyurethane resin



Art. no. 030400



Art. no. 030050

NEW! MASTERTUBE YELLOW installation set

Art.Gr. 301

Art. no.	Description	PU	Weight/set
030055	MASTERTUBE YELLOW installation set 10 m MASTERTUBE YELLOW injection hose 100 plastic fastening clips, type B 2 fastening packers (1 x red, 1 x white), including 2 nipples 2 hose connectors	1 carton = 1 set	1.60 kg

MASTERTUBE RED/YELLOW installation set

Art.Gr. 301

Art. no.	Description	PU	Weight/set
030052	MASTERTUBE RED/YELLOW installation set 40 m MASTERTUBE RED/YELLOW injection hose 20 fastening packers, including nipples 300 plastic fastening clips, type B 10 hose connectors 1 roll of filament tape	1 carton = 1 set	6.10 kg















Art.Gr.
302

Injection hose and accessories

Art. no.	Description	PU	Secondary packaging	Weight per pc.	
030060	Fastening packer, without nipple, for fastening of injection hose to the formwork, Colour of packer: black, 10 red plugs, 10 white plugs, for resin injection	1 bag of 20 pcs.	1 carton = 25 bags	0.50 kg per bag	
030063	Nipples for fastening packers	1 bag of 20 pcs.		0.10 kg per bag	
030362	Plastic foam for fastening packer Diameter 35 mm, Thickness 20 mm, self-adhesive, 10 pcs. white, 10 pcs. anthracite	1 bag of 20 pcs.		0.04 kg per bag	
030065	Fixing spider for fixing the fastening packer to the reinforcement	1 pc.		0.08 kg	
030075	Plastic fastening clip type A to be pressed into the fresh concrete, distance between clips: 15 cm	1 bag of 100 pcs.	1 sack = 25 bags	0.29 kg per bag	
030070	Plastic fastening clip type B for pressing into the fresh concrete or into Ø 8 mm bore holes, distance between clips: 15 cm	1 bag of 100 pcs.	1 sack = 25 bags	0.29 kg per bag	
030080	Metal clip with pre-fitted nail for all common nailguns, for firing and nailing, distance between clips: 15 cm	1 carton of 100 pcs.		1.75 kg per carton	
030081	Metal clip without nail	1 carton of 100 pcs.		1.40 kg per carton	
030083	Nail plug 5 x 40 mm borehole Ø 5 mm	1 carton of 200 pcs.		0.63 kg per carton	
030072	Fastening grid for MASTERTUBE 1 carton = 25 m (25 grids of 1 m)	1 carton		1.65 kg per carton	
030082	MASTERTUBE joint tape clamp	1 bag of 100 pcs.		0.60 kg per bag	

Injection hose and accessories

Art. no.	Description	PU	Weight per pc.	
030100	Hose connector for hose extension and connection of oddments	1 bag of 10 pcs.	0.03 kg per bag	
030102 030104	Ventilation hose Fabric hose blue-transparent round, size: 5/11 mm red-transparent round, size 5/11 mm	1 roll of 50 m	5.50 kg 5.50 kg per roll	
030112	Injection end pieces including sealing plug and hose connector, length 50 cm blue-transparent round 5/11 mm	1 bag of 10 pcs.	0.60 kg per bag	
030114	red-transparent round 5/11 mm	1 bag of 10 pcs.	0.60 kg per bag	
030096	Sealing plugs for injection end pieces and ventilation hose	1 bag of 20 pcs.	0.01 kg per bag	
030350	Storage box for ventilation hose	1 bag of 10 pcs.	0.73 kg per bag	
030140	Hand-lever press 500 ccm for resin injection	1 pc.	1.05 kg	
030150	Reinforced hose L 300 mm incl. gripping head	1 pc.	0.09 kg	
030160	Gripping head	1 pc.	0.03 kg	
030165	Manometer 400 bar with T piece incl. connecting tube and adapter	1 pc.	0.28 kg	
030130	Injection packer, including nipple for injection via ventilation hose or injection hose	1 bag of 10 pcs.	0.13 kg per bag	
030090	Filament tape roll width: 25 mm, roll length: 50 m to safeguard the hose ends	1 carton of 36 rolls	0.22 kg per roll	

1 SWELLING TAPES
2 JOINT SHEET METALS
3 INJECTION HOSES CONSTRUCTION CHEMISTRY
4 SERVICE DUCTS
5 LIGHTNING PROTECTION
6 FORMWORK ACCESSORIES

MASTERTUBE injection hose systems



Two systems with 100% reliability

The MASTERTUBE YELLOW and MASTERTUBE RED/YELLOW injection hoses make construction joints watertight. The form and structure of the hose profiles ensure a particularly secure and even filling of shrinkage gaps and damaged spots.



Both systems are also available as an installation set.

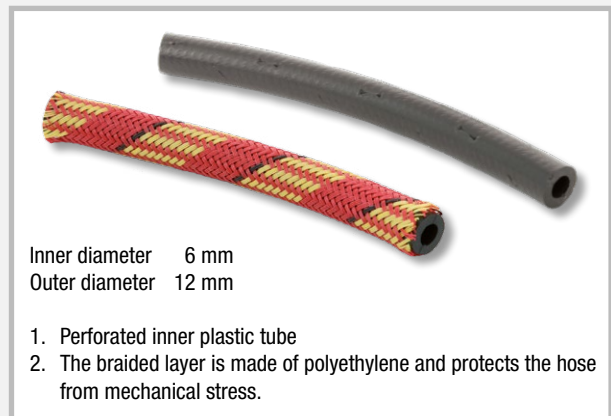
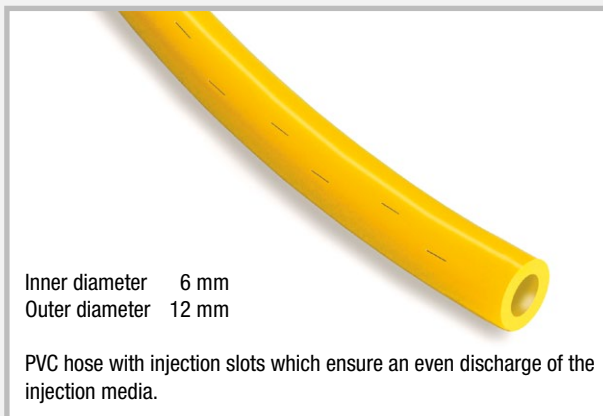

	MASTERTUBE YELLOW	MASTERTUBE RED/YELLOW
Very high water pressure tests	50 m water column	50 m water column
For injection with polyurethane resin	tested	tested
For multiple injection with acrylate	tested	tested
Additional 15 m circulation with polyurethane resin	tested	tested
Even discharge of injection material	tested	tested
No sintering during concreting	tested	tested
Suitable for zones with frequently varying water levels	tested	tested
All-weather installation	-10°C to + 60°C	-10°C to + 60°C
Extremely straightforward installation	Used on building sites for more than 10 years	Used on building sites for more than 20 years
Accessories	Comprehensive system	Comprehensive system

PROTECT resin system



Injection resins, adhesives and cleaning agents for injection of injection hoses and injection packers and pressure water-tight bonding of fibre cement plugs.

Universal concrete adhesive

PROTECT Easy 1K



Single-component polymer-based concrete adhesive

For water-tight bonding of all fibre cement distance tubes and fibre cement lining pipes.

Processing takes approx. 20 min. at +23°C;

Resistant to all normal uncontaminated groundwater.



Art.Gr.
308

Art. no.	Description	PU	Secondary packaging	Weight/aluminium bag
040030	PROTECT Easy 1K in aluminium bag 800 g	1 aluminium bag	1 carton = 3 aluminium bags 1 outer box = 10 cartons	0.80 kg

PROTECT BK 2K



Solvent-free epoxy-based concrete adhesive

For water-impermeable bonding and non-positive connection of concrete components.
Processing time approx. 60 min. at +20°C

Resistances of PROTECT BK once cured:

Diluted acids, mineral oil, lubricants and fuels, salt water, waste water, large number of alkalis and solvents, approved for use in contact with drinking water

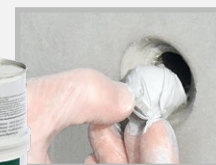

Art.Gr.
308

Art. no.	Description	PU	Secondary packaging	Weight
040100	PROTECT BK 2K for pressure water-tight sealing of fibre cement distance tubes.	1 kg combination can: (0.5 kg component A + 0.5 kg component B)	1 carton = 10 cans 1 pallet = 28 cartons	1.20 kg per can

PROTECT Clean

Cleaning agent

For cleaning of polyurethane and epoxy resin prior to curing.



Art.Gr.
303

Art. no.	Description	PU	Secondary packaging	Weight
040045	PROTECT Clean	1 can 1 l	1 carton = 12 cans	0.96 kg/can
040040	PROTECT Clean	1 canister 10 l	1 canister	9.45 kg/canister

MC-Injekt 2300 top

Polyurethane resin for hose and crack injection

CE marking; low viscosity and provides permanently elastic seal;
Processing time of approx. 35 min. at +20°C;



Art.Gr.
303

Art. no.	Description	PU	Secondary packaging	Weight
040015	MC-Injekt 2300 top polyurethane resin	1 l combination can: (0.5 l component A + 0.5 l component B)	1 carton = 6 cans	1.30 kg per can
040018	MC-Injekt 2300 top polyurethane resin	10 l canister: (5 l component A + 5 l component B)	1 canister	11.55 kg per canister

Application

All resins must be very well homogenised when stirred in.
Example MC-Injekt 2300 top:

Installation instructions, technical data and data sheets can be found on our website:
www.mastertec.eu

Resins and adhesives cannot be shipped at temperatures below +5°C.

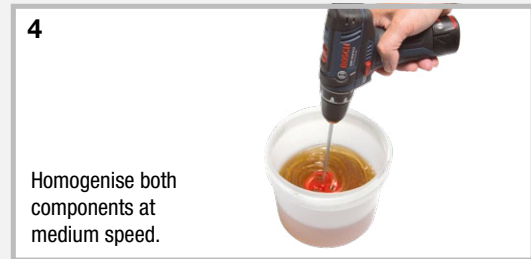

MC-Injekt 1264 compact

Epoxy resin

Non-positive filling of cracks and joints;
Injection into injection hoses;
Suitable for dry and damp substructures;
Processing time approx. 25 min. at +20°C;



Art.Gr.
303

Art. no.	Description	PU	Secondary packaging	Weight
040020	MC-Injekt 1264 compact epoxy resin	1 l combination can: (800 ml component A + 200 ml component B)	1 carton = 6 cans	1.35 kg per can

MC-Injekt 2133

Single-component, fast-foaming polyurethane-based foam resin

Immediately stops the inflow of water; rapid expansion with high increase in volume;
Reaction time upon contact with water approx. 10-15 seconds;



Art.Gr.
303

Art. no.	Description	PU	Secondary packaging	Weight
040050	MC-Injekt 2133 foam resin	1 l can	1 carton = 6 cans	1.30 kg per can

Injection packers / surface packers

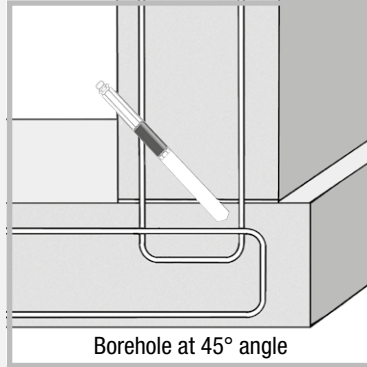
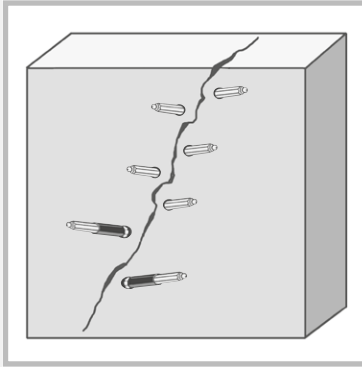

Art. no.	Screw injection packer including nipple / size	Drill bit Ø	PU	Weight per carton
030185	10/70 mm	10 mm	1 carton of 100 pcs.	1.90 kg
030187	10/100 mm	10 mm	1 carton of 100 pcs.	2.70 kg
030183	13/80 mm	14 mm	1 carton of 100 pcs.	2.90 kg
030180	13/100 mm	14 mm	1 carton of 100 pcs.	4.65 kg
030181	13/170 mm	14 mm	1 carton of 100 pcs.	7.60 kg
030182	13/250 mm	14 mm	1 carton of 100 pcs.	10.80 kg

One day site packer

Art.Gr. 304

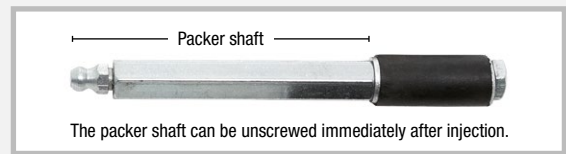

Art. no.	One day site packer including nipple / size	Drill bit Ø	PU	Weight per carton
030188	10/110 mm	10 mm	1 carton of 100 pcs.	4.00 kg
030189	13/115 mm	14 mm	1 carton of 100 pcs.	4.60 kg

Surface packer

Art.Gr. 304

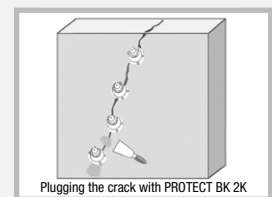

Art. no.	Description	PU	Weight
030200	Plastic surface packers, washer diameter 5 cm	1 bag of 100 pcs.	1.70 kg per bag

Plastic injector

Art.Gr. 304

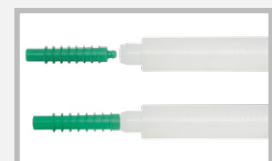
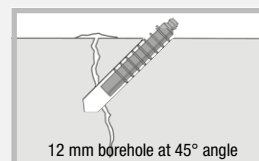
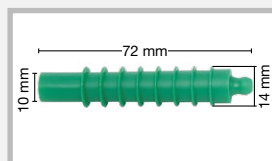



Art. no.	Description	PU	Weight
030210	Plastic injector with non-return ball	1 bag of 200 pcs.	0.80 kg per bag
030215	Impact stud	1 pc.	0.07 kg/pc.

1 SWELLING TAPES
2 JOINT SHEET METALS
3 INJECTION HOSES CONSTRUCTION CHEMISTRY
4 SERVICE DUCTS
5 LIGHTNING PROTECTION
6 FORMWORK ACCESSORIES

LIDOL concrete release agent

Art.Gr.
305

Art. no.	Description	PU	Secondary packaging	Weight	
040310	LIDOL MULTI	1 canister 20 l	Pallet: 30 canisters	18.0 kg per canister	 Drum
040320	LIDOL MULTI	1 drum 200 l with integrated faucet	Pallet: 2 drums	184.6 kg per drum	
040330	LIDOL BIO 	1 canister 20 l	Pallet: 30 canisters	18.0 kg per canister	 20 l canister

LIDOL MULTI

LIDOL MULTI is an environmentally sound universal release agent

The application of LIDOL MULTI to the formwork prevents the formwork from coming into contact with the concrete. The formwork can therefore be easily stripped.

Applications:

- For all common formwork types
- With fair-faced concrete
- When coating concrete surfaces with plaster, stucco or similar material, e.g. wallpaper, paint, ceramic
- Does not contain corrosion protection additives, corrosion protection is provided by mineral oils

Environmental aspects:

- Water hazard class 1 = low hazard to water
- Not subject to mandatory labelling
- Flashpoint > +120°C
- Neutral odour

Application:

LIDOL MULTI is not sensitive to frost and can be used without problems in all weather conditions. The release agent can be applied by spraying, brushing or rolling. The most economical application method is using a compression sprayer.



LIDOL BIO

LIDOL BIO is an environmentally sound and highly biodegradable universal release agent

Special award:

Due to its high environmental compatibility, LIDOL BIO was awarded the environmental label “Blue Angel” by RAL Deutsches Institut für Gütesicherung und Kennzeichnung e.V (German Institute for Quality Assurance and Labelling).



Applications:

- In water protection areas and zones with environmental stipulations
- For all common formwork types
- With fair-faced concrete
- When coating concrete surfaces with plaster, stucco or similar material, e.g. wallpaper, paint, ceramic



Environmental aspects:

- Water hazard class 1 = low hazard to water, highly biodegradable
- Not subject to mandatory labelling
- Flashpoint > +120°C
- Neutral odour



Application:

LIDOL BIO is not sensitive to frost and can be used without problems in all weather conditions. The release agent can be applied by spraying, brushing or rolling. The most economical application method is using a compression sprayer.

Types of formwork	Yield per 1 litre of LIDOL BIO	Yield per 1 litre of LIDOL MULTI
formwork panels	approx. 75 m ²	approx. 80 m ²
planed timber surface	approx. 35 m ²	approx. 40 m ²
unplaned timber surface	approx. 25 m ²	approx. 30 m ²

PRESSURE WATER-TIGHT SERVICE DUCTS

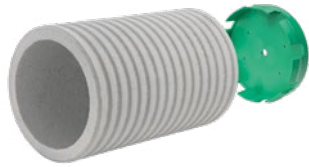

FIX formwork aid & Master-Home-Connect

pages 100 – 109



Lining pipes & accessories

pages 110 – 119



Gasket inserts, modular seals, FLEX 2000

pages 120 – 129



RONDO sealing collars

pages 130 – 134



Pipe bushings and ground drains

pages 135 – 142

FIX formwork aid

NEW! Fastening system for lining pipes and fixed earthing terminals at the construction site and at the precast plant

For nailing to wood and plastic formworks and for fastening to steel formworks using FIX Magnet

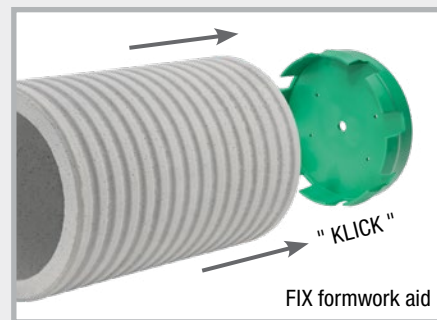

All parts of the FIX formwork range are reusable

Art.Gr.
420

Art. no.	Description	PU	Weight per pc.	
091410	FIX Magnet for formwork aid Power Magnet for all FIX formwork aids, incl. screw and wing nut	25 pcs.	0.14 kg	
090804	FIX EFP formwork aid for fixed earthing terminals M10/12 and M12, cone height 11 mm	25 pcs.	0.03 kg	
090806	FIX 80 formwork aid for lining pipes ID 79-84 mm	25 pcs.	0.10 kg	
090810	FIX 100 formwork aid for lining pipes ID 99-104 mm Sewage pipe DN 110	25 pcs.	0.15 kg	
090814	FIX 110 formwork aid for lining pipes ID 109-114 mm for the socket of KG and KG 2000 sewage pipes DN 110	25 pcs.	0.16 kg	
090816	FIX 125 formwork aid for lining pipes ID 124-129 mm for the socket of KG and KG 2000 sewage pipes DN 125	25 pcs.	0.20 kg	
090818	FIX 150 formwork aid for lining pipes ID 149-154 mm Sewage pipe DN 160	25 pcs.	0.25 kg	
090822	FIX 200 formwork aid for lining pipes ID 199-206 mm	25 pcs.	0.38 kg	
090824	FIX screw adapter incl. screw set The screw adapter allows the FIX formwork aid to be fastened to the formwork shell. In the process, the screw connection is on the outside of the formwork, making stripping the formwork after concreting much easier.	1 set	0.04 kg	
090826	FIX removal aid The removal aid makes pulling out the formwork aid easier	1 pc.	0.08 kg	

Installation of the FIX formwork aid for all common lining pipes

Wooden or plastic formwork

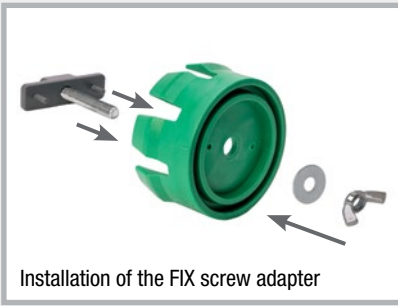

Installation of the FIX screw adapter

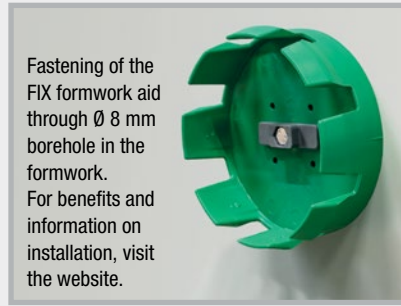

Fastening of the FIX formwork aid through Ø 8 mm borehole in the formwork. For benefits and information on installation, visit the website.



Fastening without screw adapter with nails. For easy stripping of formwork, do not use screws.

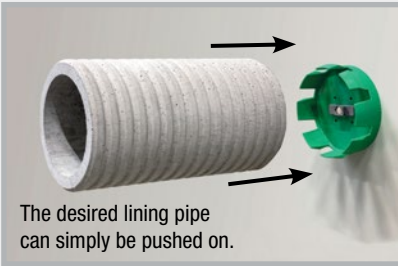

The desired lining pipe can simply be pushed on.

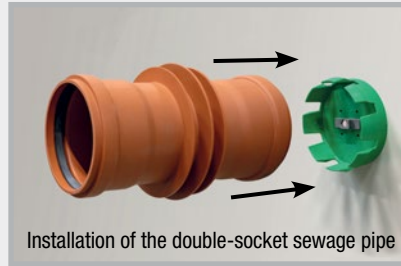

Installation of the double-socket sewage pipe



At the construction site

Steel formwork

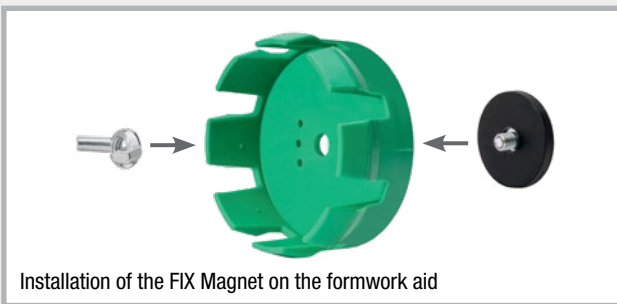

Installation of the FIX Magnet on the formwork aid

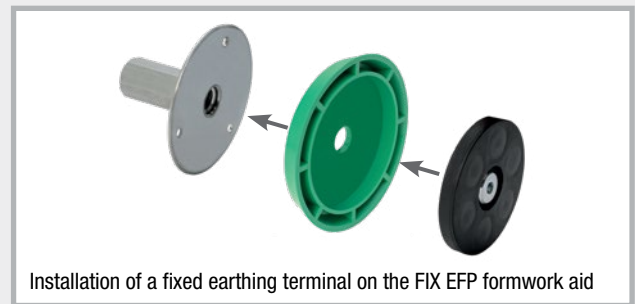

Installation of a fixed earthing terminal on the FIX EFP formwork aid

Position the FIX formwork aid using the FIX Magnet and simply push on the desired lining pipe.

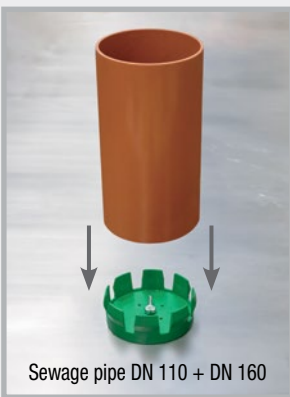

Sewage pipe DN 110 + DN 160

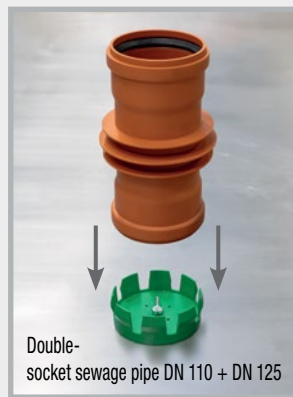

Double-socket sewage pipe DN 110 + DN 125



Corrugated sheathing pipe DN 80 – DN 200

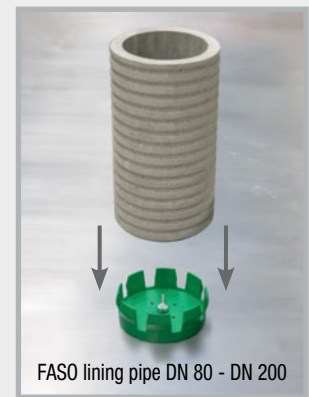

FASO lining pipe DN 80 - DN 200

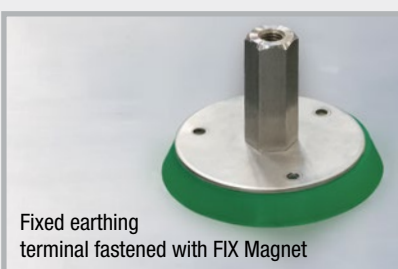

Fixed earthing terminal fastened with FIX Magnet

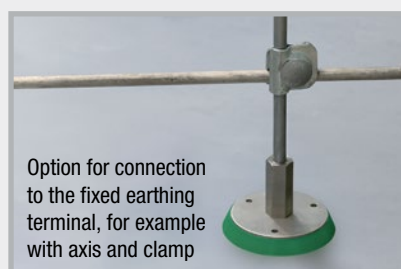

Option for connection to the fixed earthing terminal, for example with axis and clamp



Fixed earthing terminal after stripping of formwork

Master-Home-Connect (MHC)

Service duct system for house connections for electricity, water and telecommunications

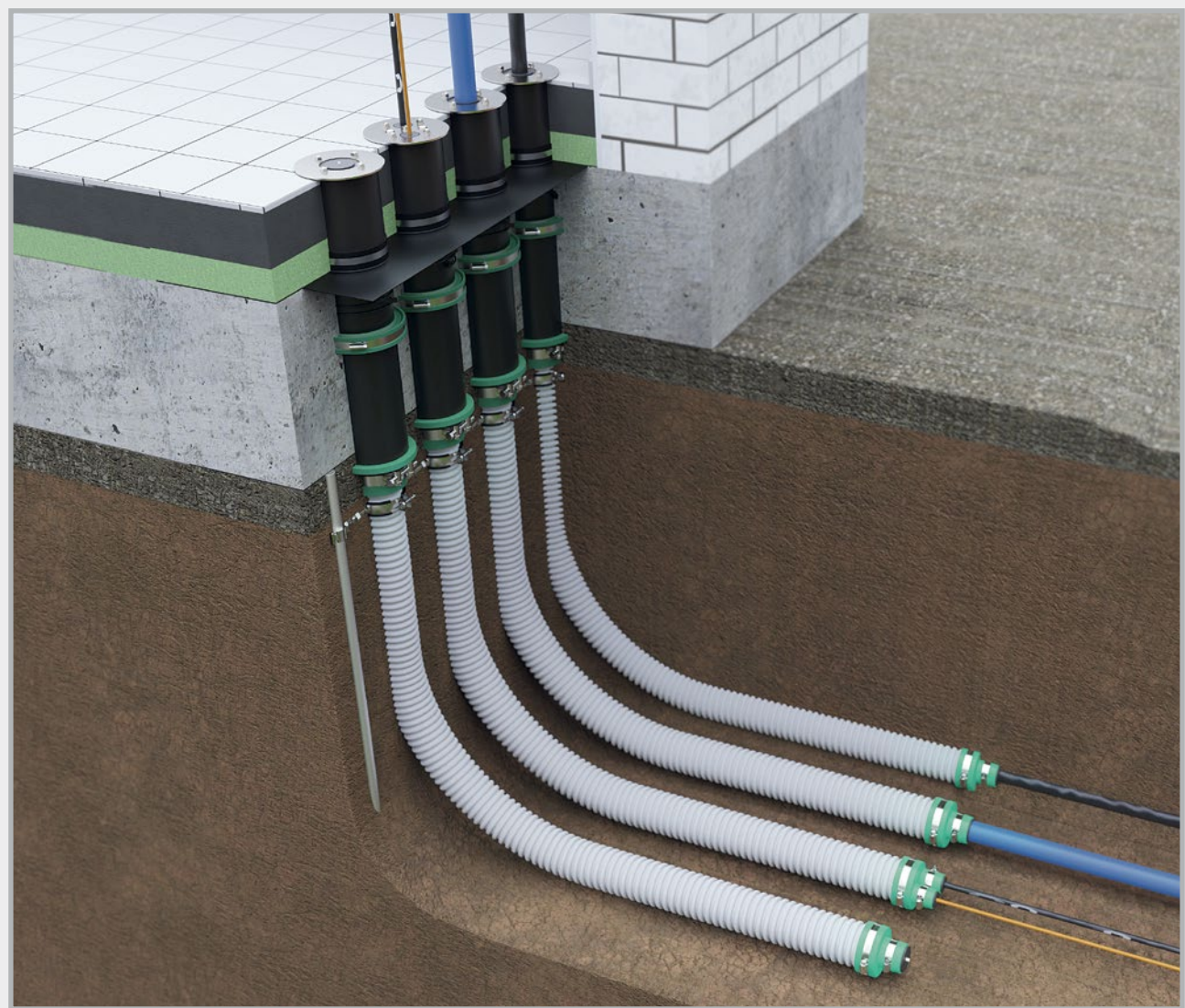

Certified service duct system according to DVGW VP 601 03/2007 chapter 4.5
Impermeability to gas and water of the installed service duct



Each individual component has been tested additionally for pressure water-tightness



Test for impermeability to radon when installed

NEW! Master-Home-Connect single-utility Solo

for on-site cable conduit, for floor slab installation

Art.Gr.
410

Art. no.	Description	PU	Weight per set
080034	MHC single-utility Solo The MHC single-utility Solo set comprises: – 0.6 m lining pipe (with protective cover for the duration of construction) incl. sealing collar, with factory-installed Connector and installation scale – MHC Solo gasket insert – Solid ground stake \varnothing 20 mm – Dual-thread clamp and connecting clamp – 1 set each of MHC Solo and Duo spacers – Solo cable conduit end cap with Multi insert	1 set	7.42 kg
			

NEW! Master-Home-Connect single-utilityincl. cable conduit \varnothing 75 mm, for floor slab installationArt.Gr.
410

Art. no.	Description	PU	Weight per set
	The basic equipment of MHC single-utility comprises: – 0.6 m lining pipe (with protective cover for the duration of construction) incl. sealing collar, with factory-installed Connector and installation scale – MHC Solo gasket insert – Solid ground stake \varnothing 20 mm – Dual-thread clamp and connecting clamp – 1 set each of MHC Solo and Duo spacers – Solo cable conduit end cap with Multi insert		
			
080035	MHC single-utility 3 m The MHC single-utility 3 m set contains the above basic equipment and in addition – 3.0 m cable conduit \varnothing 75 mm (external)	1 set	9.14 kg
080036	MHC single-utility 5 m The MHC single-utility 5 m set contains the above basic equipment and in addition – 5.0 m cable conduit \varnothing 75 mm (external)	1 set	10.28 kg
080037	MHC single-utility 10 m The MHC single-utility 10 m set contains the above basic equipment and in addition – 10.0 m cable conduit \varnothing 75 mm (external)	1 set	13.13 kg

NEW! MHC multi-utility triple setsArt.Gr.
410

for floor slab installation

Art. no.	Description	PU	Weight per set
	<p>The basic equipment of MHC multi-utility triple set comprises:</p> <ul style="list-style-type: none"> – 3 x 0.6 m lining pipes (with protective cover for the duration of construction) incl. sealing collar, with factory-installed Connector and installation scale – 2 x MHC Solo gasket inserts – 1 x MHC Multi gasket insert for telecommunications line – 2 x solid ground stakes \varnothing 20 mm and connection clamps – 3 x dual-thread clamps – 2 sets Duo spacers – 2 x Solo cable conduit end caps with Multi insert – 1 x Duo cable conduit end cap with Multi insert 		
080038	<p>MHC multi-utility triple/3 metre</p> <p>The MHC multi-utility triple/3 metre set contains the above basic equipment and in addition:</p> <ul style="list-style-type: none"> – 3 x 3.0 m cable conduits outside \varnothing 75 mm 	1 set	25.34 kg
080039	<p>MHC multi-utility triple/5 metre</p> <p>The MHC multi-utility triple/5 metre set contains the above basic equipment and in addition:</p> <ul style="list-style-type: none"> – 3 x 5.0 m cable conduits outside \varnothing 75 mm 	1 set	28.76 kg
080040	<p>MHC multi-utility triple/10 metre</p> <p>The MHC multi-utility triple/10 metre set contains the above basic equipment and in addition:</p> <ul style="list-style-type: none"> – 3 x 10.0 m cable conduits outside \varnothing 75 mm 	1 set	37.31 kg

NEW! MHC multi-utility quadruple setsArt.Gr.
410

for floor slab installation

Art. no.	Description	PU	Weight per set
	<p>The basic equipment of MHC multi-utility quadruple set comprises:</p> <ul style="list-style-type: none"> – 4 x 0.6 m lining pipes (with protective cover for the duration of construction) incl. sealing collar, with factory-installed Connector and installation scale – 3 x MHC Solo gasket inserts – 1 x MHC Multi gasket insert for telecommunications line – 2 x solid ground stakes \varnothing 20 mm and connection clamps – 4 x dual-thread clamps – 3 sets MHC Duo spacers – 3 x Solo cable conduit end caps with Multi insert – 1 x Duo cable conduit end cap with Multi insert 		
080041	<p>MHC multi-utility quadruple/3 metre</p> <p>The MHC multi-utility quadruple/3 metre set contains the above basic equipment and in addition:</p> <ul style="list-style-type: none"> – 4 x 3.0 m cable conduits outside \varnothing 75 mm 	1 set	30.48 kg
080042	<p>MHC multi-utility quadruple/5 metre</p> <p>The MHC multi-utility quadruple/5 metre set contains the above basic equipment and in addition:</p> <ul style="list-style-type: none"> – 4 x 5.0 m cable conduits outside \varnothing 75 mm 	1 set	35.04 kg
080043	<p>MHC multi-utility quadruple/10 metre</p> <p>The MHC multi-utility quadruple/10 metre set contains the above basic equipment and in addition:</p> <ul style="list-style-type: none"> – 4 x 10.0 m cable conduits outside \varnothing 75 mm 	1 set	46.44 kg

NEW! MHC single-utility – wall – SoloArt.Gr.
410

for wall installation

Art. no.	Description	PU	Weight per set
080044	MHC single-utility – wall – Solo The MHC single-utility – wall – Solo set comprises: <ul style="list-style-type: none"> – 0.365 m lining pipe (with protective cover for the duration of construction) incl. sealing collar and length scale – Connector for connecting the cable conduit – MHC Solo gasket insert – 1 set each of MHC Solo and Duo spacers – Solo cable conduit end cap with Multi insert 	1 set	3.78 kg
080045	MHC single-utility – wall – Multi The MHC single-utility – wall – Multi set comprises: <ul style="list-style-type: none"> – 0.365 m lining pipe (with protective cover for the duration of construction) incl. sealing collar and length scale – Connector for connecting the cable conduit – MHC Multi gasket insert for telecommunications line – 1 set each of MHC Solo and Duo spacers – Duo cable conduit end cap with Multi insert 	1 set	3.80 kg

NEW! Master-Home-Connect accessoriesArt.Gr.
410

Art. no.	Description	PU	Weight per pc.
080052	MHC Solo end cap (Set) 1 media line: 4-40 mm	1 set	0.25 kg per set
080053	MHC Duo end cap (Set) up to 2 media lines: each 4-25 mm	1 set	0.25 kg per set
080047	MHC Multi gasket insert up to 4 media lines: 2 x 4-25 mm + 2 x 10 mm	1 pc.	0.81 kg
080046	MHC Solo gasket insert 1 media line: 4-40 mm	1 pc.	0.79 kg
080050	MHC Solo spacer	1 set	0.02 kg per set
080051	MHC Duo spacer	1 set	0.04 kg per set
080012	Cable conduit Ø 75 mm	1 m	0,53 kg per m
080033	Foil flange for MHC, quadruple, size: 800 x 250 mm, suitable for on-site adjustment	1 pc.	0.47 kg

Master-Home-Connect (MHC)

Individual components



Lining pipe

Plastic lining pipe with length of 0.6 m and pre-installed RONDO Base sealing collar, Connector connection seal and length scale. The sealing collar seals off the transition between the concrete and lining pipe so that it is impermeable to pressurised water and gas.

The Connector connection seals connect the cable conduits DN 75 mm so that they are pressure water-tight.



Cable conduit

Pressure-resistant protective conduit DN 75 mm for electrical, water and telecommunications lines laid in the soil.

Alongside its excellent pressure resistance, the protective conduit which is classified as N750 according to DIN EN 61386-24, provides perfect insertion properties thanks to the sliding, green inner layer.

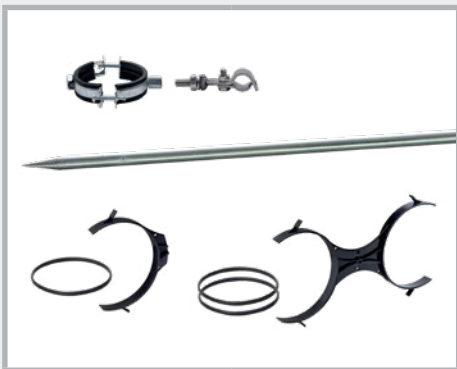

Fastening material

Dual-thread clamps for positioning multiple cable conduits with defined spacing in a row or as a package.

Connection clamp for connection of the dual-thread clamps to the ground stake.

Solid ground stake for positioning the dual-thread clamps in the ground.

MHC Solo and Duo spacers for connection and plumb alignment of the lining pipes.

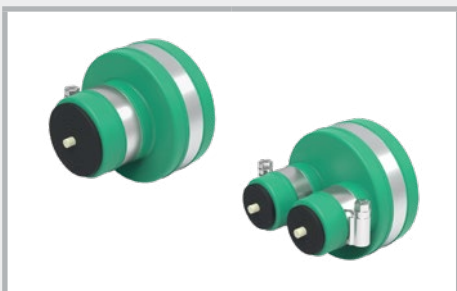

MHC end caps

Rubber end seal for waterproofing the ends of the cable conduit at the transition point.

The Multi insert allows adaptation to the media line being inserted.

MHC Solo end cap (set): 1 media line 4-40 mm

MHC Duo end cap (set): up to 2 media lines, each 4-25 mm



MHC gasket inserts

Gasket insert for waterproofing the transition of the lining pipe to the inserted media line.

The gasket insert can be adapted to all common medium pipes thanks to the Multi inserts which can be adjusted to the medium pipe.

MHC Solo gasket insert:

1 media line 4-40 mm

MHC Multi gasket insert:

up to 4 media lines 2 x 4-25 mm + 2 x 10 mm

The 130 mm pressure plate covers the transition area between the lining pipe and floor covering with its projection.

Master-Home-Connect (MHC) Installation

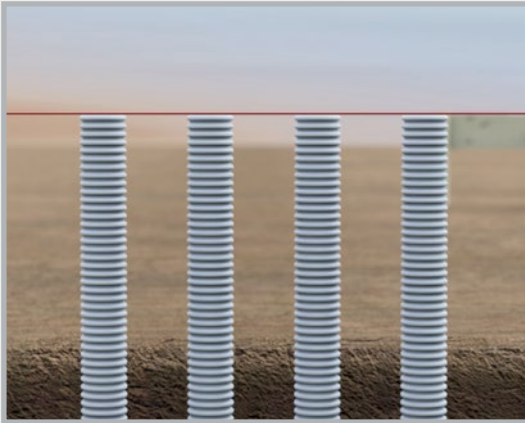

Laying the cable conduit

The cable conduits are directed from the transition point up to the desired insertion point under the floor slab, and up to at least the height of the top edge of the floor slab with a bending radius > 350 mm.

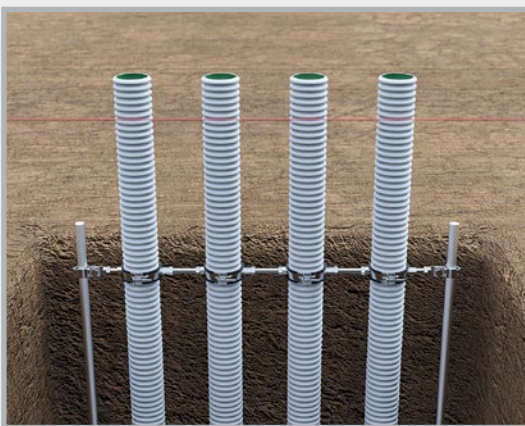

Fastening the cable conduit

The cable conduits are connected with the spacing in a row defined for the installation using the dual-thread clamps. The connection clamp is used to establish a connection between the dual-thread clamps and the ground stake on both sides, which is driven into the soil beforehand. The height position of the connection clamp is positioned at least 400 mm underneath the top edge of the floor slab, and secured with screws.



Sealing the cable conduit/backfilling

The ends of the cable conduit are sealed with the supplied construction protective covers. The trench for the cable conduits can then be filled with suitable filling material and waterproofed in layers.



Installation of the MHC lining pipe

The cable conduits are then cut 360 mm underneath the top edge of the floor slab. The end of the MHC lining pipe, which is equipped with the Connector, is pushed over the end of the cable conduit, and secured by tightening the metal clamp.

The plumb position of the lining pipe is not yet relevant at this point.

Master-Home-Connect (MHC) Installation



Connection of the MHC lining pipes

The MHC lining pipes are connected to each other using Duo spacers. For this purpose, the pipes are clipped into the spacers and secured using the supplied rubber fastening straps.



The spacers are positioned at the height of the upper layer of reinforcement.



Floor slab substrate

The substrate for the floor slab can subsequently be prepared in the form of gravel or grit bedding. When concreting a blinding layer, the MHC service duct must be shuttered. As a result, the elastic bearing remains in place for subsequent plumb alignment.



Preparation of the floor slab

The formwork of the floor slab is put in place. The reinforcement of the floor slab is inserted.



Plumb alignment/concreting

After inserting the upper layer of reinforcement, the MHC lining pipes are aligned plumb.

The securing holes of the spacers can be used to secure the plumb position to the upper layer of reinforcement using tie wire.

After alignment and securing, the floor slab can be concreted.

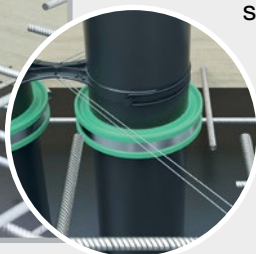

Master-Home-Connect (MHC) Installation



Connection of the floor slab vapour barrier

A foil flange seal made of PVC foil with a thickness of 1.5 mm, suitable for the MHC service duct system, for the integration of the surface-wide vapour barrier on the floor slab, is available. It is designed in the factory for the quadruple row arrangement. The foil flange is pushed over the lining pipes from the inside of the structure and clamped to the pipe body with fastening straps. The surface waterproofing is processed on the flange. When using fewer than 4 lining pipes, the foil flange can be cut off on site.



Floor construction

The planned floor construction, generally comprising thermal insulation, impact sound insulation, underfloor heating as applicable, screed and covering layer, can then be applied. The length of the lining pipes is designed for a floor construction with a slab-to-floor height of up to 250 mm. For a visually appealing result, for a floor construction < 250 mm, cutting off the projecting lining pipes to the level of the top edge of the finished floor is recommended. This can be done before or after preparing the floor construction.



Installation of end caps/ insertion of media lines

The end caps are pushed onto the cable conduits at the transition point and the media lines are inserted.

Solo end cap: 1 media line 4-40 mm

Duo end cap: 2 media lines each 4-25 mm

The end caps are secured both to the cable conduit and the media line using the supplied clamps.



Installation of the MHC gasket insert

Finally, the MHC gasket inserts are installed from the inside of the structure:

MHC Solo gasket insert: 1 media line 4-40 mm

MHC Multi gasket insert:
up to 2 media lines 2 x 4-25 mm + 2 x 10 mm

You will find detailed installation instructions for adapting to the media line on page 124, and for installation of the gasket insert on page 126.

Lining pipes

Pressure water-tight recess pipes for installation flush with formwork

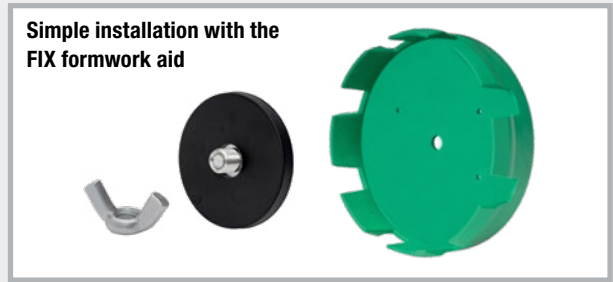

UniCut lining pipe page 111



FASO lining pipes pages 112 – 114



WELLO active lining pipe page 115



DURO Plus High-pressure lining pipe page 116



MKD cable bushing page 117



STEELO lining pipe Lining pipe accessories MASTERTEC Connector closure plug + connection seal page 118

For the subsequent, professional introduction of pipes and lines into buildings, the use of lining pipes is essential. The components are manufactured for the corresponding wall thickness, enable installation flush with the formwork and form a pressure water-tight bond with the surrounding concrete component.

They leave a circular recess with a smooth surface in the wall, into which pipes and cables can subsequently be fed and sealed with MASTER-Ring gasket inserts or MASTER-SEAL modular seals.

UniCut lining pipe

NEW! The lining pipe for stock keeping.
24 installation options with 3 products

- Suitable for wall thickness 200 to 500 mm
- Easy on-site cutting on saw groove or in fixed length
- Pressure water-tight “Novo” waterstop
- Trowel flange for the connection of the outer seal
- Suitable for gasket inserts and modular seals
- Supplied with 2 closure plugs



Supplied with 2 closure plugs

Art.Gr.
430

Dimensions

Art. no.	Description	Wall thickness/ length mm	PU	Weight per pc.	Order FIX formwork aid separately
082504	UniCut lining pipe DN 100 Fixed length	200	1 pc.	0.87 kg	
082505	UniCut lining pipe DN 100 Fixed length	240	1 pc.	0.95 kg	
082506	UniCut lining pipe DN 100 Fixed length	250	1 pc.	0.97 kg	
082507	UniCut lining pipe DN 100 Fixed length	300	1 pc.	1.07 kg	
082508	UniCut lining pipe DN 100 Fixed length	350	1 pc.	1.17 kg	
082509	UniCut lining pipe DN 100 Fixed length	365	1 pc.	1.20 kg	
082511	UniCut lining pipe DN 100 Fixed length	400	1 pc.	1.27 kg	
082510	UniCut lining pipe DN 100 Stock length	500	1 pc.	1.42 kg	
082512	UniCut lining pipe DN 150 Fixed length	200	1 pc.	1.10 kg	
082513	UniCut lining pipe DN 150 Fixed length	240	1 pc.	1.22 kg	
082514	UniCut lining pipe DN 150 Fixed length	250	1 pc.	1.25 kg	
082516	UniCut lining pipe DN 150 Fixed length	300	1 pc.	1.40 kg	
082517	UniCut lining pipe DN 150 Fixed length	350	1 pc.	1.55 kg	
082518	UniCut lining pipe DN 150 Fixed length	365	1 pc.	1.59 kg	
082519	UniCut lining pipe DN 150 Fixed length	400	1 pc.	1.70 kg	
082515	UniCut lining pipe DN 150 Stock length	500	1 pc.	1.89 kg	
082521	UniCut lining pipe DN 200 Fixed length	200	1 pc.	1.33 kg	
082522	UniCut lining pipe DN 200 Fixed length	240	1 pc.	1.49 kg	
082523	UniCut lining pipe DN 200 Fixed length	250	1 pc.	1.53 kg	
082524	UniCut lining pipe DN 200 Fixed length	300	1 pc.	1.72 kg	
082525	UniCut lining pipe DN 200 Fixed length	350	1 pc.	1.92 kg	
082526	UniCut lining pipe DN 200 Fixed length	365	1 pc.	1.98 kg	
082527	UniCut lining pipe DN 200 Fixed length	400	1 pc.	2.12 kg	
082520	UniCut lining pipe DN 200 Stock length	500	1 pc.	2.35 kg	



With saw grooves for cutting to length at the construction site



With waterstop



Fastening using the trowel flange

FASO lining pipe



Lining pipe made of fibre cement for lead-through of pipes and cables



- Tested based on the German WU directive for Water-Impermeable Concrete Buildings against pressurised water and non-pressurised water
- The external corrugation joins homogeneously with the concrete and is water-tight. No additional external waterproofing is required.
- Diameter DN 50 to DN 800 immediately available in stock for delivery in all lengths
- Suitable for gasket inserts and modular seals

Special lengths

- Any intermediate lengths can be supplied – we charge the price of the next higher stock length
- DN 50 to DN 800 can be extended up to 1600 mm.
- DN 50 to DN 400 available for delivery with closure plug, please order separately.
- We will inform you whether delivery is to be made by freight forwarder or courier.

FASO inner Ø mm	outer Ø mm	Standard lengths												Order closure plug or FIX formwork aid separately
		200 mm	240 mm	250 mm	300 mm	350 mm	365 mm	400 mm	500 mm	600 mm	800 mm	1000 mm	1200 mm	
DN 50 Weight/pc.	90	080020 1.82 kg	080021 2.18 kg	080022 2.27 kg	080023 2.73 kg	080024 3.18 kg	080025 3.32 kg	080026 3.64 kg	080027 4.55 kg	080028 5.46 kg	080029 7.27 kg	080030 9.09 kg	080031 10.91 kg	
DN 80 Weight/pc.	120	080210 2.58 kg	080211 3.09 kg	080212 3.22 kg	080213 3.86 kg	080214 4.51 kg	080215 4.70 kg	080216 5.15 kg	080217 6.44 kg	080218 7.73 kg	080918 10.30 kg	080950 12.88 kg	080219 15.46 kg	
DN 100 Weight/pc.	140	080220 3.39 kg	080221 4.07 kg	080222 4.24 kg	080223 5.09 kg	080224 5.94 kg	080225 6.19 kg	080226 6.78 kg	080227 8.48 kg	080228 10.18 kg	080921 13.33 kg	080952 16.96 kg	080229 20.35 kg	
DN 125 Weight/pc.	165	080230 3.81 kg	080231 4.57 kg	080232 4.76 kg	080233 5.71 kg	080234 6.66 kg	080235 6.95 kg	080236 7.62 kg	080237 9.52 kg	080238 11.42 kg	080922 15.45 kg	080954 19.04 kg	080239 22.85 kg	
DN 150 Weight/pc.	190	080240 4.32 kg	080241 5.18 kg	080242 5.40 kg	080243 6.48 kg	080244 7.56 kg	080245 7.88 kg	080246 8.64 kg	080247 10.80 kg	080248 12.96 kg	080924 17.27 kg	080956 21.59 kg	080249 25.91 kg	
DN 200 Weight/pc.	250	080250 7.18 kg	080251 8.62 kg	080252 8.98 kg	080253 10.78 kg	080254 12.57 kg	080255 13.11 kg	080256 14.37 kg	080257 17.96 kg	080258 21.55 kg	080926 28.74 kg	080958 35.92 kg	080259 43.10 kg	
DN 250 Weight/pc.	300	080260 8.94 kg	080261 10.73 kg	080262 11.17 kg	080263 13.41 kg	080264 15.64 kg	080265 16.31 kg	080266 17.88 kg	080267 22.35 kg	080268 26.82 kg	080928 35.76 kg	080960 44.70 kg	080269 53.64 kg	
DN 300 Weight/pc.	350	080270 10.07 kg	080271 12.09 kg	080272 12.59 kg	080273 15.11 kg	080274 17.63 kg	080275 18.38 kg	080276 20.14 kg	080277 25.18 kg	080278 30.22 kg	080930 40.29 kg	080962 50.36 kg	080279 60.43 kg	
DN 350 Weight/pc.	400	080280 11.59 kg	080281 13.91 kg	080282 14.49 kg	080283 17.39 kg	080284 20.28 kg	080285 21.15 kg	080286 23.18 kg	080287 28.98 kg	080288 34.77 kg	080932 46.36 kg	080964 57.96 kg	080289 69.55 kg	
DN 400 Weight/pc.	460	080290 15.76 kg	080291 18.91 kg	080292 19.70 kg	080293 23.64 kg	080294 27.58 kg	080295 28.77 kg	080296 31.52 kg	080297 39.41 kg	080298 47.29 kg	080934 63.05 kg	080966 78.81 kg	080299 94.57 kg	
DN 450 Weight/pc.	510	080300 18.08 kg	080301 21.70 kg	080302 22.60 kg	080303 27.12 kg	080304 31.64 kg	080305 33.00 kg	080306 36.16 kg	080307 45.20 kg	080308 54.24 kg	080936 72.33 kg	080968 90.41 kg	080309 108.49 kg	No closure plug available DN 450 – DN 800
DN 500 Weight/pc.	570	080310 23.70 kg	080311 28.44 kg	080312 29.63 kg	080313 35.56 kg	080314 41.48 kg	080315 43.26 kg	080316 47.41 kg	080317 59.26 kg	080318 71.11 kg	080938 94.82 kg	080970 118.52 kg	080319 142.22 kg	
DN 600 Weight/pc.	670	080320 28.32 kg	080321 33.98 kg	080322 35.39 kg	080323 42.47 kg	080324 49.55 kg	080325 51.67 kg	080326 56.63 kg	080327 70.79 kg	080328 84.94 kg	080940 113.26 kg	080972 141.57 kg	080329 169.88 kg	
DN 700 Weight/pc.	780	080330 38.22 kg	080331 45.86 kg	080332 47.77 kg	080333 57.32 kg	080334 66.88 kg	080335 69.74 kg	080336 76.43 kg	080337 95.54 kg	080338 114.65 kg	080942 152.86 kg	080974 191.08 kg	080339 229.29 kg	
DN 800 Weight/pc.	880	080340 42.17 kg	080341 50.61 kg	080342 52.72 kg	080343 63.26 kg	080344 73.80 kg	080345 76.96 kg	080346 84.35 kg	080347 105.43 kg	080348 126.52 kg	080944 168.69 kg	080976 210.86 kg	080349 253.03 kg	

FASO lining pipe, **split**

NEW!
split

When media lines have already been laid, the split version FASO lining pipes can be installed and bonded afterwards.

- Against pressurised and non-pressurised water
- Diameters DN 50 to DN 400 available for immediate delivery



FASO split inner Ø mm	outer Ø mm	Standard lengths										
		200 mm	240 mm	250 mm	300 mm	350 mm	365 mm	400 mm	500 mm	600 mm	800 mm	1000 mm
DN 50 Weight/pc.	90	080020T 1.82 kg	080021T 2.18 kg	080022T 2.27 kg	080023T 2.73 kg	080024T 3.18 kg	080025T 3.32 kg	080026T 3.64 kg	080027T 4.55 kg	080028T 5.46 kg	080029T 7.27 kg	080030T 9.09 kg
DN 80 Weight/pc.	120	080210T 2.58 kg	080211T 3.09 kg	080212T 3.22 kg	080213T 3.86 kg	080214T 4.51 kg	080215T 4.70 kg	080216T 5.15 kg	080217T 6.44 kg	080218T 7.73 kg	080918T 10.30 kg	080950T 12.88 kg
DN 100 Weight/pc.	140	080220T 3.39 kg	080221T 4.07 kg	080222T 4.24 kg	080223T 5.09 kg	080224T 5.94 kg	080225T 6.19 kg	080226T 6.78 kg	080227T 8.48 kg	080228T 10.18 kg	080921T 13.33 kg	080952T 16.96 kg
DN 125 Weight/pc.	165	080230T 3.81 kg	080231T 4.57 kg	080232T 4.76 kg	080233T 5.71 kg	080234T 6.66 kg	080235T 6.95 kg	080236T 7.62 kg	080237T 9.52 kg	080238T 11.42 kg	080922T 15.45 kg	080954T 19.04 kg
DN 150 Weight/pc.	190	080240T 4.32 kg	080241T 5.18 kg	080242T 5.40 kg	080243T 6.48 kg	080244T 7.56 kg	080245T 7.88 kg	080246T 8.64 kg	080247T 10.80 kg	080248T 12.96 kg	080924T 17.27 kg	080956T 21.59 kg
DN 200 Weight/pc.	250	080250T 7.18 kg	080251T 8.62 kg	080252T 8.98 kg	080253T 10.78 kg	080254T 12.57 kg	080255T 13.11 kg	080256T 14.37 kg	080257T 17.96 kg	080258T 21.55 kg	080926T 28.74 kg	080958T 35.92 kg
DN 250 Weight/pc.	300	080260T 8.94 kg	080261T 10.73 kg	080262T 11.17 kg	080263T 13.41 kg	080264T 15.64 kg	080265T 16.31 kg	080266T 17.88 kg	080267T 22.35 kg	080268T 26.82 kg	080928T 35.76 kg	080960T 44.70 kg
DN 300 Weight/pc.	350	080270T 10.07 kg	080271T 12.09 kg	080272T 12.59 kg	080273T 15.11 kg	080274T 17.63 kg	080275T 18.38 kg	080276T 20.14 kg	080277T 25.18 kg	080278T 30.22 kg	080930T 40.29 kg	080962T 50.36 kg
DN 350 Weight/pc.	400	080280T 11.59 kg	080281T 13.91 kg	080282T 14.49 kg	080283T 17.39 kg	080284T 20.28 kg	080285T 21.15 kg	080286T 23.18 kg	080287T 28.98 kg	080288T 34.77 kg	080932T 46.36 kg	080964T 57.96 kg
DN 400 Weight/pc.	460	080290T 15.76 kg	080291T 18.91 kg	080292T 19.70 kg	080293T 23.64 kg	080294T 27.58 kg	080295T 28.77 kg	080296T 31.52 kg	080297T 39.41 kg	080298T 47.29 kg	080934T 63.05 kg	080966T 78.81 kg



1. Place the supplied spacers on the cut edge of the lower shell and apply PROTECT Easy 1K (art. no. 040030) on the cut edges (usage: approx. 150 g/m on both sides). The PROTECT Easy 1K concrete adhesive must be ordered separately.



2. Fit the upper shell and press it on so that the adhesive is pressed out of the joint. In the process, you must make sure that the spacers remain in position. Smooth the joints inside the lining pipe in order to achieve a clean surface for possible installation of a gasket insert.



PROTECT Easy 1K (art. no. 040030)
Single-component polymer-based concrete adhesive
For water-tight bonding of all fibre cement distance tubes and fibre cement lining pipes.
You will find the adhesive on page 94 in our complete catalogue.

FASO lining pipe

NEW! with installed flange



- Against pressurised and non-pressurised water
- With adhesive flange according to DIN 18533
- Can be used in conjunction with the following waterproofing materials:
 - Thick coating
 - All common types of external waterproofing
 - Waterproofing slurries
 - Connection of fresh concrete compound foil (FBV) using liquid plastic

FASO inner Ø mm	Flange dimensions: Outer diameter x thickness	Flange projection mm	Standard lengths									Order closure plug or FIX formwork aid separately
			200 mm	240 mm	250 mm	300 mm	350 mm	365 mm	400 mm	500 mm	600 mm	
DN 50 Weight/pc.	250 x 12.5 mm	100	080020F 2.42 kg	080021F 2.78 kg	080022F 2.87 kg	080023F 3.33 kg	080024F 3.78 kg	080025F 3.92 kg	080026F 4.24 kg	080027F 5.15 kg	080028F 6.06 kg	
DN 80 Weight/pc.	250 x 12.5 mm	85	080210F 3.13 kg	080211F 3.64 kg	080212F 3.77 kg	080213F 4.41 kg	080214F 5.06 kg	080215F 5.25 kg	080216F 5.70 kg	080217F 6.99 kg	080218F 8.28 kg	
DN 100 Weight/pc.	300 x 12.5 mm	100	080220F 4.19 kg	080221F 4.87 kg	080222F 5.04 kg	080223F 5.89 kg	080224F 6.74 kg	080225F 6.99 kg	080226F 7.58 kg	080227F 9.28 kg	080228F 10.98 kg	
DN 125 Weight/pc.	325 x 12.5 mm	100	080230F 4.71 kg	080231F 5.47 kg	080232F 5.66 kg	080233F 6.61 kg	080234F 7.56 kg	080235F 7.85 kg	080236F 8.52 kg	080237F 10.42 kg	080238F 12.32 kg	
DN 150 Weight/pc.	350 x 12.5 mm	100	080240F 5.32 kg	080241F 6.18 kg	080242F 6.40 kg	080243F 7.48 kg	080244F 8.56 kg	080245F 8.88 kg	080246F 9.64 kg	080247F 11.80 kg	080248F 13.96 kg	
DN 200 Weight/pc.	400 x 12.5 mm	100	080250F 8.38 kg	080251F 9.82 kg	080252F 10.18 kg	080253F 11.98 kg	080254F 13.77 kg	080255F 14.31 kg	080256F 15.57 kg	080257F 19.16 kg	080258F 22.75 kg	
DN 250 Weight/pc.	450 x 12.5 mm	100	080260F 10.34 kg	080261F 12.13 kg	080262F 12.57 kg	080263F 14.81 kg	080264F 17.04 kg	080265F 17.71 kg	080266F 19.28 kg	080267F 23.75 kg	080268F 28.22 kg	
DN 300 Weight/pc.	500 x 12.5 mm	100	080270F 11.67 kg	080271F 13.69 kg	080272F 14.19 kg	080273F 16.71 kg	080274F 19.23 kg	080275F 19.98 kg	080276F 21.74 kg	080277F 26.78 kg	080278F 31.82 kg	

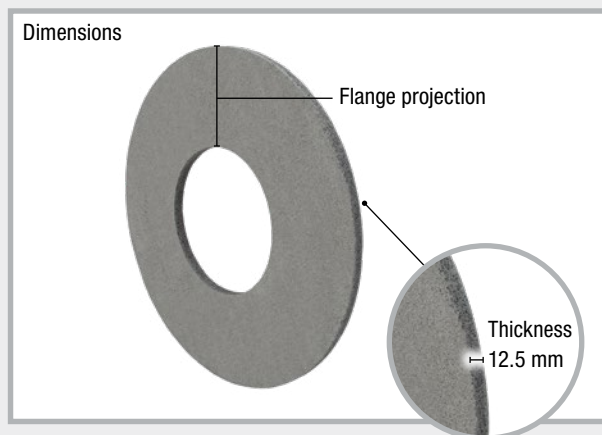
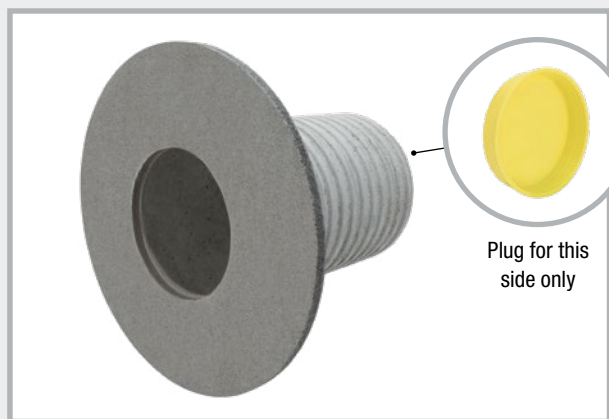

The flange is applied to the desired lining pipe on our premises.

WELLO active lining pipe

Art.Gr.
404

When the use of sealing collars is not possible, lining pipes are installed, which enable the subsequent water-tight lead-through of the medium pipe into the building.

The cost-efficient PE lining pipe is available at short notice ex stock in dia. 100 to 400 mm. Its inner surface is smooth. The corrugated outside ensures a firm bond with the concrete. Two swelling tapes applied centrally around the lining pipe act as waterstops.



Tested for impermeability up to 20 m water column

WELLO inner Ø mm	Standard lengths									Order closure plug or FIX formwork aid separately
	200 mm	240 mm	250 mm	300 mm	350 mm	365 mm	400 mm	500 mm	600 mm	
DN 100 Weight/pc.	080130 0.17 kg	080131 0.19 kg	080132 0.20 kg	080133 0.23 kg	080134 0.26 kg	080135 0.26 kg	080136 0.28 kg	080137 0.34 kg	080138 0.40 kg	
DN 125 Weight/pc.	080140 0.26 kg	080141 0.30 kg	080142 0.31 kg	080143 0.36 kg	080144 0.41 kg	080145 0.42 kg	080146 0.46 kg	080147 0.56 kg	080148 0.65 kg	
DN 150 Weight/pc.	080150 0.29 kg	080151 0.33 kg	080152 0.35 kg	080153 0.40 kg	080154 0.45 kg	080155 0.47 kg	080156 0.51 kg	080157 0.62 kg	080158 0.72 kg	
DN 200 Weight/pc.	080160 0.57 kg	080161 0.66 kg	080162 0.68 kg	080163 0.80 kg	080164 0.92 kg	080165 0.95 kg	080166 1.03 kg	080167 1.27 kg	080168 1.50 kg	
*DN 250 Weight/pc.	080170 0.86 kg	080171 1.01 kg	080172 1.04 kg	080173 1.23 kg	080174 1.41 kg	080175 1.46 kg	080176 1.59 kg	080177 1.96 kg	080178 2.33 kg	
DN 300 Weight/pc.	080180 1.20 kg	080181 1.41 kg	080182 1.46 kg	080183 1.72 kg	080184 1.99 kg	080185 2.06 kg	080186 2.25 kg	080187 2.77 kg	080188 3.30 kg	
*DN 350 Weight/pc.	080190 1.67 kg	080191 1.97 kg	080192 2.05 kg	080193 2.42 kg	080194 2.80 kg	080195 2.91 kg	080196 3.17 kg	080197 3.92 kg	080198 4.67 kg	
DN 400 Weight/pc.	080200 2.10 kg	080201 2.48 kg	080202 2.57 kg	080203 3.04 kg	080204 3.52 kg	080205 3.66 kg	080206 3.99 kg	080207 4.94 kg	080208 5.89 kg	

Special lengths: Any intermediate lengths can be supplied.
Maximum length of lining pipe: 2000 mm

* DN 250 + DN 350 waterproofing with modular seal only

We recommend installation with closure plugs

DURO Plus

high-pressure lining pipe

 Art.Gr.
403

DURO Plus are high pressure-resistant lining pipes for secure and permanent routing of pipes and cables in buildings. A sealing collar which can withstand water pressures of up to a 70 m water column is fitted to the lining pipes at the factory and provides reliable protection from radon penetration.

The diameters DN 50 to DN 300 are available within a few days. When ordering, please state whether you require the lining pipes with or without plugs.



DURO inner Ø mm	Ø Outside mm	Standard lengths												Order clo- sure plug or FIX formwork aid separately
		200 mm	240 mm	250 mm	300 mm	350 mm	365 mm	400 mm	500 mm	600 mm	800 mm	1000 mm	1200 mm	
DN 50 Weight/pc.	54	090010 0.35 kg	090013 0.37 kg	090016 0.38 kg	090019 0.40 kg	090022 0.42 kg	090025 0.43 kg	090028 0.45 kg	090031 0.49 kg	090034 0.54 kg	090037 0.63 kg	090040 0.73 kg	090043 0.82 kg	
DN 80 Weight/pc.	85	090050 0.31 kg	090053 0.35 kg	090056 0.36 kg	090059 0.41 kg	090062 0.46 kg	090065 0.47 kg	090068 0.51 kg	090071 0.60 kg	090074 0.70 kg	090077 0.89 kg	090080 1.09 kg	090083 1.28 kg	
DN 100 Weight/pc.	110	090110 0.67 kg	090113 0.76 kg	090116 0.79 kg	090119 0.91 kg	090122 1.04 kg	090125 1.07 kg	090128 1.16 kg	090131 1.41 kg	090134 1.65 kg	090137 2.15 kg	090140 2.64 kg	090143 3.13 kg	
DN 125 Weight/pc.	137	090150 0.78 kg	090153 0.90 kg	090156 0.93 kg	090159 1.08 kg	090162 1.23 kg	090165 1.27 kg	090168 1.38 kg	090171 1.67 kg	090174 1.97 kg	090177 2.56 kg	090180 3.16 kg	090183 3.75 kg	
DN 150 Weight/pc.	162	090210 0.91 kg	090213 1.05 kg	090216 1.08 kg	090219 1.26 kg	090222 1.44 kg	090225 1.49 kg	090228 1.61 kg	090231 1.97 kg	090234 2.32 kg	090237 3.03 kg	090240 3.73 kg	090243 4.44 kg	
DN 200 Weight/pc.	214	090250 1.44 kg	090253 1.68 kg	090256 1.74 kg	090259 2.03 kg	090262 2.32 kg	090265 2.41 kg	090268 2.62 kg	090271 3.20 kg	090274 3.79 kg	090277 4.96 kg	090280 6.14 kg	090283 7.31 kg	
DN 250 Weight/pc.	264	090310 1.71 kg	090313 2.00 kg	090316 2.07 kg	090319 2.42 kg	090322 2.77 kg	090325 2.88 kg	090328 3.13 kg	090331 3.83 kg	090334 4.54 kg	090337 5.95 kg	090340 7.37 kg	090343 8.78 kg	
DN 300 Weight/pc.	316	090350 2.57 kg	090353 3.00 kg	090356 3.11 kg	090359 3.66 kg	090362 4.21 kg	090365 4.37 kg	090368 4.75 kg	090371 5.85 kg	090374 6.94 kg	090377 9.13 kg	090380 11.31 kg	090383 13.50 kg	

Special lengths: Any intermediate lengths can be supplied.
Lengths up to 3000 mm are available.

We recommend installation with closure plugs



Production possible according to your individual specifications

MASTERTEC

MKD 150 cable bushing



Stay flexible with the MKD 150 cable bushing

The MKD 150 cable bushing is manufactured in the corresponding wall thickness and consists of 2 seal fittings, a factory-installed high-pressure waterstop and a closure plug which is pressure-tight up to a water column of 30 m. The bayonet connections are compatible with all standard systems.

- Flexible connection of cables in new buildings
- Sealing with RONDO Base sealing collar
- Stable design due to solid wall material
- Compatible with all standard systems

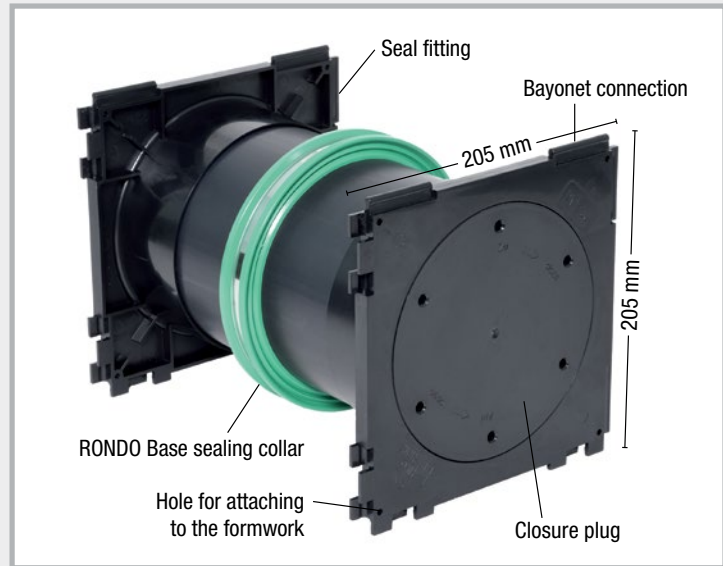

We recommend using gasket inserts for the waterproofing.
You can achieve maximum pressure resistance using this system.

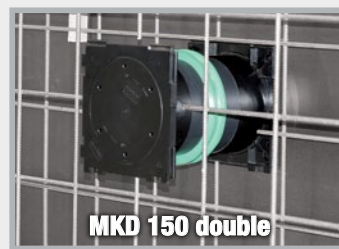

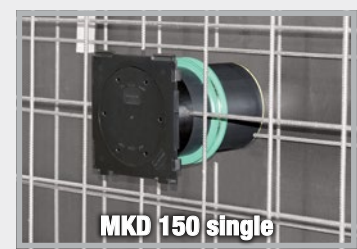

Seal fitting on both sides



Seal fitting on one side; closure plug on the other side

Product range

Art.Gr.
411

MKD 150 – double version				MKD 150 – single version			
Art. no.	Wall thickness	PU	Weight per pc.	Art. no.	Wall thickness	PU	Weight per pc.
162410	180 mm	1 pc.	1.30 kg	162460	180 mm	1 pc.	1.10 kg
162415	200 mm	1 pc.	1.40 kg	162465	200 mm	1 pc.	1.20 kg
162420	240 mm	1 pc.	1.50 kg	162470	240 mm	1 pc.	1.30 kg
162425	250 mm	1 pc.	1.60 kg	162475	250 mm	1 pc.	1.40 kg
162430	300 mm	1 pc.	1.70 kg	162480	300 mm	1 pc.	1.50 kg
162435	350 mm	1 pc.	1.90 kg	162485	350 mm	1 pc.	1.70 kg
162440	365 mm	1 pc.	1.95 kg	162490	365 mm	1 pc.	1.80 kg
162445	400 mm	1 pc.	2.10 kg	162495	400 mm	1 pc.	1.90 kg
162400	Key for opening the closure plug						

Other wall thicknesses are available on request

MASTER-RING gasket inserts are available on request. You will need to let us know the outer diameters of the cables and pipes to be led through.

STEELO stainless steel lining pipe

with watertight centre flange against pressurised and non-pressurised water

STEELO lining pipes are manufactured from V2A or V4A stainless steel. The centre flange is welded watertight.

■ Very good chemical and thermal resistance



Art.Gr. 406

STEELO V2A lining pipe available on request

STEELO inner Ø mm	Dimensions						
	200 mm	240 mm	250 mm	300 mm	350 mm	365 mm	400 mm
DN 80	081200	081240	081250	081300	081350	081365	081400
DN 100	082200	082240	082250	082300	082350	082365	082400
DN 125	083200	083240	083250	083300	083350	083365	083400
DN 150	084200	084240	084250	084300	084350	084365	084400
DN 200	085200	085240	085250	085300	085350	085365	085400
DN 250	086200	086240	086250	086300	086350	086365	086400
DN 300	087200	087240	087250	087300	087350	087365	087400

Version V4A = on request

Accessories for lining pipes Closure plug + installation aid for lining pipes

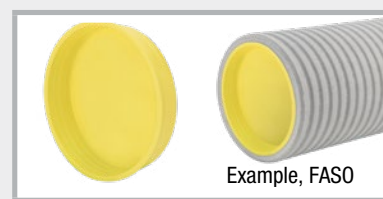

Art.Gr. 452

Example, FASO

	Diameter mm									
	50	80	100	125	150	200	250	300	350	400
Art. no.	090403	090401	090400	090402	090404	090406	090408	090410	090412	090414
Weight/pc.	0.005 kg	0.02 kg	0.02 kg	0.03 kg	0.05 kg	0.08 kg	0.12 kg	0.13 kg	0.40 kg	0.45 kg

Sewage socket ring for sewage pipe bushings Flow direction type

Art.Gr. 451

Art. no.	Type	PU	Weight/pc.
080476	MFR 110	1 pc.	0.05 kg
080477	MFR 125	1 pc.	0.06 kg
080478	MFR 160	1 pc.	0.08 kg
080479	MFR 200	1 pc.	0.13 kg



Socket ring on DL 110/500

Foil flange dim. 50 x 50 cm for lining pipes incl. mounting strap

Art.Gr. 453

	Lining pipe diameter in mm					
	50	80	100	125	150	200
Art. no.	090388	090389	090390	090391	090392	090393
Weight/pc.	0.19 kg	0.20 kg	0.43 kg	0.45 kg	0.47 kg	0.70 kg

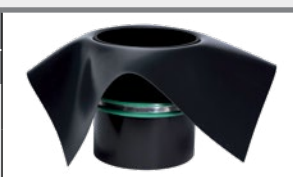

For fixing the foil flange to the component, we recommend the **POWER** swelling tape adhesive.

Foil flange made of 1.5 mm PVC foil, resistant to oil and bitumen, weldable with hot air gun, bondable with solvent welding agent

1 SWELLING TAPES
2 JOINT SHEET METALS
3 INJECTION HOSES CONSTRUCTION CHEMISTRY
4 SERVICE DUCTS
5 LIGHTNING PROTECTION
6 FORMWORK ACCESSORIES

MASTERTEC Connector



Connection seal

With the MASTERTEC Connector connection seal, corrugated cable conduits (corrugated pipes) or sewage pipes can be professionally connected to core drill holes or lining pipes.

- Pressure water-tight: Corrugated pipe: up to 10 m water column
KG pipe (sewage pipe): up to 20 m water column
- Easy installation
- Adapted to common corrugated pipe outer diameters and sewage pipe Ø 110 mm



Dimensions

Art.Gr.
431

Art. no.	Type	Ø lining pipe/ core drill hole	Ø connection pipe	PU	Weight per pc.
090850	MC 100 / 75W	100 mm	Corrugated pipe Ø 75 mm	1 pc.	0.57 kg
090852	MC 150 / 90W	150 mm	Corrugated pipe Ø 90 mm	1 pc.	1.01 kg
090854	MC 150 / 110W	150 mm	Corrugated pipe Ø 110 mm	1 pc.	0.91 kg
090856	MC 150 / 110 KG	150 mm	Sewage pipe Ø 110 mm	1 pc.	0.88 kg

Installation with corrugated pipe

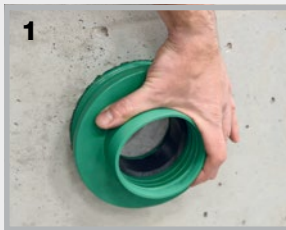

1. The connection seal is positioned in the core drill hole/lining pipe, ...

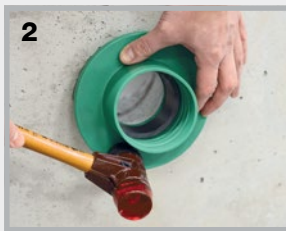

2. ... completely hammered in with a rubber mallet, ...

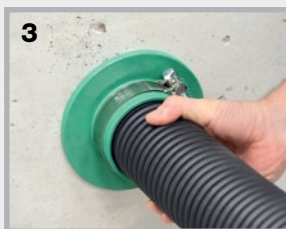

3. ... the clamp is placed over the connection seal and the connection pipe pushed in as far as it will go, ...

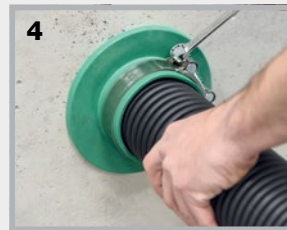

4. ... the clamp is hand-tightened with a ring spanner, ...

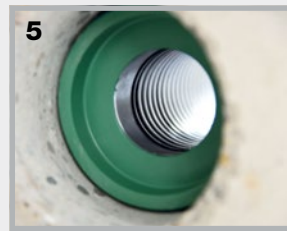

5. ... the cable conduit is connected to the core drill hole or the lining pipe and is pressure water-tight.

Installation with sewage pipe

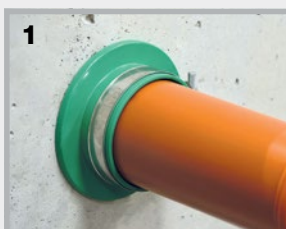

1. The installation is the same as for the cable conduit, ...



2. ... the sewage pipe is pushed completely through the seal and the clamp is hand-tightened with a ring spanner.

Gasket inserts, modular seals + FLEX 2000

1 SWELLING TAPES
2 JOINT SHEET METALS
3 INJECTION HOSES CONSTRUCTION CHEMISTRY
4 SERVICE DUCTS
5 LIGHTNING PROTECTION
6 FORMWORK ACCESSORIES



MASTER-RING
Gasket insert

page 121



MASTER-RING Supersoft

page 122



MASTER-RING blind plug

page 122



MASTER-RING Multi

pages 123 – 124



MASTER-RING Multi Multiple

page 125



MASTER-RING Multiple

page 126



FLEX 2000

page 127



MASTER-SEAL
Modular seal

pages 128 – 129

MASTER-RING



Stainless steel V2A gasket inserts

Gasket inserts for lining pipes and core drill holes

- One seal against pressurised and non-pressurised water
- Pressure-tight up to 30 m water column, in fixed and secure position up to 50 m
- Rubber thickness 40 mm
- Steel parts and screws made of V2A stainless steel
- Satisfy the requirements of the FHRK testing principles GE 101



Installation: Once the gasket insert has been inserted and the medium pipe has been led through, the screws are tightened crosswise. Give each screw one turn and repeat this procedure several times so the rubber is pressed out uniformly. Maximum torque M6 = 5 Nm, M8 = 10 Nm, M10 = 15 Nm, M12 = 20 Nm. Retighten the nuts after 1-2 hours.

Ø lining pipe/ core drill hole	Medium pipe in mm		Weight per pc.	Closed version	Art.Gr. 440	Split version	Art.Gr. 441
	from	to		Art. no.	Art. no.		
50	6	12	0.19 kg	120080			
80	20	28	0.39 kg	120100			
80	32	40	0.36 kg	120105			
80	48	50	0.32 kg	120095			
100	15	22	0.58 kg	120107			
100	20	28	0.60 kg	120110			
100	25	32	0.60 kg	120112			
100	32	40	0.58 kg	120115			
100	36	44	0.56 kg	120120			
100	46	56	0.48 kg	120125		120125T	
100	55	65	0.51 kg	120130			
125	55	64	0.74 kg	120145			
125	70	78	0.67 kg	120150			
150	46	54	1.53 kg	120152			
150	56	66	1.31 kg	120153			
150	69	78	1.24 kg	120155			
150	79	91	1.17 kg	120160			
150	85	94	1.07 kg	120165			
150	98	110	0.96 kg	120170		120170T	
200	88	103	2.13 kg	120172			
200	108	115	2.03 kg	120175		120175T	
200	116	126	1.91 kg	120180		120180T	
200	132	141	1.51 kg	120185			
200	135	144	1.48 kg	120190			
200	150	160	1.41 kg	120192		120192T	
250	135	144	2.86 kg	120195			
250	140	149	3.02 kg	120197			
250	150	159	2.69 kg	120200			
250	157	162	2.65 kg	120205		120205T	
250	174	181	2.24 kg	120210			
250	178	187	2.16 kg	120215			
250	197	202	1.84 kg	120216		120216T	
250	204	210	1.77 kg	120218			
300	193	204	3.49 kg	120225			
300	218	226	3.17 kg	120230			
350	224	233	5.44 kg	120235			
350	249	258	4.98 kg	120240			
350	270	282	3.64 kg	120242			
400	270	280	6.14 kg	120245			
400	279	288	6.06 kg	120250			
400	304	313	5.47 kg	120255			
400	314	323	4.57 kg	120260			
400	320	330	4.44 kg	120265			

Additional supply options: Steel parts + screws in V4A stainless steel; rubber made of NBR or compliant with potable water quality standards available on request

MASTER-RING Supersoft

Gasket insert for corrugated and thin-walled medium pipes

- Pressure-tight up to 10 m water column
- Soft rubber compound for corrugated and thin-walled medium pipes
- Rubber thickness 2 x 40 mm
- Steel parts and screws made of V2A stainless steel



Art.Gr.
437

Core drill hole mm Lining pipe FASO/ WELLO/DURO Plus	Art. no.	Medium pipe in mm		PU	Weight per pc.
		from	to		
100	120280	46	56	1 pc.	0.73 kg
100	120282	55	65	1 pc.	0.72 kg
150	120284	69	78	1 pc.	1.88 kg
150	120286	85	94	1 pc.	1.57 kg
150	120288	98	110	1 pc.	1.32 kg
200	120290	108	115	1 pc.	3.04 kg
200	120292	119	128	1 pc.	2.52 kg
200	120294	150	160	1 pc.	1.95 kg
250	120296	156	165	1 pc.	3.70 kg

Stainless steel V2A blind plugs

for core drill hole and lining pipe

- Pressure-tight up to 15 m water column
- Rubber thickness 40 mm
- Steel parts and screws made of V2A stainless steel

Art.Gr.
438

DN	Art. no.	PU	Weight per pc.
50	120518	1 pc.	0.20 kg
80	120520	1 pc.	0.49 kg
100	120525	1 pc.	0.75 kg
125	120530	1 pc.	1.15 kg
150	120535	1 pc.	2.17 kg
200	120540	1 pc.	3.40 kg
250	120545	1 pc.	5.91 kg
300	120550	1 pc.	8.47 kg

Blind plugs up to DN 1500 mm available on request



MASTER-RING Multi

Gasket inserts with "onion ring" technology



A large number of installation options with only 4 sizes

- Pressure-resistant: 30 metre water column for closed version
7.5 metre water column for split version
- Pressure plate material: V2A stainless steel
- Screws and nuts: V2A stainless steel
- Rubber material: EPDM
- Width of rubber: 40 mm
- Resistances: Excellent resistance to ageing, weathering and ozone



Art.Gr. 442				
	MASTER-RING Multi 100 closed Art. no. 120135	MASTER-RING Multi 150 closed Art. no. 120171	MASTER-RING Multi 200 closed Art. no. 120193	MASTER-RING Multi 250 closed Art. no. 120222
Weight/pc.	0.61 kg	1.32 kg	1.73 kg	2.52 kg

Art.Gr. 443				
	NEW! MASTER-RING Multi 100 split Art. no. 120135T	NEW! MASTER-RING Multi 150 split Art. no. 120171T	NEW! MASTER-RING Multi 200 split Art. no. 120193T	NEW! MASTER-RING Multi 250 split Art. no. 120222T
Weight/pc.	0.61 kg	1.32 kg	1.73 kg	2.52 kg

Without inner plug	Medium pipe in mm from to 18-20 mm	Medium pipe in mm from to 62-64 mm	Medium pipe in mm from to 108-110 mm	Medium pipe in mm from to 158-160 mm
1. ring	21-25 mm	74-76 mm	123-125 mm	168-170 mm
2. ring	26-30 mm	88-90 mm	138-140 mm	178-180 mm
3. ring	31-35 mm	108-110 mm	158-160 mm	198-200 mm
4. ring	36-40 mm			208-210 mm
5. ring	41-45 mm			
6. ring	46-50 mm			
7. ring	51-55 mm			
8. ring	56-60 mm			
9. ring	61-65 mm			

Installation of MASTER-RING Multi

Once you have determined the outer diameter of the pipe to be waterproofed, prepare the MASTER-RING Multi for installation.

Example: Multi 100

Example: core drill hole DN 100 and medium pipe with 18 mm outer diameter



Only remove the inner plug.

Example: core drill hole DN 100 and medium pipe with 23 mm outer diameter



After removing the inner plug, release the first ring ...



... and push it through the gasket insert.



Pushed-through 1st ring



Simply cut off the pushed-through ring using a cutter.



Multi 100 ready for installation

Example: Multi 200

Example: core drill hole DN 200 and medium pipe with 110 mm outer diameter



Only remove the inner plug.

Example: core drill hole DN 200 and medium pipe with 125 mm outer diameter



Release the first ring and push it through the gasket.



Cut off the pushed-through ring using a cutter – the gasket is now ready for installation.

Protection of the core drill hole with epoxy resin

- With MC-Injekt 1264 compact, you preserve the core drill hole permanently.
- Application on dry substrate



MASTER-RING Multi Multiple

Steel parts: V2A stainless steel
Version: split
Rubber material: EPDM
Width of rubber: 40 mm
Resistances: Excellent resistance to ageing, weathering and ozone



Art.Gr.
444

Ø lining pipe / core drill hole	Art. no.	Media area				Weight per pc.
		Quantity "Onion ring" elements	Ø /mm	Quantity "Onion ring" elements	Ø /mm	
100	120270	3	4-32			0.82 kg
100	120272	2	4-32	2	4-25	0.78 kg
150	120274	3	22-54			1.70 kg
150	120276	6	4-32			1.86 kg
150	120278	2	4-32	2	22-54	1.72 kg

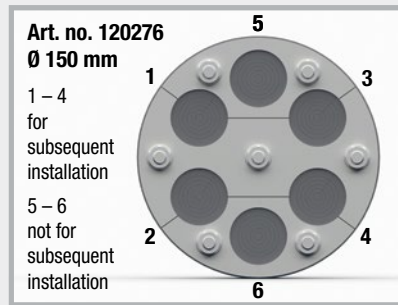
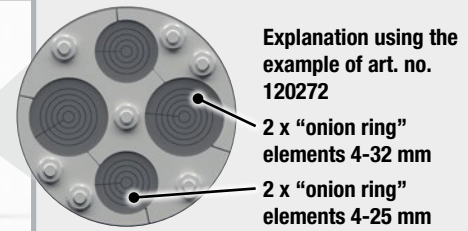

Installation of Multi Multiple

Example for DN 100 core drill hole and medium pipe outer diameter 15 mm with art. no. 120270



Open the split gasket insert and take out the required segmented plug.



Pull out the ring segment you want to remove and sever it with a cutter.



After cutting the stopper to the required size, reinsert it and the gasket insert can be installed.

MASTER-RING Multiple

V2A stainless steel multiple wall duct gasket inserts for cables and pipes

- Pressure-tight up to 10 m water column
- Rubber thickness 40 mm
- Steel parts and screws made of V2A stainless steel

Art.Gr.
439



Split version



Mounted

Core drill hole Lining pipe FASO / WELLO / DURO Plus	Art. no.	Outer diameter Medium pipe in mm	Weight per pc.
50	120515	4 to 20	0.39 kg
80	120410	4 to 33 or 40 or 42	0.43 kg
100	120415	4 to 33 or 40 or 42 or 50	0.62 kg
125	120420	4 to 33 or 40 or 42 or 50	0.93 kg
150	120425	4 to 33 or 40 or 42 or 50	1.31 kg
	120495	Additional borehole	

As a basic rule, the technical feasibility of the combination of number and diameter of the media in relation to the minimum diameter of the core drill hole or lining pipe must be checked. Please contact our sales office for assistance.

Tightening the MASTER-RING gasket inserts

1. Insert the gasket insert into the lining pipe or the core drill hole.
2. Push the medium pipe through.
3. Tighten the screws crosswise through one turn. Repeat this process until all screws are tightened with the respective torque. Retighten the screws after 1-2 hours.

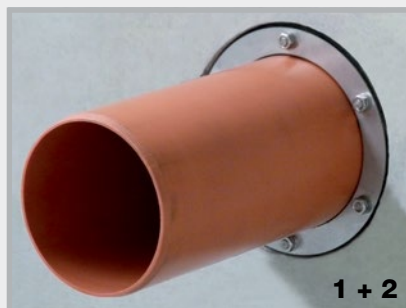

1 + 2

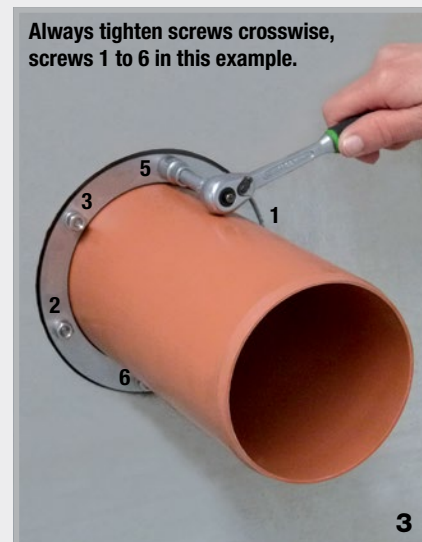

Always tighten screws crosswise, screws 1 to 6 in this example.

3

Nuts	Maximum torque (for dimensionally stable medium pipes)
M6	5 Nm
M8	10 Nm
M10	15 Nm
M12	20 Nm

FLEX 2000



Plastic, vapour and waterproof sealing compound for waterproofing of pipe and cable bushings below ground level. Also suitable for leakage sealing in case of inflowing water.



**Annular gap sealing (tested by MFPA Leipzig)
up to 7.5 m water column**

Art.Gr.
450

Art. no.	Description	PU	Secondary packaging	Weight
120610	FLEX 2000 sealing compound Foil bag 850 g	1 pc.	Carton of 20 foil bags	0.88 kg
120620	Cartridge applicator with flexible nozzle	1 pc.		1.06 kg
120630	Flexible nozzle	1 pc.		0.07 kg



Technical data

Consistency	Paste-like, non-sagging
Heat resistance	+50°C
Processing temperature	+5°C to +35°C
Usage	Approx. 1.6 kg per litre void
Storage	2 years at 20°C

Substrate

The substrate may be dry, damp or wet. The substrate must be free from grease, tar, oil and loose particles. Suitable substrates are: concrete, brick, mortar, plaster and all other mineral construction materials as well as ceramics, PVC, polyethylene and polypropylene.

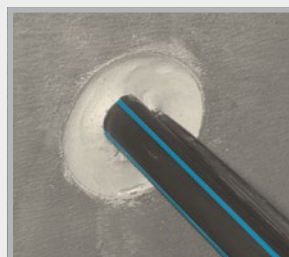
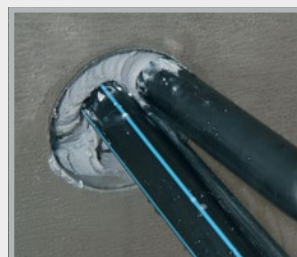
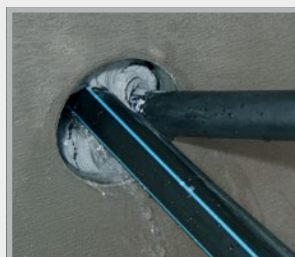

Application

Prior to application, FLEX 2000 is heated to approx. 30-40°C by placing it in warm water for at least 30 minutes to ensure optimum consistency and workability. Clean the inside of the duct using a suitable brush to remove dust, sand, and any loose particles. Before applying FLEX 2000, a securing block of a two-component PUR foam is applied at a depth of approx. 10 cm. The FLEX 2000 foil bag is then placed in the cartridge applicator and the material is pressed through the flexible nozzle into the duct from back to front so that the resulting layer is at least 12 cm thick. After sealing cable bushings, jiggle the cable slightly and press FLEX 2000 into any voids that form. Always ensure that the cable is free of tension and strain after sealing. Finally, the sealing compound set back approx. 1 cm is pressed in well and smoothed with a metal filler knife. As an additional safeguard, the opening of the duct is closed with fast-curing cement. If a new cable is to be installed later on, the mortar barrier is removed and the cable is pushed through the sealing compound. The duct is subsequently sealed using FLEX 2000.

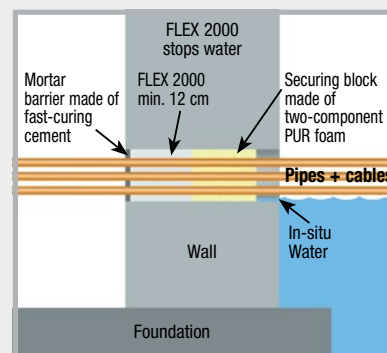

MASTER-SEAL

Modular seal



Art.Gr.
445

- Pre-assembled
- Fast and easy installation
- Tested up to 30 m water column
- Can be retrofitted (all gasket inserts are also separable)

Area of installation of core drill hole in mm Lining pipe FASO / WELLO / DURO Plus	Medium pipe Outer Ø mm		Type	Weight	Stainless steel	Galvanised
	from	to			Art. no.	Art. no.
50	11	19	4 x 275	0.08 kg	110250	110600
50	20	25	4 x 200	0.08 kg	110255	110605
80	20	33	4 x 350	0.32 kg	110260	110610
80	34	44	5 x 300	0.30 kg	110265	110615
80	45	49	6 x 250	0.14 kg	110267	110617
80	50	55	7 x 200	0.14 kg	110268	110618
100	27	38	4 x 375	0.50 kg	110270	110620
100	39	50	6 x 350	0.46 kg	110275	110625
100	56	64	6 x 300	0.36 kg	110280	110630
100	65	69	8 x 250	0.19 kg	110281	110631
100	70	75	9 x 200	0.20 kg	110282	110632
125	41	44	4 x 475	1.04 kg	110283	110633
125	45	52	4 x 415	0.96 kg	110284	110634
125	53	63	5 x 375	0.65 kg	110285	110635
125	64	78	7 x 350	0.56 kg	110290	110640
125	79	90	8 x 300	0.48 kg	110295	110645
125	90	94	11 x 250	0.26 kg	110296	110646
125	96	100	11 x 200	0.24 kg	110297	110647
150	58	69	5 x 475	1.30 kg	110298	110648
150	63	76	5 x 415	1.20 kg	110300	110650
150	75	82	6 x 375	0.75 kg	110305	110655
150	88	103	9 x 350	0.68 kg	110310	110660
150	106	115	10 x 300	0.60 kg	110315	110665
150	113	118	14 x 250	0.34 kg	110316	110666
150	120	124	14 x 200	0.31 kg	110317	110667
200	108	118	7 x 475	1.82 kg	110325	110675
200	115	122	7 x 415	1.68 kg	110330	110680
200	125	138	9 x 375	1.12 kg	110335	110685
200	140	153	13 x 350	1.00 kg	110340	110690
200	156	165	14 x 300	0.81 kg	110345	110695
200	164	168	19 x 250	0.46 kg	110346	110696
200	171	174	19 x 200	0.42 kg	110347	110697



Place MASTER-SEAL around the medium pipe and seal



Push MASTER-SEAL into the annular gap



Tighten each screw one by one in a circular direction by turning once until all modules are evenly tightened



MASTER-SEAL installation complete

MASTER-SEAL

Modular seal

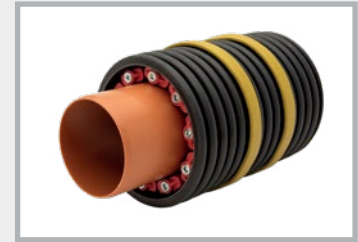

Art.Gr.
445

Area of installation of core drill hole in mm Lining pipe FASO / WELLO / DURO Plus	Medium pipe Outer Ø mm		Type	Weight	Stainless steel	Galvanised
	from	to			Art. no.	Art. no.
250	114	130	6 x 500	3.72 kg	110350	110700
250	137	158	8 x 575	3.32 kg	110355	110705
250	159	166	9 x 475	2.34 kg	110360	110710
250	166	178	7 x 400	2.11 kg	110365	110715
250	178	185	12 x 375	1.50 kg	110370	110720
250	182	189	7 x 425	1.75 kg	110371	110721
250	192	200	17 x 350	1.31 kg	110372	110722
250	194	202	9 x 325	1.22 kg	110373	110723
250	208	213	18 x 300	1.04 kg	110374	110724
300	188	204	10 x 575	4.18 kg	110375	110725
300	206	217	12 x 475	3.10 kg	110380	110730
300	215	226	12 x 415	2.88 kg	110385	110735
300	228	236	15 x 375	1.86 kg	110386	110736
300	232	242	9 x 425	2.28 kg	110387	110737
300	244	253	11 x 325	1.49 kg	110388	110738
300	258	263	22 x 300	1.28 kg	110389	110739
350	219	231	9 x 500	5.57 kg	110390	110740
350	239	253	12 x 575	4.99 kg	110395	110745
350	265	275	14 x 415	3.33 kg	110400	110750
350	276	286	18 x 375	2.23 kg	110405	110755
350	314	317	35 x 250	0.84 kg	110408	110758
400	239	256	10 x 650	9.26 kg	110410	110760
400	265	274	11 x 500	6.81 kg	110415	110765
400	314	328	12 x 400	3.62 kg	110420	110770
400	343	350	15 x 325	2.03 kg	110425	110775
450	358	370	19 x 475	4.90 kg	110430	110780
450	366	379	14 x 400	4.23 kg	110435	110785
450	393	405	17 x 325	2.30 kg	110440	110790
500	311	326	8 x 600	14.69 kg	110443	110793
500	340	358	13 x 650	12.04 kg	110445	110795
500	390	407	18 x 575	7.49 kg	110450	110800
500	409	419	21 x 475	5.42 kg	110455	110805
550	390	408	14 x 650	12.96 kg	110460	110810
550	415	435	15 x 500	9.29 kg	110465	110815
550	440	457	20 x 575	8.32 kg	110470	110820
550	457	470	23 x 475	5.93 kg	110475	110825
600	410	440	10 x 600	18.36 kg	110480	110830
600	440	458	16 x 650	14.82 kg	110485	110835
600	490	505	22 x 575	9.15 kg	110490	110840
600	515	528	19 x 400	5.74 kg	110495	110845

Additional sizes available immediately ex stock

Installation: After insertion of the modular seal and lead-through of the medium pipe, the screws are tightened one by one in a clockwise direction. Give each screw one turn and repeat this procedure several times so the rubber is pressed out uniformly.

Maximum torques	TYPE	200/250/275	3 Nm	500/525	60 Nm	650	85 Nm
		300/325/350/375	15 Nm	575	50 Nm	600	130 Nm
		400/415/425/475	35 Nm				

RONDO Standard

Sealing collars

Reliable sealing against penetrating water and radon

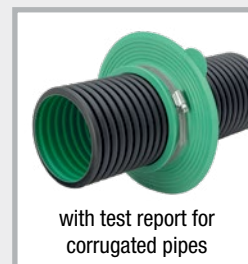

with test report for corrugated pipes

Dimensions Technical details pages 133 – 134

100 m water column

Art.Gr. 400

Art. no.	Type	for pipe outer diameters/mm	Suitable for outer dia. from (mm) to (mm)		PU	Secondary packaging	Weight per pc.	Also for corrugated pipes
090890	RO 10	for lightning protection round conductors	8	10	1 pc.	Carton of 100 pcs.	0.12 kg	
090892	RO flat	for earthing strap	30x3.5 + 30x3		1 pc.		0.18 kg	
090988	RO EFP	for hexagon fixed earthing terminal			1 pc.	Bag of 25 pcs.	0.04 kg	
090900	RO 25	25	25	25	1 pc.		0.16 kg	
090902	RO 32	32	31	32	1 pc.		0.20 kg	
090904	RO 40	40	39	42	1 pc.		0.24 kg	✓
090906	RO 50	50	48	53	1 pc.		0.26 kg	✓
090908	RO 63	63	61	64	1 pc.		0.28 kg	✓
090910	RO 75	75	72	80	1 pc.		0.34 kg	✓
090912	RO 90	90	87	92	1 pc.		0.38 kg	✓
090914	RO 110	Sewage pipe DN 100 110	107	115	1 pc.	Carton of 50 pcs.	0.47 kg	✓
090916	RO 125	Sewage pipe DN 125 125	123	130	1 pc.	Carton of 40 pcs.	0.52 kg	✓
090918	RO 140	140	137	147	1 pc.		0.54 kg	
090920	RO 160	Sewage pipe DN 150 160	157	166	1 pc.	Carton of 35 pcs.	0.63 kg	✓
090921	RO 170	170	167	177	1 pc.		0.62 kg	
090922	RO 180	180	177	187	1 pc.		0.66 kg	
090924	RO 200	Sewage pipe DN 200 200	197	207	1 pc.	Carton of 30 pcs.	0.77 kg	✓
090926	RO 225	225	220	230	1 pc.		0.80 kg	
090928	RO 250	Sewage pipe DN 250 250	245	260	1 pc.		0.88 kg	
090930	RO 280	280	275	290	1 pc.		0.96 kg	
090932	RO 315	Sewage pipe DN 300 315	310	324	1 pc.		1.10 kg	
090934	RO 355	355	350	365	1 pc.		1.22 kg	
090936	RO 400	Sewage pipe DN 400 400	395	410	1 pc.		1.38 kg	
090938	RO 450	450	445	460	1 pc.		1.54 kg	
090940	RO 500	Sewage pipe DN 500 500	495	510	1 pc.		1.68 kg	
090942	RO 560	560	555	570	1 pc.		1.90 kg	
090944	RO 630	630	625	640	1 pc.		2.16 kg	
090946	RO 710	710	705	720	1 pc.		2.40 kg	

Other sizes are available on request.

Installation note: The sealing collars are even easier to install if placed in warm water beforehand (10 minutes).

RONDO Protect

Sealing collars for use in slurry/liquid manure/silage effluent and biogas facilities and where maximum resistance is required.

National technical approval (abZ): Z-74.9-198



with test report for corrugated pipes



Dimensions

Technical details pages 133 – 134

100 m water column

Art.Gr. 409

Art. no.	Type	for pipe outer diameters/mm	Suitable for outer dia. from (mm) to (mm)	PU	Weight per pc.	Also for corrugated pipes
091225	ROPRO 10	for lightning protection round conductors	8 10	1 pc.	0.12 kg	
091226	ROPRO flat	for earthing strap	30x3.5 + 30x3	1 pc.	0.18 kg	
091227	ROPRO 25	25	25 25	1 pc.	0.18 kg	
091228	ROPRO 32	32	31 32	1 pc.	0.20 kg	
091229	ROPRO 40	40	39 42	1 pc.	0.22 kg	✓
091230	ROPRO 50	50	48 53	1 pc.	0.26 kg	✓
091231	ROPRO 63	63	61 64	1 pc.	0.30 kg	✓
091232	ROPRO 75	75	72 80	1 pc.	0.34 kg	✓
091233	ROPRO 90	90	87 92	1 pc.	0.38 kg	✓
091234	ROPRO 110	Sewage pipe DN 100 110	107 115	1 pc.	0.44 kg	✓
091235	ROPRO 125	Sewage pipe DN 125 125	123 130	1 pc.	0.48 kg	✓
091236	ROPRO 140	140	137 147	1 pc.	0.54 kg	
091237	ROPRO 160	Sewage pipe DN 150 160	157 166	1 pc.	0.60 kg	✓
091238	ROPRO 170	170	167 177	1 pc.	0.62 kg	
091239	ROPRO 180	180	177 187	1 pc.	0.66 kg	
091240	ROPRO 200	Sewage pipe DN 200 200	197 207	1 pc.	0.72 kg	✓
091241	ROPRO 225	225	220 230	1 pc.	0.82 kg	
091242	ROPRO 250	Sewage pipe DN 250 250	245 260	1 pc.	0.90 kg	
091243	ROPRO 280	280	275 290	1 pc.	0.98 kg	
091244	ROPRO 315	Sewage pipe DN 300 315	310 324	1 pc.	1.10 kg	
091245	ROPRO 355	355	350 365	1 pc.	1.22 kg	
091246	ROPRO 400	Sewage pipe DN 400 400	395 410	1 pc.	1.36 kg	
091248	ROPRO 450	450	445 460	1 pc.	1.54 kg	
091250	ROPRO 500	500	495 510	1 pc.	1.68 kg	
091252	ROPRO 560	560	555 570	1 pc.	1.88 kg	
091254	ROPRO 630	630	625 640	1 pc.	2.14 kg	
091256	ROPRO 710	710	705 720	1 pc.	2.34 kg	

Installation note: The sealing collars are even easier to install if placed in warm water beforehand (10 minutes).

RONDO Ecco

The economical sealing collar for waterproofing of pipes and cables



80 m water column

Art.Gr.
401

Dimensions

Art. no.	Type	Suitable for from to	PU	Secondary packaging	Weight per pc.
091050	RO Ecco 110	107-115 mm	1 pc.	Carton of 80 pcs.	0.26 kg
091053	RO Ecco 125	122-130 mm	1 pc.	Carton of 70 pcs.	0.30 kg
091056	RO Ecco 160	157-170 mm	1 pc.	Carton of 60 pcs.	0.36 kg
091059	RO Ecco 200	197-210 mm	1 pc.	Carton of 50 pcs.	0.42 kg

RONDO Base

The sealing collar with only one fastening strap



70 m water column

Art.Gr.
402

Dimensions

Art. no.	Type	for pipe outer diameters/mm	PU	Secondary packaging	Weight per pc.
090978	RO Base 110	110	1 pc.	Carton of 25 pcs.	0.18 kg
090980	RO Base 125	125	1 pc.	Carton of 25 pcs.	0.19 kg
090984	RO Base 160	160	1 pc.	Carton of 25 pcs.	0.20 kg
090990	RO Base 200	200	1 pc.	Carton of 25 pcs.	0.27 kg

RONDO sealing collars

Water pressure-tight sealing for pipe ducts through concrete parts



RONDO Standard

page 130

- Pressure water-tight up to 100 m water column
 - Radon-tight
 - Good resistances
 - For corrugated pipes with outer diam. of up to 200 mm
- Pressure water-tight up to 30 m water column



RONDO Protect

page 131

- Pressure water-tight up to 100 m water column
 - DIBt approval for slurry/liquid manure/silage effluent facilities
 - Also for agricultural buildings
 - Highest resistances
 - For corrugated pipes with outer diam. of up to 200 mm
- Pressure water-tight up to 30 m water column



RONDO Ecco

page 132

- Pressure water-tight up to 80 m water column



RONDO Base

page 132

- Pressure water-tight up to 70 m water column

Wherever pipes or other lines are routed through concrete parts, they must be sealed against the permeation of water and/or gases present, such as methane gas or the radioactive radon gas that is sometimes present in the soil.

The RONDO sealing collars create a cost-effective and easy-to-install solution for sealing penetrations. They are available in all common nominal diameters of pipes and lines as standard.



The RONDO, shortly before placement of concrete. The drainpipes are securely and permanently sealed against rising moisture.

Technical data

	RONDO Standard	RONDO Protect	RONDO Ecco	RONDO Base
Colour	green	red	green	green
Material	TPE	modified TPE	TPE	TPE
Size	10-710 mm	10-710 mm	110-200 mm	90-315 mm
Height of waterstop	4 cm	4 cm	3 cm	1.5 cm
Number of waterstops	1	1	1	2
Bearing width	6 cm	6 cm	4.5 cm	2.5 cm
Pressure test	100 m water column	100 m water column	80 m water column	70 m water column
Resistance				
Diluted acids	✓	✓	✓	✓
Alkalis	✓	✓	✓	✓
Ground water	✓	✓	✓	✓
Radon	✓	✓	✓	✓
Liquid manure	✓	✓	✓	✓
Slurry	✓	✓	✓	✓
Fermentation mash		✓		
Methane gas		✓		
Animal excretions		✓		
Silage effluent		✓		
Diluted sulphuric acid		✓		
Further resistances are available on request				

Installation using the example of the RONDO Standard sealing collar



Sewage pipe and RONDO Standard 110

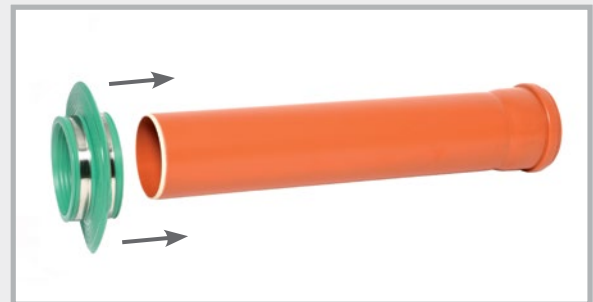

Pushing on the sealing collar

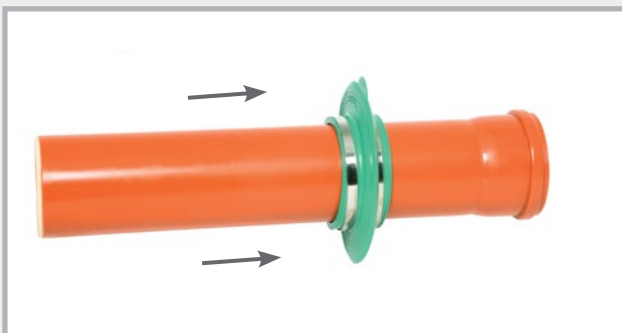

Positioning the sealing collar

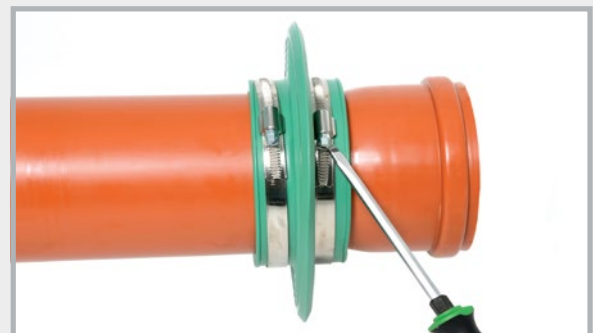

Securing by tightening the fastening straps

The surface of the pipe should be cleaned, if dirty.

Pipe bushing systems

Pressure water-tight installation parts for wall and floor slab penetration of sewer pipes



**Pipe bushing
UniCut**

pages 136 – 137



**Pipe bushing
Base / Novo**

page 138

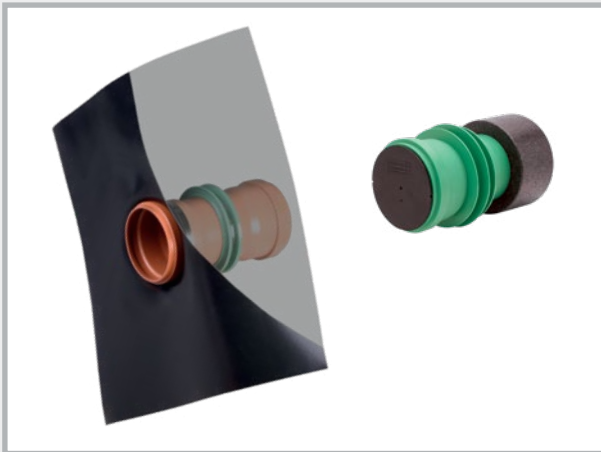

**Pipe bushing
Special versions**

pages 139 – 140



**Ground drains
+ Accessories**

pages 141 – 142

Sewer pipes are among the most common kinds of pipes to pass through concrete parts.

Our pipe bushing systems offer ready-to-install system solutions for wall and floor slab ducts for the common materials (KG and KG 2000).

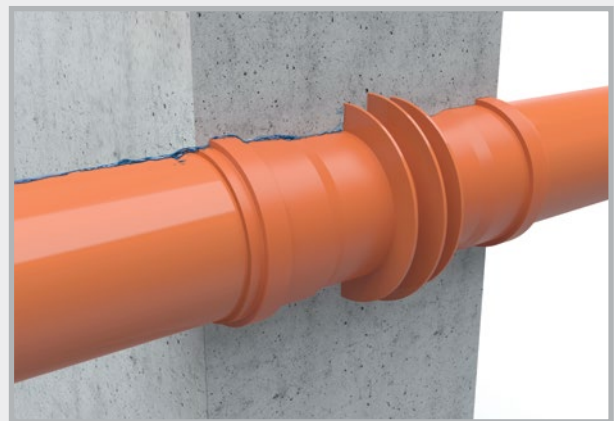

Pipe bushing Novo as a pressure water-tight wall duct.

UniCut pipe bushing

NEW! prefabricated for the respective wall thickness

- Diameter: 110 mm
- Prefabricated pipe bushing available in the following wall thicknesses:
200 / 240 / 250 / 300 / 350 / 365 / 400 mm
- Pressure water-tight “Novo” waterstop
- Trowel flange for the connection of the outer seal
- Nail holes for fixing to the formwork
- Maintains the flow direction
- Supplied with 2 closure plugs



Art. no.	Description	DN mm	Wall thicknesses	PU	Weight per pc.
081520	UniCut pipe bushing, KG	110	200 mm	1 pc.	1.01 kg
081521	UniCut pipe bushing, KG	110	240 mm	1 pc.	1.06 kg
081522	UniCut pipe bushing, KG	110	250 mm	1 pc.	1.07 kg
081523	UniCut pipe bushing, KG	110	300 mm	1 pc.	1.13 kg
081524	UniCut pipe bushing, KG	110	350 mm	1 pc.	1.19 kg
081525	UniCut pipe bushing, KG	110	365 mm	1 pc.	1.20 kg
081526	UniCut pipe bushing, KG	110	400 mm	1 pc.	1.24 kg
081530	UniCut pipe bushing, KG 2000	110	200 mm	1 pc.	1.12 kg
081531	UniCut pipe bushing, KG 2000	110	240 mm	1 pc.	1.19 kg
081532	UniCut pipe bushing, KG 2000	110	250 mm	1 pc.	1.20 kg
081533	UniCut pipe bushing, KG 2000	110	300 mm	1 pc.	1.28 kg
081534	UniCut pipe bushing, KG 2000	110	350 mm	1 pc.	1.36 kg
081535	UniCut pipe bushing, KG 2000	110	365 mm	1 pc.	1.38 kg
081536	UniCut pipe bushing, KG 2000	110	400 mm	1 pc.	1.44 kg

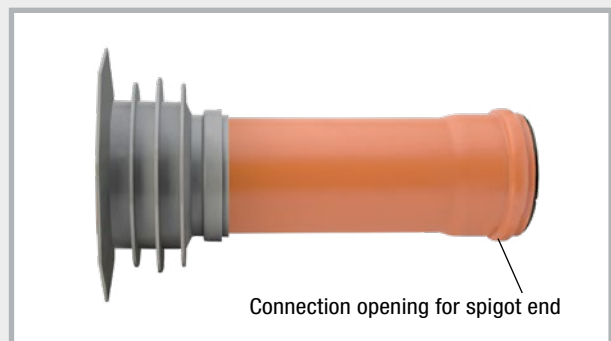
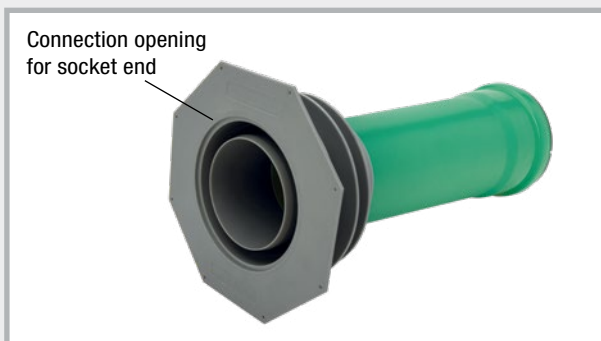

Art. no.	Description	PU	Secondary packaging	Weight per pc.	
081510	UniCut flange part “SOLO” Ø 110 mm with plug and seal, for on-site connection of KG and KG 2000 pipes Ø 110 mm	1 pc.	Carton of 20 pcs.	0.69 kg	

1 SWELLING TAPES
2 JOINT SHEET METALS
3 INJECTION HOSES CONSTRUCTION CHEMISTRY
4 SERVICE DUCTS
5 LIGHTNING PROTECTION
6 FORMWORK ACCESSORIES

Installation of UniCut pipe bushing



1 Fastening the UniCut pipe bushing

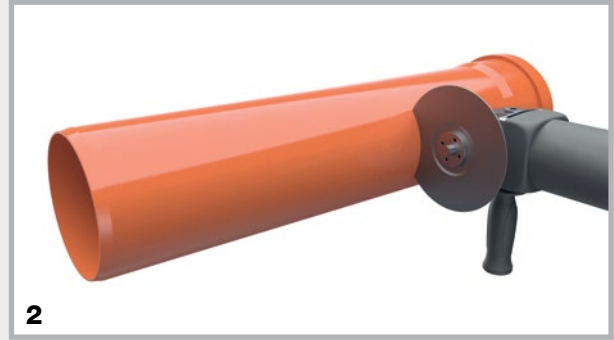

2 Cut the KG or KG 2000 pipe to length:
Wall thickness minus 8.5 cm

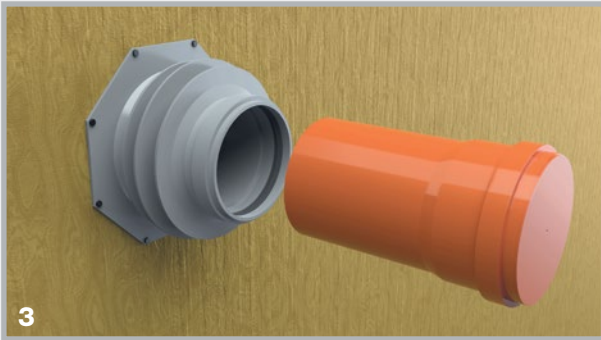

3 Insert the pipe into the UniCut pipe bushing.



4 Concreting and careful sealing

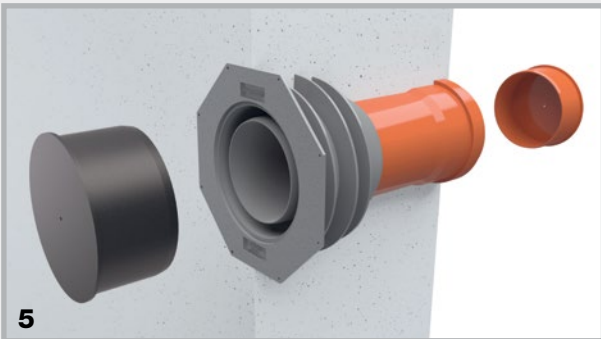

5 Remove the plugs after concreting

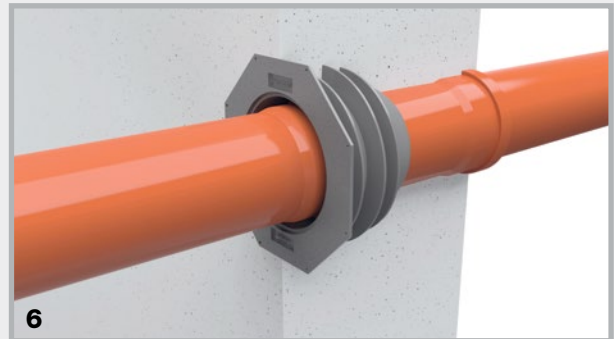

6 The drainpipes in KG or KG 2000 can be inserted on the left into the socket end or on the right into the spigot end.

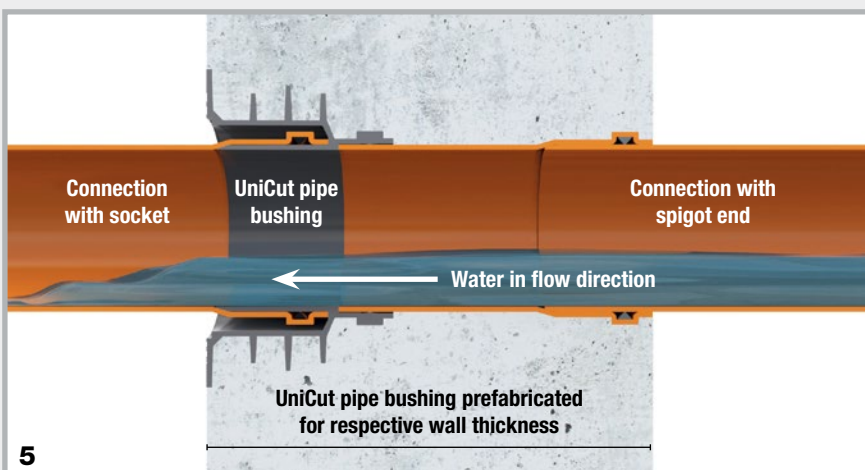

5

Function:

When installing the UniCut pipe bushing, the direction of flow of the water is guaranteed.

Sewage pipe bushing systems

Double socket type (DM)



Advantages of the Base and Novo double socket

- Delivered as solid wall version
- With lip seal
- Manufactured for corresponding wall thickness
- Radon-tight
- Incl. 2 plugs as installation aid
- Pre-installed waterstop

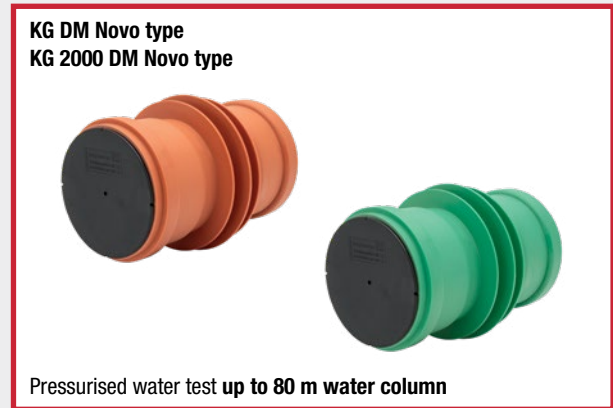
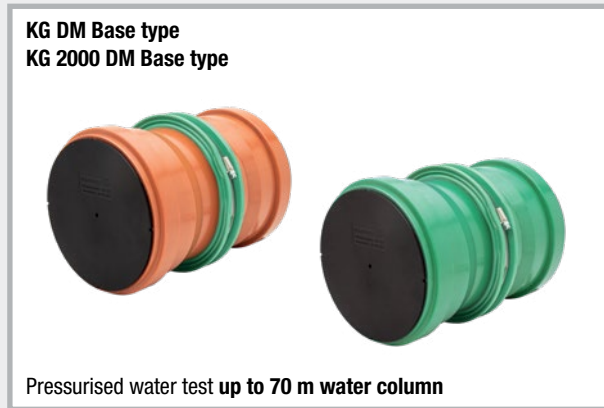

KG DM type product range [Technical details page 140](#)

Art.Gr. 412

Sewage pipe Ø DN mm	Wall thicknesses							Order FIX formwork aid separately
	180 mm	200 mm	240 mm	250 mm	300 mm	365 mm	400 mm	
	Base double socket		Novo double socket					
DN 110	080404	080405	080350	080351	080352	080353	080354	
Weight/pc.	0.76 kg	0.78 kg	0.66 kg	0.67 kg	0.74 kg	0.83 kg	0.85 kg	
DN 125	080419	080420	080355	080356	080357	080358	080359	
Weight/pc.	0.95 kg	0.99 kg	0.87 kg	0.90 kg	1.01 kg	1.11 kg	1.19 kg	
DN 160	not producible according to DIN	080433	080434	080436	080438	080440	080442	
Weight/pc.		1.41 kg	1.50 kg	1.58 kg	1.71 kg	2.02 kg	2.31 kg	
DN 200	not producible according to DIN	080443	080444	080445	080446	080448	080450	
Weight/pc.		2.14 kg	2.39 kg	2.44 kg	2.74 kg	2.99 kg	3.20 kg	

KG 2000 DM type product range

Art.Gr. 412

KG 2000 Ø DN mm	Wall thicknesses						Order FIX formwork aid separately
	200 mm	240 mm	250 mm	300 mm	365 mm	400 mm	
	Base double socket	Novo double socket					
DN 110	080750	080800	080801	080802	080803	080804	
Weight/pc.	0.80 kg	0.65 kg	0.67 kg	0.73 kg	0.81 kg	0.86 kg	
DN 125	080762	080805	080806	080807	080808	080809	
Weight/pc.	1.07 kg	0.88 kg	0.89 kg	1.02 kg	1.10 kg	1.20 kg	
DN 160	080774	080776	080778	080780	080782	080784	
Weight/pc.	1.69 kg	1.45 kg	1.48 kg	1.84 kg	2.21 kg	2.31 kg	
DN 200	080786	080788	080790	080792	080794	080796	
Weight/pc.	2.61 kg	2.15 kg	2.24 kg	3.00 kg	3.27 kg	3.49 kg	

The Base double socket version is available for further wall thicknesses.

1 SWELLING TAPES
2 JOINT SHEET METALS
3 INJECTION HOSES CONSTRUCTION CHEMISTRY
4 SERVICE DUCTS
5 LIGHTNING PROTECTION
6 FORMWORK ACCESSORIES

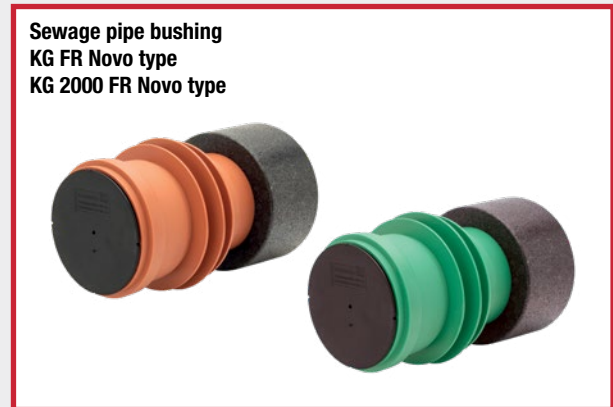
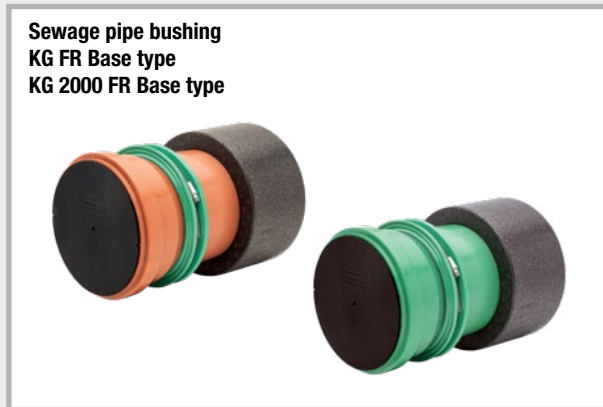

Flow direction (FR) type Base + Novo



The flow direction type is manufactured in one piece for the corresponding wall thickness. You can also prepare any wall thickness yourself on the building site with a ground drain and socket ring. The FR type facilitates the wastewater flow in one direction.

KG FR type product range



Art.Gr.
414

Sewage pipe Ø DN mm	Wall thicknesses							Order FIX formwork aid separately
	180 mm	200 mm	240 mm	250 mm	300 mm	365 mm	400 mm	
	Base flow direction			Novo flow direction				
DN 110 Weight/pc.	090710 0.75 kg	090713 0.80 kg	090716 0.90 kg	090719 0.90 kg	090722 1.00 kg	090725 1.10 kg	090728 1.20 kg	
DN 125 Weight/pc.	090731 1.00 kg	090734 1.00 kg	090737 1.10 kg	090740 1.10 kg	090743 1.25 kg	090749 1.45 kg	090752 1.65 kg	
DN 160 Weight/pc.	not producible according to DIN	not producible according to DIN	090758 1.85 kg	090761 1.85 kg	090764 2.05 kg	090770 2.25 kg	090773 2.50 kg	
DN 200 Weight/pc.	not producible according to DIN	not producible according to DIN	090779 3.00 kg	090782 3.20 kg	090785 3.35 kg	090788 3.60 kg	090791 3.70 kg	

Other wall thicknesses available

KG 2000 FR type product range

Art.Gr.
414

KG 2000 Ø DN mm	Wall thicknesses						Order FIX formwork aid separately
	200 mm	240 mm	250 mm	300 mm	365 mm	400 mm	
	Base flow direction		Novo flow direction				
DN 110 Weight/pc.	080820 0.80 kg	080825 0.85 kg	080830 0.90 kg	080835 1.10 kg	080845 1.30 kg	080850 1.40 kg	
DN 125 Weight/pc.	080855 1.10 kg	080860 1.20 kg	080865 1.20 kg	080870 1.30 kg	080880 1.50 kg	080885 1.60 kg	
DN 160 Weight/pc.	not producible according to DIN	080890 1.80 kg	080895 2.00 kg	080905 2.30 kg	080915 2.60 kg	080920 2.80 kg	
DN 200 Weight/pc.	not producible according to DIN	080923 3.10 kg	080925 3.20 kg	080933 3.20 kg	080935 3.70 kg	080945 3.85 kg	

Other wall thicknesses available

Flow direction (FR) type

Function and technology

1. KG 2000 flow direction type pipe bushing, concreted into the wall
2. The socket ring is removed before the next pipe is connected.
3. The next pipe is connected. The flow direction of the water is retained.

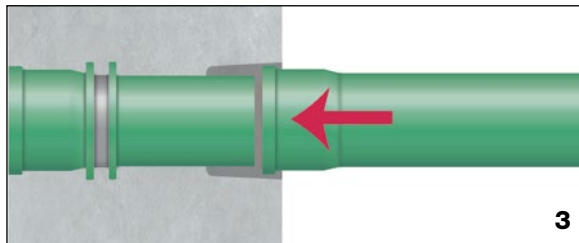
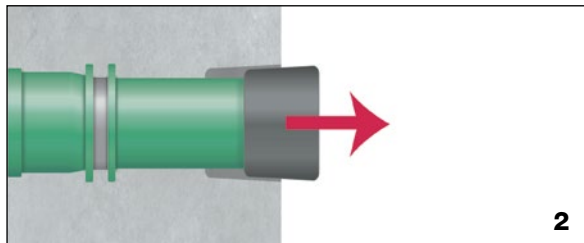
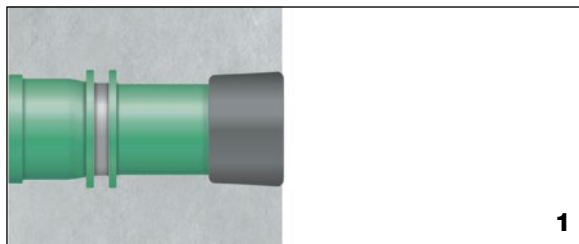

KG type Base and Novo double socket

Function and technology

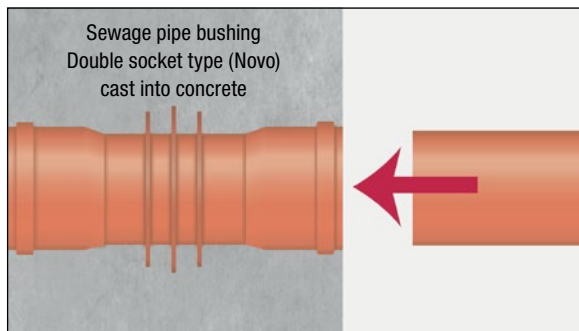
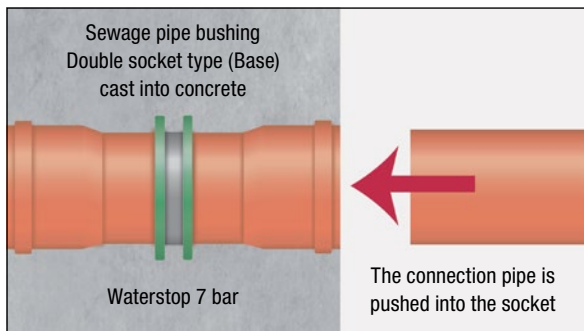

The double socket is cast into concrete. After concreting, the closure plugs are removed and the seals inserted. The next pipe can be connected.

Double socket double wall (DM DW) type

Additional waterstops in the shell area of cavity walls.



Sewage pipe bushing DM DW type



KG 2000 pipe bushing DM DW type



available on request

Foil flange (FFL) type



In addition to the pressure water and radon-resistant seal in the concrete provided by the RONDO Base, the foil flange enables the pipe bushing to be integrated into an outer sealing level.

**Foil flange made of PVC foil, 1.5 mm,
Size: 50 x 50 cm,
weldable with hot air gun,
bondable with solvent welding agent,
resistant to oil and bitumen**

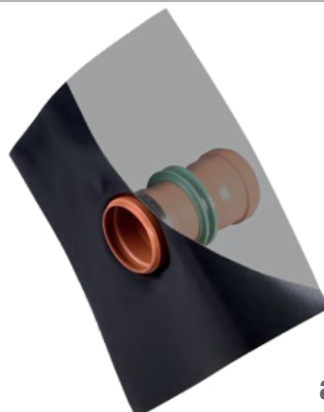

available on request

Ground drains



KG sewage ground drains Solid wall pipes

KG sewage pipe, 0.5 m long, with waterstop and socket on one end



Art.Gr.
418

Type	Sewage pipe Ø DN mm	Length mm	WITHOUT plug		NEW!	WITH plug		Novo type DN 110 + 125 mm	Base type DN 160 + 200 mm
			Art. no.	Weight per pc.	Art. no.	Weight per pc.			
DL 110/500	110	500	080366	0.88 kg	080366D	0.90 kg			
DL 125/500	125	500	080368	1.14 kg	080368D	1.17 kg			
DL 160/500	160	500	080470	2.03 kg	080470D	2.08 kg			
DL 200/500	200	500	080475	3.21 kg	080475D	3.29 kg			

KG 2000 sewage ground drains Solid wall pipes

KG 2000 sewage pipe, 0.5 m long, with waterstop and socket on one end



Art.Gr.
418

Type	Sewage pipe Ø DN mm	Length mm	WITHOUT plug		NEW!	WITH plug		Novo type DN 110 + 125 mm	Base type DN 160 + 200 mm
			Art. no.	Weight per pc.	Art. no.	Weight per pc.			
DL2000 110/500	110	500	080827	0.89 kg	080827D	0.91 kg			
DL2000 125/500	125	500	080828	1.12 kg	080828D	1.15 kg			
DL2000 160/500	160	500	080986	2.24 kg	080986D	2.29 kg			
DL2000 200/500	200	500	080989	3.64 kg	080989D	3.72 kg			

Function and technology

KG and KG 2000 ground drains are used for floor slab penetrations.

The ground drains are connected to the sewer base lines and concreted in up to the top edge of the floor slab. The transition from the pipe to the concrete is reliably and permanently sealed against pressing water or gases rising from the ground by the "Novo" or "Base" waterstop.

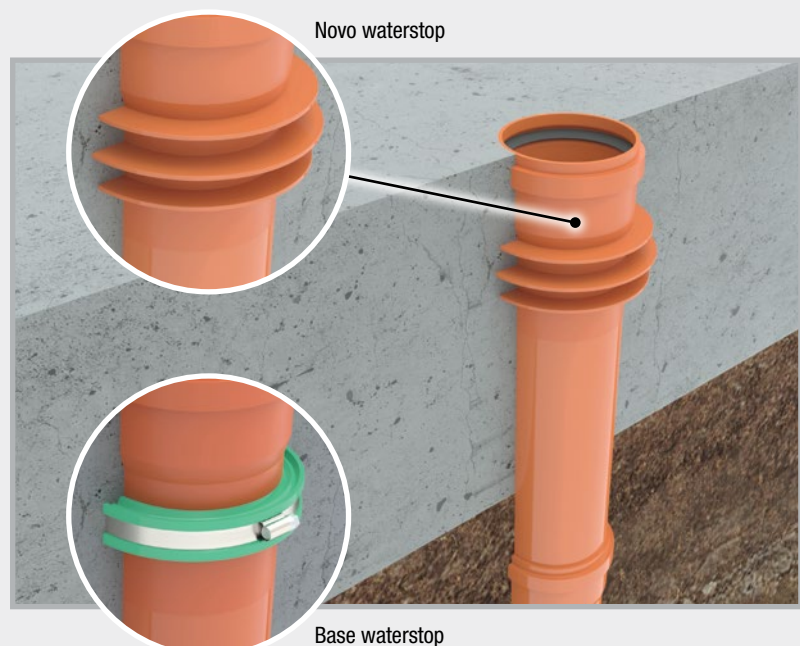

Sewage ground drains with foil flange

Foil flange made of PVC foil 1.5 mm, size: 50 x 50 cm, weldable with hot air gun, bondable with solvent welding agent, resistant to oil and bitumen

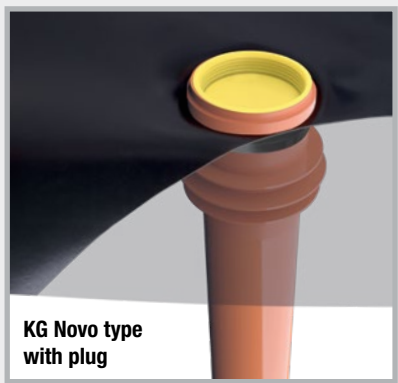

KG sewage ground drains with foil flange – solid wall pipes

Sewage pipe, 0.5 m long, with waterstop and socket on one end

Art.Gr. 419

Type	Sewage pipe Ø DN mm	Length mm	WITHOUT plug		NEW! WITH plug	
			Art. no.	Weight per pc.	Art. no.	Weight per pc.
DL 110/500 FFL	110	500	080451	1.52 kg	080451D	1.54 kg
DL 125/500 FFL	125	500	080452	1.81 kg	080452D	1.84 kg
DL 160/500 FFL	160	500	080454	2.51 kg	080454D	2.56 kg
DL 200/500 FFL	200	500	080456	4.43 kg	080456D	4.51 kg



KG 2000 ground drains with foil flange

KG 2000 pipe, 0.5 m long, with waterstop and socket on one end

Art.Gr. 419

Type	Sewage pipe Ø DN mm	Length mm	WITHOUT plug		NEW! WITH plug	
			Art. no.	Weight per pc.	Art. no.	Weight per pc.
DL2000 110/500 FFL	110	500	080992	1.52 kg	080992D	1.54 kg
DL2000 125/500 FFL	125	500	080994	1.96 kg	080994D	1.99 kg
DL2000 160/500 FFL	160	500	080996	2.70 kg	080996D	2.75 kg
DL2000 200/500 FFL	200	500	080998	4.23 kg	080998D	4.31 kg

For fixing the foil flange to the component, we recommend the POWER swelling tape adhesive (art. no. 010052) on page 12 of the complete catalogue.



LIGHTNING PROTECTION



Earth conductors
pages 144 – 145



Connectors
pages 146 – 151



Fixed earthing terminals, wall bushings + accessories
pages 152 – 165

Earth conductors

Dimensions and materials according to DIN EN 62561-2

Earthing straps

Galvanised steel

Art.Gr.
500

Art. no.	Size	Material	PU	Secondary packaging
100014	30 x 3.5 mm	Galvanised steel Z 500	1 roll of 25 kg = approx. 30 m	1 pallet = 40 rolls
100016	30 x 3.5 mm	Galvanised steel Z 500	1 roll of 50 kg = approx. 60 m	1 pallet = 20 rolls
100022	40 x 4.0 mm	Galvanised steel Z 500	1 roll of 50 kg = approx. 39 m	1 pallet = 20 rolls
100024	40 x 5.0 mm	Galvanised steel Z 500	1 roll of 50 kg = approx. 32 m	1 pallet = 20 rolls

Stainless steel

Art. no.	Size	Material	PU	Secondary packaging
100028	30 x 3.5 mm Art.Gr. 502	V2A stainless steel according to DIN EN 62561-2	1 roll of 25 kg = approx. 30 m	1 pallet = 40 rolls
100031	30 x 3.5 mm Art.Gr. 501	V4A stainless steel according to DIN EN 62561-2	1 roll of 25 kg = approx. 30 m	1 pallet = 40 rolls
100032	30 x 3.5 mm Art.Gr. 501	V4A stainless steel according to DIN EN 62561-2	1 roll of 50 kg = approx. 60 m	1 pallet = 20 rolls
100035	40 x 4.0 mm Art.Gr. 501	V4A stainless steel according to DIN EN 62561-2	1 roll of 50 kg = approx. 39 m	1 pallet = 20 rolls

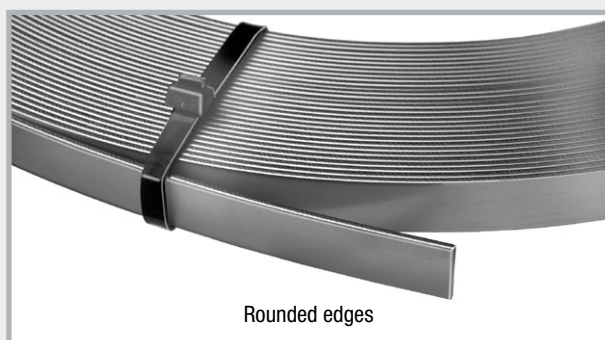
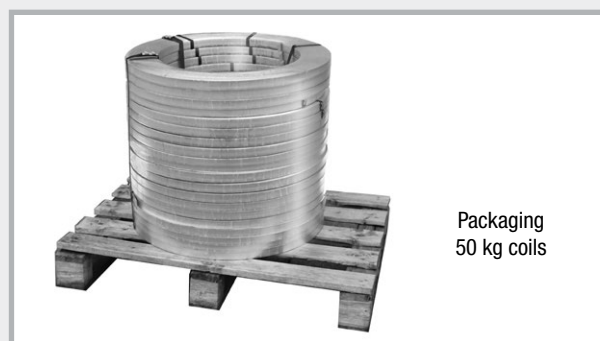
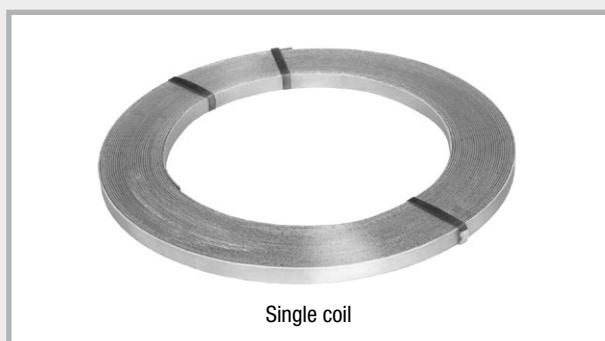

Round wires



Single coil, galvanised

Single coil
Stainless steel standardSingle coil
Stainless steel SUPER-SOFTSingle coil
Aluminium round wire

Galvanised steel

Art.Gr.
505

Art. no.	Size	Material	PU	Secondary packaging
100041	Ø 10 mm	Galvanised steel Z 350	1 roll of 25 kg = approx. 40.5 m	1 pallet = 40 rolls
100042	Ø 10 mm	Galvanised steel Z 350	1 roll of 50 kg = approx. 81 m	1 pallet = 20 rolls

Stainless steel standard

Art. no.	Size	Material	PU	Secondary packaging
100051	Ø 10 mm Art.Gr. 507	V2A stainless steel according to DIN EN 62561-2	1 roll of 25 kg = approx. 40.5 m	1 pallet = 20 rolls
100055	Ø 10 mm Art.Gr. 506	V4A stainless steel according to DIN EN 62561-2	1 roll of 25 kg = approx. 40.5 m	1 pallet = 20 rolls
100056	Ø 10 mm Art.Gr. 506	V4A stainless steel according to DIN EN 62561-2	1 roll of 50 kg = approx. 81 m	1 pallet = 10 rolls
100062	Ø 10 mm Art.Gr. 506	V4A stainless steel according to DIN EN 62561-2	1 roll of 31 kg = approx. 50 m	1 pallet = 16 rolls

Stainless steel SUPER-SOFT

A special manufacturing procedure ensures uniformly soft quality of the wire. SUPER-SOFT can be unrolled very easily and lies flat without undulation.

Art.Gr.
508

Art. no.	Size	Material	PU	Secondary packaging
100061	Ø 10 mm	SUPER-SOFT V4A according to DIN EN 62561-2, inner diameter 900 mm	1 roll of 25 kg = approx. 40.5 m	1 pallet = 40 rolls

Aluminium

Art.Gr.
509

Art. no.	Size	Material	PU	Secondary packaging
100080	Ø 8 mm	ALU AlMgSi soft-twistable	1 roll of 20 kg = approx. 148 m	1 pallet = 25 rolls

Multi-purpose connecting clamps

with mushroom head bolt and protection against twisting

Art.Gr.
511



Art. no.	Description	PU	Secondary packaging	Weight per carton
100147	Galvanised steel , 2-part, round/round, Clamping range: Round conductor Ø 8 + 10 mm, with M10 mushroom head bolt and protection against twisting	1 carton of 50 pcs.	1 pallet = 5600 pcs.	5.05 kg
100149	V2A stainless steel , 2-part, round/round Clamping range: Round conductor Ø 8 + 10 mm, with M10 mushroom head bolt and protection against twisting	1 carton of 50 pcs.	1 pallet = 5600 pcs.	4.45 kg
100150	V4A stainless steel , 2-part, round/round Clamping range: Round conductor Ø 8 + 10 mm, with M10 mushroom head bolt and protection against twisting	1 carton of 50 pcs.	1 pallet = 5600 pcs.	4.50 kg

Multi-purpose connecting clamps

with thread in lower part

Art.Gr.
511



Art. no.	Description	PU	Secondary packaging	Weight per carton
100157	Galvanised steel , 2-part, round/round, Clamping range: Ø 8 + 10 mm, M10 screw, thread in lower part	1 carton of 50 pcs.	1 pallet = 5600 pcs.	4.45 kg
100159	V4A stainless steel , 2-part, round/round Clamping range: Ø 8 + 10 mm, M10 screw, thread in lower part	1 carton of 50 pcs.	1 pallet = 5600 pcs.	3.75 kg
100153	Aluminium , 2-part, round/round, Clamping range: Ø 8 + 10 mm, NIRO M10 screw, Thread in lower part	1 carton of 50 pcs.	1 pallet = 5600 pcs.	2.60 kg

MAXI multi-purpose connecting clamp

for connection of round conductors to the
reinforcement and conductive connection of
steel reinforcement with up to Ø 25 mm

Art.Gr.
511

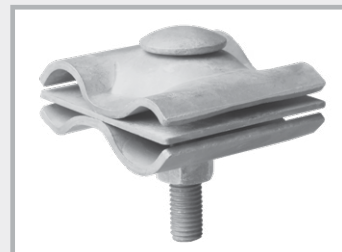

Art. no.	Description	PU	Secondary packaging	Weight per carton
100148	Galvanised steel , round/round, Round conductor Ø 8-16 mm / Ø 15-25 mm, with mushroom head bolt and protection against twisting	1 carton of 25 pcs.	1 pallet = 1000 pcs.	11.10 kg
100152	V4A stainless steel , round/round, Round conductor Ø 8-16 mm / Ø 15-25 mm, with mushroom head bolt and protection against twisting	1 carton of 25 pcs.	1 pallet = 1000 pcs.	10.05 kg

Stainless steel cross connectors round/round

Universal for flat/flat, flat/round and round/round

Clamping range: round conductor \varnothing 8 + 10 mm, flat conductor up to 30 mm

Art.Gr.
512

Art. no.	Description	PU	Secondary packaging	Weight per carton
100143	V4A stainless steel , 2-part, round/round universal, heavy duty version, M8 screws	1 carton of 50 pcs.	1 pallet = 3200 pcs.	9.55 kg
100145	V4A stainless steel , 2-part, round/round universal, light version, M6 screws	1 carton of 50 pcs.	1 pallet = 3200 pcs.	6.90 kg

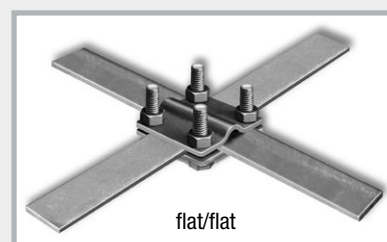
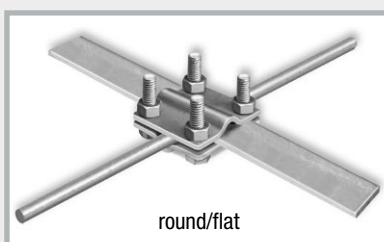
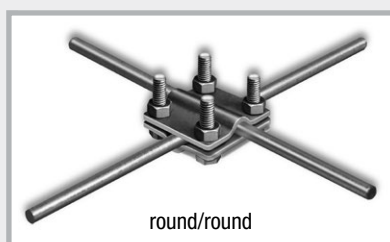

Galvanised cross connectors flat/flat

Clamping range: flat conductor up to 30 mm

Art.Gr.
512

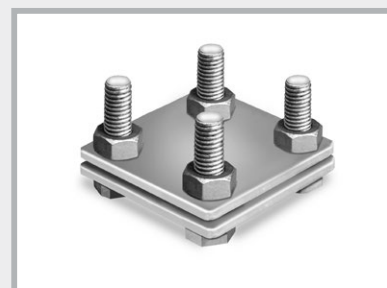

Art. no.	Description	PU	Secondary packaging	Weight per carton
100100	Galvanised steel , 2-part, flat/flat, heavy duty version, M8 screws	1 carton of 50 pcs.	1 pallet = 3200 pcs.	10.75 kg
100106	Galvanised steel , 2-part, flat/flat, light version, M6 screws	1 carton of 50 pcs.	1 pallet = 3200 pcs.	7.65 kg

Galvanised cross connectors flat/round

Clamping range:
round conductor \varnothing 8 + 10 mm,
flat conductor up to 30 mm

Art.Gr.
512

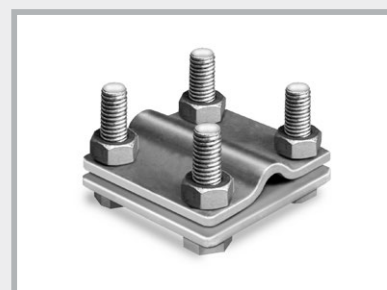

Art. no.	Description	PU	Secondary packaging	Weight per carton
100115	Galvanised steel , 2-part, flat/round, heavy duty version, M8 screws	1 carton of 50 pcs.	1 pallet = 3200 pcs.	10.80 kg
100121	Galvanised steel , 2-part, flat/round, light version, M6 screws	1 carton of 50 pcs.	1 pallet = 3200 pcs.	7.80 kg

Galvanised cross connector (for flat conductors up to 30 mm) round/round

Universal for flat/flat, flat/round and round/round

Clamping range: round conductor \varnothing 8 + 10 mm, flat conductor 30 mm

Art.Gr.
512

Art. no.	Description	PU	Secondary packaging	Weight per carton
100127	Galvanised steel, 2-part, round/round, heavy duty version, M8 screws	1 carton of 50 pcs.	1 pallet = 3200 pcs.	10.95 kg
100130	Galvanised steel, 3-part, round/round, heavy duty version, M8 screws With intermediate plate	1 carton of 50 pcs.	1 pallet = 3200 pcs.	14.65 kg
100133	Galvanised steel, 2-part, round/round, light version, M6 screws	1 carton of 50 pcs.	1 pallet = 3200 pcs.	8.00 kg

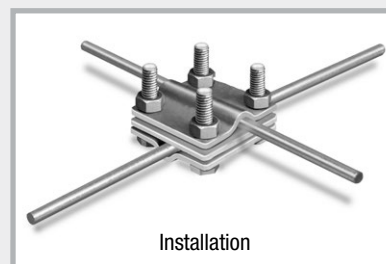
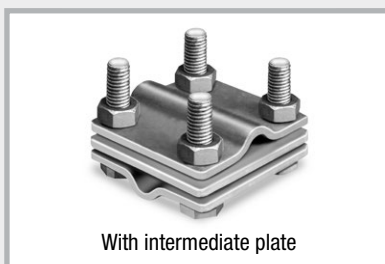
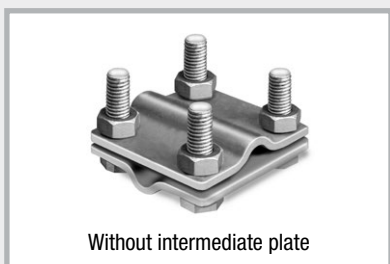

Galvanised cross connector (for flat conductors up to 40 mm) round/round

Universal for flat/flat, flat/round and round/round

Clamping range: round conductor \varnothing 8 + 10 mm, flat conductor 30 + 40 mm

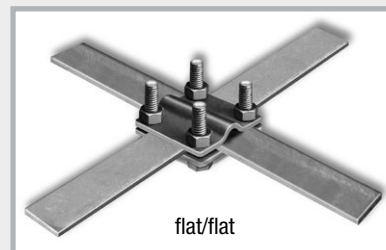
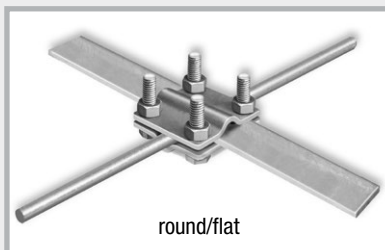
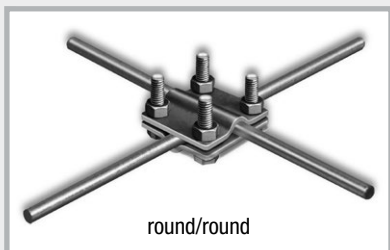

Art.Gr.
512

Art. no.	Description	PU	Secondary packaging	Weight per carton
100129	Galvanised steel, 2-part, round/round, heavy duty version, M8 screws	1 carton of 50 pcs.	1 pallet = 3200 pcs.	17.60 kg





Art.Gr.
518

Connecting clamps for flat conductors

Art. no.	Description	PU	Secondary packaging	Weight per carton	
100250	Galvanised steel , M10 screw, flat conductors up to 30 mm and constructional steel Ø 6-22 mm	1 carton of 50 pcs.	1 pallet = 4000 pcs.	6.95 kg	Art. no. 100250 Art. no. 100251 
100251	Bright steel , M10 screw, flat conductors up to 30 mm and constructional steel Ø 6-22 mm	1 carton of 50 pcs.	1 pallet = 4000 pcs.	6.45 kg	
100253	Galvanised steel , M10 screw, flat conductors up to 40 mm and constructional steel Ø 6-22 mm	1 carton of 50 pcs.	1 pallet = 3200 pcs.	6.05 kg	Art. no. 100252 Art. no. 100253 
100252	V4A stainless steel , M10 screw flat conductors up to 40 mm and constructional steel Ø 6-22 mm	1 carton of 50 pcs.	1 pallet = 3200 pcs.	5.25 kg	

Art.Gr.
518

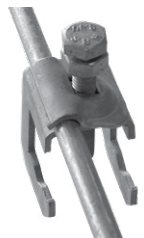
Connecting clamps for flat and round conductors

Art. no.	Description	PU	Secondary packaging	Weight per carton	
100255	Galvanised steel , M10 screw, for flat conductors up to 30 mm, Round conductor Ø 8 + 10 mm, Constructional steel Ø 6-22 mm	1 carton of 50 pcs.	1 pallet = 3200 pcs.	9.30 kg	Art. no. 100255 Art. no. 100257 
100257	V4A stainless steel , M10 screw, for flat conductors up to 30 mm, Round conductor Ø 8 + 10 mm, Constructional steel 6-22 mm	1 carton of 50 pcs.	1 pallet = 3200 pcs.	8.05 kg	
100146	Universal connecting clamp with pressure plate, Galvanised steel , M10 screw, for flat conductors up to 30 mm, Round conductor Ø 8 + 10 mm, Constructional steel Ø 6-22 mm	1 carton of 50 pcs.	1 pallet = 3200 pcs.	7.55 kg	Art. no. 100146 Art. no. 100254  Pressure plate
100254	Universal connecting clamp with pressure plate, V4A stainless steel , M10 screw, for flat conductors up to 30 mm, Round conductor Ø 8 + 10 mm, Constructional steel Ø 6-22 mm	1 carton of 50 pcs.	1 pallet = 3200 pcs.	6.40 kg	

Art.Gr.
518

Connecting clamps for round conductors

Art. no.	Description	PU	Secondary packaging	Weight per carton	
NEW! 100258	Galvanised steel , M10 screw, for round connector Ø 6-10 mm, Constructional steel Ø 6-10 mm	1 carton of 50 pcs.	1 pallet = 4000 pcs.	5.00 kg	Art. no. 100258 Art. no. 100259 Art. no. 100260 Art. no. 100261 
100259	Galvanised steel , M10 screw, for round conductors Ø 8 + 10 mm, Constructional steel Ø 6-22 mm	1 carton of 50 pcs.	1 pallet = 3200 pcs.	5.85 kg	
100261	Bright steel , M10 screw, for round conductors Ø 8 + 10 mm, Constructional steel Ø 6-22 mm	1 carton of 50 pcs.	1 pallet = 3200 pcs.	5.60 kg	
100260	V4A stainless steel , M10 screw, for round conductors Ø 8 + 10 mm, Constructional steel Ø 6-22 mm	1 carton of 50 pcs.	1 pallet = 3200 pcs.	5.10 kg	

Double clamps

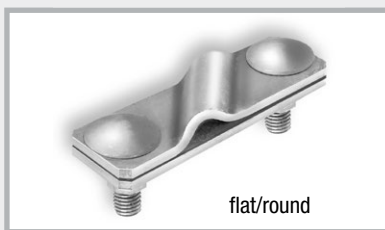
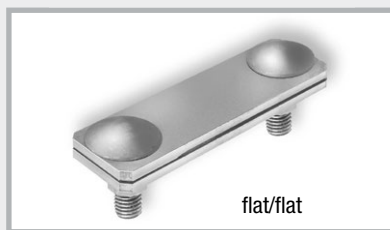

Stainless steel double clamps

for earthing strap up to 40 mm width and round conductors $\varnothing 8 + 10$ mm

Art.Gr.
513

Art. no.	Description	PU	Secondary packaging	Weight per carton
100273	V4A stainless steel, 2-part, flat/flat, heavy duty version, M10 screws	1 carton of 50 pcs.	1 pallet = 3200 pcs.	9.80 kg
100279	V4A stainless steel, 2-part, flat/round, heavy duty version, M10 screws	1 carton of 50 pcs.	1 pallet = 3200 pcs.	9.35 kg
100282	V2A stainless steel, 2-part, round/round heavy duty version, M10 screws	1 carton of 50 pcs.	1 pallet = 3200 pcs.	9.55 kg
100285	V4A stainless steel, 2-part, round/round heavy duty version, M10 screws	1 carton of 50 pcs.	1 pallet = 3200 pcs.	9.35 kg

Galvanised double clamps

for earthing strap up to 40 mm width and round conductors $\varnothing 8 + 10$ mm

Art.Gr.
513

Art. no.	Description	PU	Secondary packaging	Weight per carton
100220	Galvanised steel, 2-part, flat/flat, heavy duty version, M10 screws	1 carton of 50 pcs.	1 pallet = 3200 pcs.	12.15 kg
100225	Galvanised steel, 2-part, flat/round, heavy duty version, M10 screws	1 carton of 50 pcs.	1 pallet = 3200 pcs.	11.60 kg
100230	Galvanised steel, 2-part, round/round, heavy duty version, M10 screws	1 carton of 50 pcs.	1 pallet = 3200 pcs.	11.70 kg

Possible clamping connections

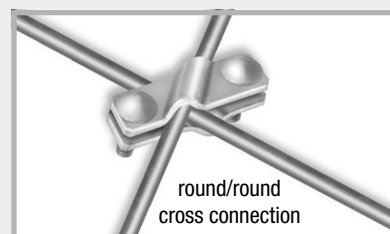
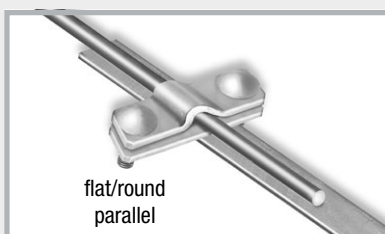
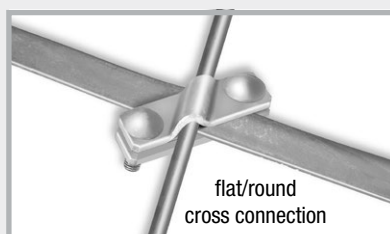
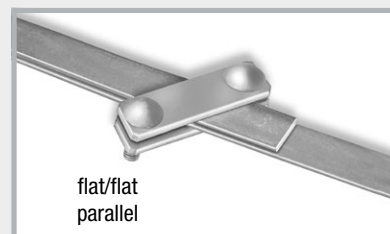
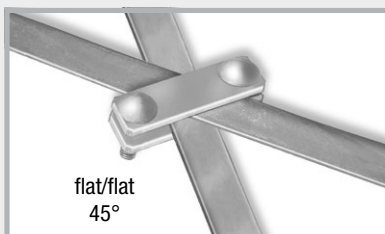
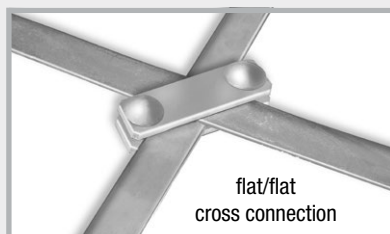

Art.Gr.
514

Single clamps

Art. no.	Description	PU	Secondary packaging	Weight per carton
100163	Galvanised steel , 1 M10 screw, for flat conductors up to 30 mm and round conductors \varnothing 8+ 10 mm, for T, cross and parallel connections	1 carton of 50 pcs.	1 pallet = 3200 pcs.	6.40 kg
100162	V4A stainless steel , 1 M10 screw, for flat conductors up to 30 mm and round conductors \varnothing 8+ 10 mm, for T, cross and parallel connections	1 carton of 50 pcs.	1 pallet = 3200 pcs.	5.25 kg

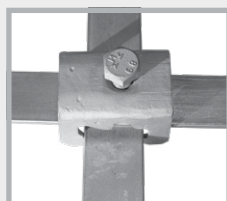
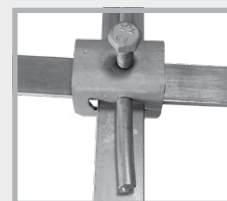

Single clamp

flat/flat
parallel connectionflat/flat
cross connectionflat/round
parallel connectionflat/flat/round
connection

Parallel connectors

Art.Gr.
514

Art. no.	Description	PU	Secondary packaging	Weight per carton
100240	Galvanised steel , 1 M10 screw, 2-part, for round conductors \varnothing 8 + 10 mm	1 carton of 50 pcs.	1 pallet = 5600 pcs.	7.35 kg
100243	V4A stainless steel , 1 M10 screw, 2-part, for round conductors \varnothing 8 + 10 mm	1 carton of 50 pcs.	1 pallet = 5600 pcs.	6.05 kg

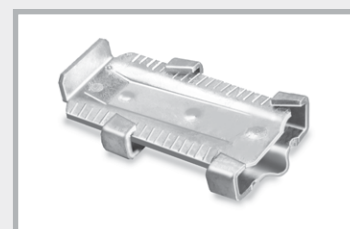
Art.Gr.
514

Wedge connector

Art. no.	Description	PU	Secondary packaging	Weight per carton
100160	Galvanised steel , for round conductors \varnothing 10 mm and flat conductors up to 40 mm, with lock-in position in the wedge	1 carton of 50 pcs.	1 pallet = 3200 pcs.	10.90 kg

Fixed earthing terminal M10/M12

to connect the equipotential bonding conductors to the ring electrode, reinforcement and lightning protection system

Art.Gr. 519



Art. no.	Description	PU	Weight per carton	
100187	Fixed earthing terminal M10/M12, V4A stainless steel, without axis, with yellow protective cap, connection M10 + M12	1 carton of 10 pcs.	1.60 kg	
100195	Fixed earthing terminal M10/M12 "Safe", without axis, with yellow protective cap and waterstop, connection M10 + M12	1 carton of 10 pcs.	2.00 kg	
100202	Fixed earthing terminal M10/M12, V4A stainless steel, with mounted, galvanised axis, Length 200 mm, with yellow protective cap	1 carton of 10 pcs.	2.90 kg	
100200	Fixed earthing terminal M10/M12, V4A stainless steel, with mounted A2 multi-purpose connecting clamp, with yellow protective cap	1 carton of 10 pcs.	2.40 kg	

Installation

Art. no. 100187

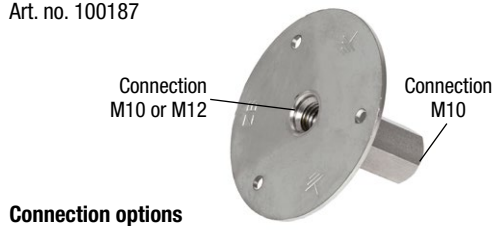

Installation



M10 "Solo" axes for fixed earthing terminal

Art.Gr. 521

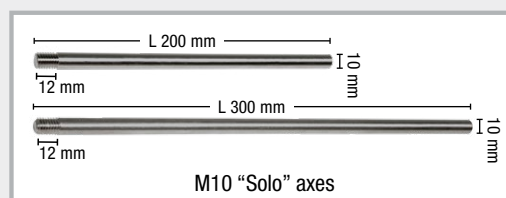

Art. no.	Description	PU	Weight/carton
100183	galvanised, length 200 mm	Carton of 50 pcs.	6.00 kg
100185	galvanised, length 300 mm	Carton of 50 pcs.	9.50 kg
100184	V4A stainless steel, length 200 mm	Carton of 50 pcs.	6.00 kg
100186	V4A stainless steel, length 300 mm	Carton of 50 pcs.	9.00 kg



M10 "Safe" axes for pressure water-tight fixed earthing terminal

Art.Gr. 521

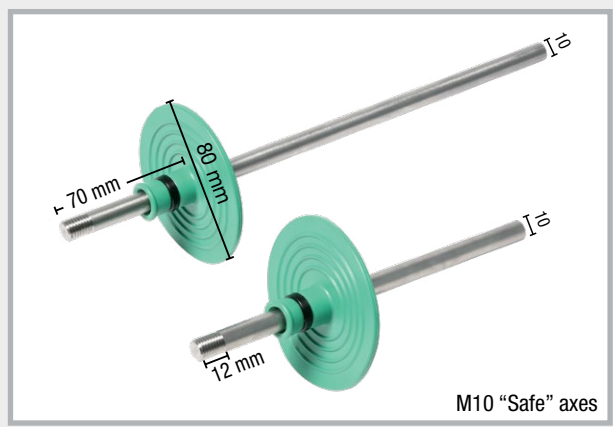

M10 "Safe" axes

Art. no.	Description	PU	Weight/pc.
100177	galvanised, length 200 mm	1 pc.	0.15 kg
100178	galvanised, length 300 mm	1 pc.	0.22 kg
100179	V4A stainless steel, length 200 mm	1 pc.	0.15 kg
100180	V4A stainless steel, length 300 mm	1 pc.	0.21 kg



Fixed earthing terminal with "Safe" axis

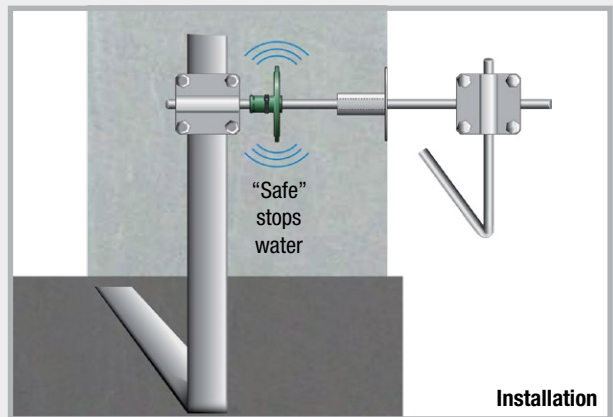

Installation

Cross clamps for fixed earthing terminals M10/12

Art.Gr. 522

Art. no.	Description	PU	Weight per carton	Art. no. 100188 Art. no. 100189
100188	Cross clamp for fixed earthing terminal M10/12, galvanised, M10 thread, Thread length 70 mm, for round conductors Ø 8 + 10 mm and flat conductors up to 40 mm	Carton of 10 pcs.	3.80 kg	<p>Thread length 70 mm M10</p>
100189	Cross clamp for fixed earthing terminal M10/12, V4A stainless steel, M10 thread, Thread length 70 mm, for round conductors Ø 8 + 10 mm and flat conductors up to 40 mm	Carton of 10 pcs.	3.20 kg	<p>Installation Fixed earthing terminal with screwed in cross clamp. Round and flat conductors can be connected.</p>

M10 “Safe” wall bushings with pre-assembled fixed earthing terminals

The M10 wall bushings are pre-assembled and supplied in the exact wall thickness. Time-consuming adjustments are not necessary.

Fixed earthing terminal: V4A stainless steel, connection axes 10 mm: stainless steel

Art.Gr. 520

Wall thickness	Art. no.	Weight/pc.
200 mm	100394	0.42 kg
240 mm	100396	0.45 kg
250 mm	100398	0.45 kg
300 mm	100400	0.48 kg
350 mm	100402	0.52 kg
365 mm	100404	0.53 kg
400 mm	100406	0.55 kg

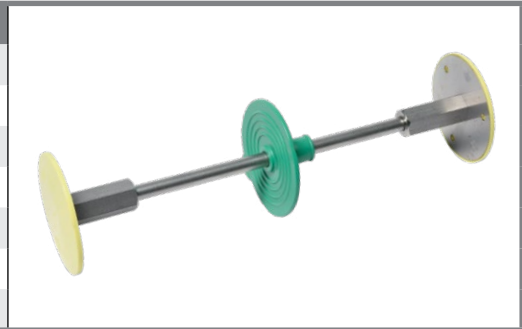

M10 connection axis “Safe” for wall bushings

Stainless steel, diameter 10 mm, M10 thread at both ends, length of thread 12 mm

Art.Gr. 521

Wall thickness	Art. no.	Weight/pc.
200 mm	100360	0.10 kg
240 mm	100365	0.13 kg
250 mm	100370	0.13 kg
300 mm	100375	0.16 kg
350 mm	100380	0.20 kg
365 mm	100385	0.21 kg
400 mm	100390	0.23 kg



M10 “Solo” wall bushings with pre-assembled fixed earthing terminals

The M10 wall bushings are pre-assembled and supplied in the exact wall thickness. Time-consuming adjustments are not necessary.

Fixed earthing terminal: V4A stainless steel, connection axes: 10 mm: stainless steel

Art.Gr. 520

Wall thickness	Art. no.	Weight/pc.
200 mm	100444	0.40 kg
240 mm	100446	0.42 kg
250 mm	100448	0.43 kg
300 mm	100450	0.46 kg
350 mm	100452	0.49 kg
365 mm	100454	0.50 kg
400 mm	100456	0.52 kg



M10 connection axis "Solo" for wall bushings

Stainless steel, diameter 10 mm, M10 thread at both ends, length of thread 12 mm

Art.Gr.
521

Wall thickness	Art. no.	Weight/pc.
200 mm	100410	0.07 kg
240 mm	100415	0.10 kg
250 mm	100420	0.10 kg
300 mm	100425	0.14 kg
350 mm	100430	0.17 kg
365 mm	100435	0.18 kg
400 mm	100440	0.20 kg

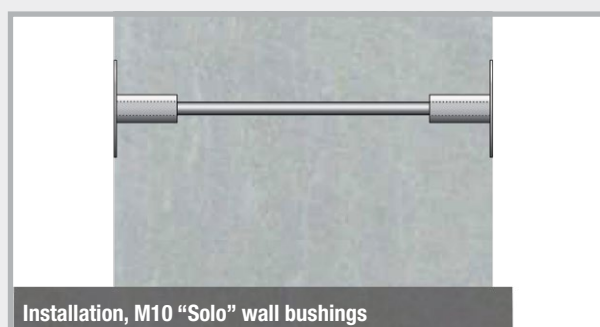
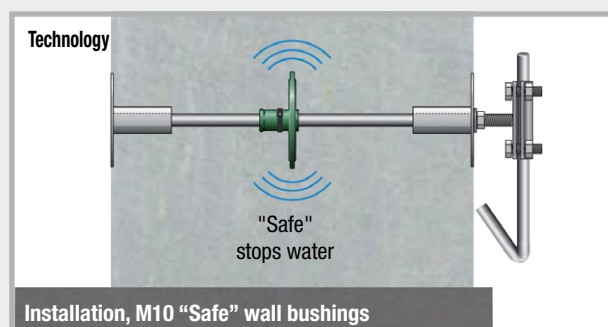

NEW! Wall bushings (N)

For subsequent installation of earthing conductors in borehole \varnothing 14 mm or distance tube. Threaded rod with fixed/loose flange made of V4A stainless steel, connecting clamp and nuts made of galvanised steel.

Art.Gr.
534

Wall thicknesses	Art. no.	PU	Weight per pc.
100-300 mm	100310	1 set	0.66 kg
300-500 mm	100315	1 set	0.80 kg

Inside connection options: Round conductors with pre-installed multi-purpose connecting clamp; flat conductors with double clamp page 150: This clamp can be installed in place of the multi-purpose connecting clamp at the construction site.

Inside connection

Outside connection M12

Outside connection options: Cross clamp M12, page 158; M12 "Solo" axes page 157

Description	Art. no.	PU	Weight/pc.
Connection terminal for wall bushing (N), galvanised Connection: Threaded rod on multi-purpose connecting clamp, M10 screw, for round conductors 8-10 mm, with borehole \varnothing 13 mm	100181	1 pc.	0.14 kg

Gasket insert for round conductors, core drill hole 50 mm

Pressure water-tight lead-in with the MASTER-RING gasket insert

Art.Gr.
440

Art. no.	Description	PU	Weight/pc.
120080	Gasket insert for round conductors 8 + 10 mm, Core drill hole \varnothing 50 mm, Medium pipe 6-12 mm	1 pc.	0.38 kg



Wall bushing, flexible

Flexible wall bushing M10

for height-offset and side-shifted offset positioning of earthing connections,
fixed earthing terminal in V4A stainless steel, steel cable \varnothing 10 mm

Art.Gr.
520

Art. no.	Description	PU	Weight/pc.
100660	Wall bushing, flexible 600 mm, 2 x fixed earthing terminal with connecting clamp 1 x steel cable length 600 mm	1 pc.	0.70 kg
100662	Wall bushing, flexible 1200 mm, 2 x fixed earthing terminal with connecting clamp 1 x steel cable length 1200 mm	1 pc.	0.93 kg

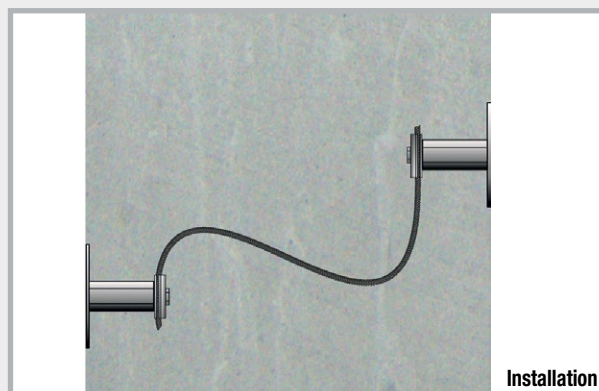

Wall bushing, flexible "Safe"

Flexible wall bushing M10,

sealed pressure water-tight with RONDO EFP,

for height-offset and side-shifted offset positioning of earthing connections

Art.Gr.
520

Art. no.	Description	PU	Weight/pc.
100670	Wall bushing, flexible 600 mm "Safe" 2 x fixed earthing terminal with connecting clamp and RONDO EFP 1 x steel cable length 600 mm	1 pc.	0.77 kg
100672	Wall bushing, flexible 1200 mm 2 x fixed earthing terminal with connecting clamp and RONDO EFP 1 x steel cable length 1200 mm	1 pc.	1.00 kg

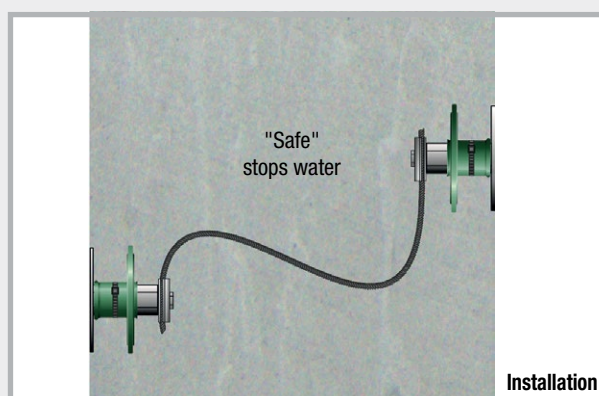

Fixed earthing terminal M12

to connect the equipotential bonding conductors to the ring earth electrode, reinforcement and lightning protection system

Art.Gr.
523



Art. no.	Description	PU	Weight per carton	
100300	Fixed earthing terminal M12, V4A stainless steel, with yellow protective cap, Connection M12	1 carton of 10 pcs.	2.00 kg	
100304	Fixed earthing terminal M12 "Safe" with yellow protective cap and waterstop, Connection M12	1 carton of 10 pcs.	2.40 kg	
100308	Connecting plate 40 x 4 mm, incl. screw M12 x 25	1 carton of 10 pcs.	1.90 kg	
100312	Fixed earthing terminal M12 with connecting plate and yellow protective cap, Connection M12	1 carton of 10 pcs.	3.90 kg	
100316	Fixed earthing terminal M12 "Safe" with connecting plate and yellow protective cap, Connection M12	1 carton of 10 pcs.	4.30 kg	

Technology

Art. no. 100300

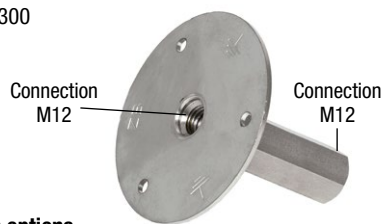

Connection options

Art. no. 100316

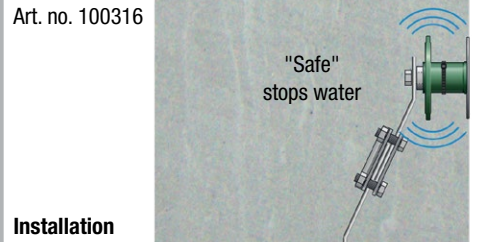

Installation

M12 "Solo" axes for fixed earthing terminal

Art.Gr.
524

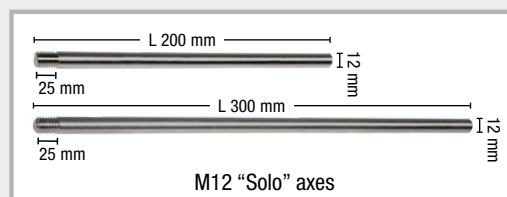

Art. no.	Description	PU	Weight/carton
101170	galvanised, length 200 mm	1 carton of 50 pcs.	8.50 kg
101172	galvanised, length 300 mm	1 carton of 50 pcs.	13.00 kg
101174	V4A stainless steel, length 200 mm	1 carton of 50 pcs.	9.00 kg
101176	V4A stainless steel, length 300 mm	1 carton of 50 pcs.	13.00 kg

M12 "Safe" axes for pressure water-tight fixed earthing terminal



Art.Gr. 524

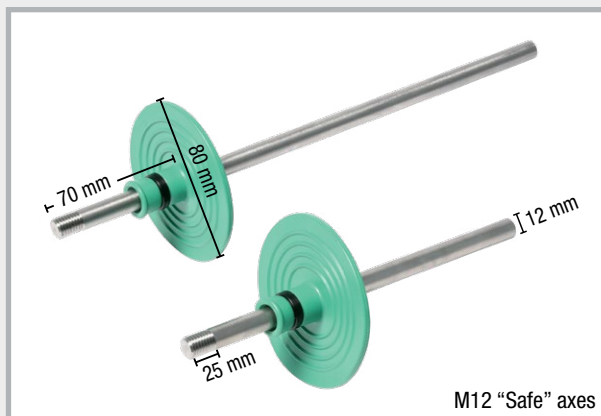

M12 "Safe" axes

Art. no.	Description	PU	Weight/pc.
101180	galvanised, length 200 mm	1 pc.	0.20 kg
101182	galvanised, length 300 mm	1 pc.	0.29 kg
101184	V4A stainless steel, length 200 mm	1 pc.	0.20 kg
101186	V4A stainless steel, length 300 mm	1 pc.	0.29 kg

Crossclamps for fixed earthing terminals M12

Art.Gr. 525

Art. no.	Description	PU	Weight/carton
100460	Cross clamp for fixed earthing terminal M12, galvanised, M12 thread, thread length 70 mm, for round conductors Ø 8 + 10 mm and flat conductors up to 40 mm	1 carton of 10 pcs.	4.20 kg
100462	Cross clamp for fixed earthing terminal M12, V4A stainless steel, M12 thread, thread length 70 mm, for round conductors Ø 8 + 10 mm and flat conductors up to 40 mm	1 carton of 10 pcs.	3.45 kg
100464	Cross clamp for fixed earthing terminal M12, V4A stainless steel M12 thread, thread length 200 mm, for round conductors Ø 8 + 10 mm and flat conductors up to 40 mm	1 carton of 10 pcs.	4.50 kg



M12 “Safe” wall bushings with fixed earthing points pre-assembled

The M12 wall bushings are pre-assembled and supplied in the exact wall thickness.

Time-consuming adjustments are not necessary.

Fixed earthing terminal: stainless steel V4A,

connection axes 12 mm: stainless steel

incl. connecting plate 4 x 40 mm

Art.Gr.
526

Wall thickness	Art. no.	Weight/pc.
200 mm	100334	0.68 kg
240 mm	100336	0.72 kg
250 mm	100338	0.73 kg
300 mm	100340	0.78 kg
350 mm	100342	0.82 kg
365 mm	100344	0.83 kg
400 mm	100346	0.87 kg

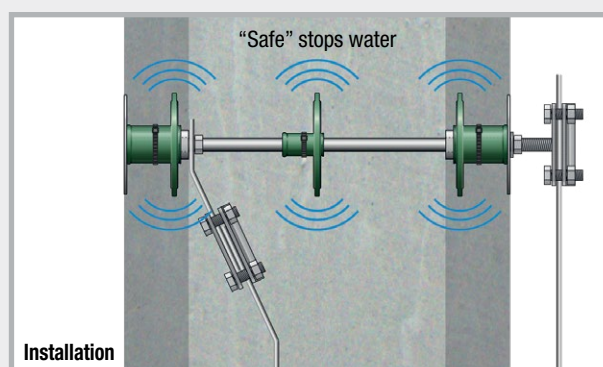
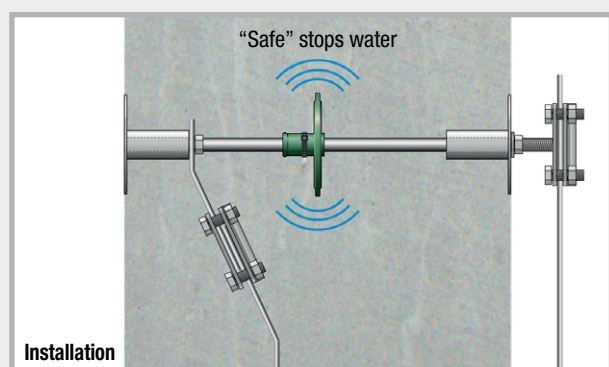
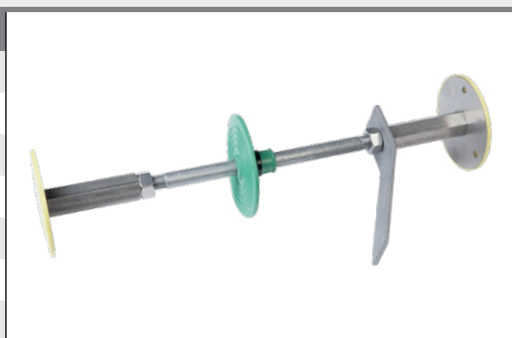

M12 “DW Safe” wall bushings with fixed earthing points pre-assembled

The M12 wall bushings are pre-assembled and supplied in the exact wall thickness.

Time-consuming adjustments are not necessary.

Fixed earthing terminal: stainless steel V4A,

connection axes 12 mm: stainless steel

incl. connecting plate 4 x 40 mm

Art.Gr.
526

Wall thickness	Art. no.	Weight/pc.
200 mm	100348	0.76 kg
240 mm	100350	0.80 kg
250 mm	100352	0.81 kg
300 mm	100354	0.85 kg
350 mm	100356	0.90 kg
365 mm	100358	0.91 kg
400 mm	100359	0.94 kg



M12 connection axis "Solo" for wall bushings

Stainless steel, diameter 12 mm,
M12 thread at both ends, length of thread 45 mm,
incl. 2 lock nuts

Art.Gr.
524

Art. no.	Wall thickness	PU	Weight per pc.
100320	200 mm	1 pc.	0.10 kg
100322	240 mm	1 pc.	0.14 kg
100324	250 mm	1 pc.	0.15 kg
100326	300 mm	1 pc.	0.19 kg
100328	350 mm	1 pc.	0.24 kg
100330	365 mm	1 pc.	0.25 kg
100332	400 mm	1 pc.	0.28 kg

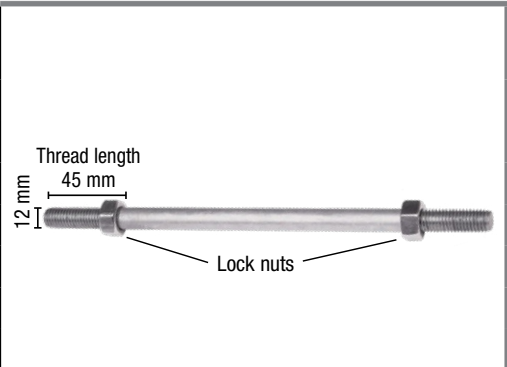

Fixed earthing terminal M16 and accessories

to connect the equipotential bonding conductors to the foundation earth electrode, reinforcement and lightning protection system

Art. no.	Description	PU	Weight per pc.
100455	Fixed earthing terminal M16, V4A stainless steel, without axis, with yellow protective cap, Connection M16 <small>Art.Gr. 527</small>	1 carton of 10 pcs.	1.70 kg per carton
100461	Fixed earthing terminal M16, V4A stainless steel, with flexible connection conductor, Connection conductor CU/SN 95 mm², Conductor length 400 mm <small>Art.Gr. 527</small>	1 pc.	0.66 kg
100458	Cross clamp for fixed earthing terminal M16, V4A stainless steel, M16 thread, Thread length 30 mm, for round conductors Ø 8 + 10 mm and flat conductors up to 40 mm <small>Art.Gr. 528</small>	1 carton of 10 pcs.	3.10 kg per carton

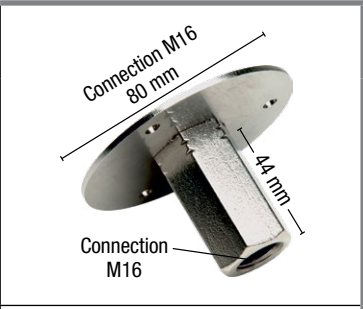
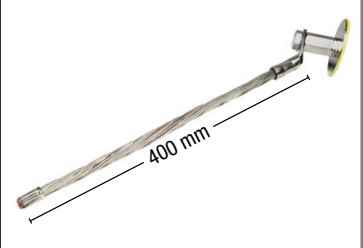
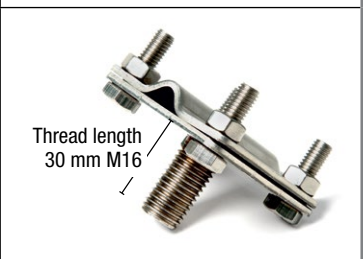
Art.Gr.
529

Accessories for fixed earthing terminal

Art. no.	Description	PU	Weight per pc.	
100198	Plastic foam for fixed earthing terminal, self-adhesive on one side, Ø 76 mm, thickness 20 mm	1 bag of 10 pcs.	0.08 kg	
100196	Fixing spider for fixed earthing terminal, steel/bright	1 pc.	0.12 kg	

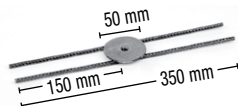

1
Remove protective cap of fixed earthing terminal



2
Stick on plastic foam

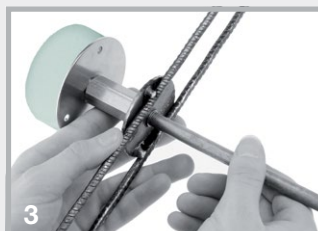

3
Screw axis through the fixing spider and fasten fixed earthing terminal

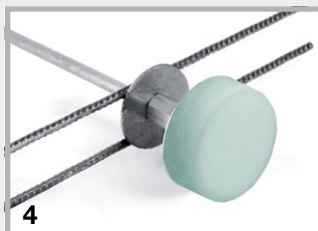

4
Installation complete

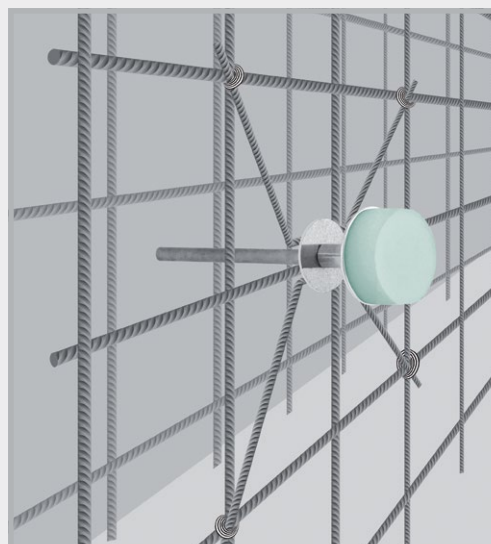



Fixed earthing terminal with fixing spider on the reinforcement

FIX formwork aid

NEW! Fastening systems for fixed earthing terminals in precast concrete plants

Art.Gr.
420

Fastening to steel formworks using the FIX Magnet

Art. no.	Description	PU	Weight/pc.	
091410	FIX Magnet for formwork aid Power Magnet for all FIX formwork aids, incl. screw and wing nut	25 pcs.	0.14 kg	
090804	FIX EFP formwork aid for fixed earthing terminals M10/12 and M12 Cone height 11 mm	25 pcs.	0.03 kg	

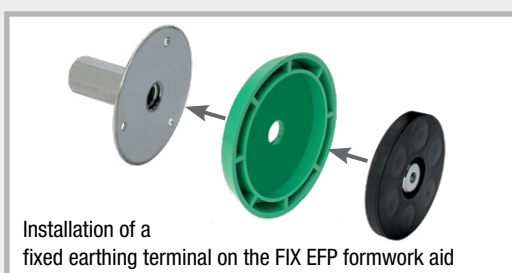

Installation of a fixed earthing terminal on the FIX EFP formwork aid

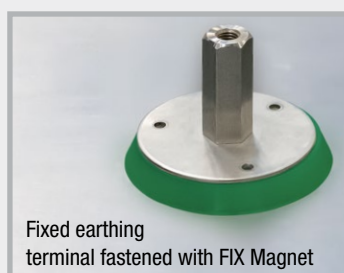

Fixed earthing terminal fastened with FIX Magnet



Option for connection to the fixed earthing terminal, for example with axis and clamp

MultiCap

Protective cap
to DIN 18014

PVC protective cap for round and flat conductors

Art.Gr.
530



Art. no.	Description	PU	Weight/bag
100500	MultiCap , colour: yellow, area of application: round conductor: 8 + 10 mm flat conductor: 30 x 3.5 mm 40 x 4.0 mm 30 x 3.0 mm 40 x 5.0 mm	1 bag of 100 pcs.	5.15 kg

Technical data

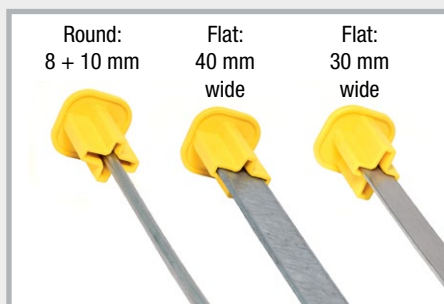
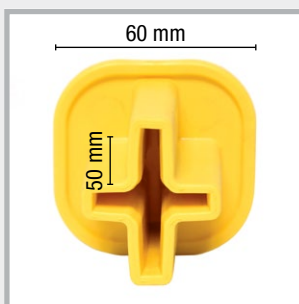

Material: PVC,
 Large labelled safety cap,
 60 x 60 mm,
 long mounting slot
 50 mm

Round: 8 + 10 mm
 Flat: 40 mm wide
 Flat: 30 mm wide

MultiCap can be used universally



Description

- No risk of injury
- Simply plug on
- Yellow signal colour
- One protection cap for 6 sizes

Excerpt from DIN 18014

Foundation earth electrode:

For safety reasons, the terminal lugs must be prominently marked during the construction phase.

Terminal lugs

Round conductor rods, bevelled

Art.Gr.
531

Art. no.	Description	Length	PU	Weight per bundle	
100555	V4A stainless steel round conductor Ø 10 mm	1.50 m	1 bundle of 10 pcs.	9.40 kg	
100560	V4A stainless steel round conductor Ø 10 mm	2.00 m	1 bundle of 10 pcs.	12.50 kg	
100565	V4A stainless steel round conductor Ø 10 mm	2.50 m	1 bundle of 10 pcs.	15.70 kg	
100570	V4A stainless steel round conductor Ø 10 mm	3.00 m	1 bundle of 10 pcs.	18.60 kg	

RONDO Standard



Sealing collars for lightning protection wire and earthing strap

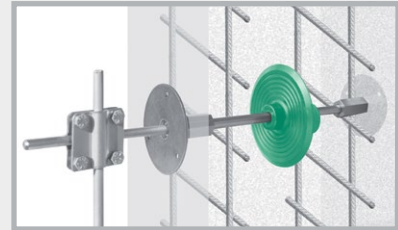

RONDO sealing collars form pressure water-tight seals for lightning protection wires and earthing straps passing through concrete walls, floor slabs and shafts.

Art.Gr.
400



Art. no.	Description	PU	Secondary packaging	Weight per pc.	
090890	RONDO RO 10, for lightning protection conductors Ø 8 + 10 mm	1 pc.	1 carton of 100 pcs.	0.12 kg	
090892	RONDO RO flat, for earthing strap 30x3.5 + 30x3.0 mm	1 pc.		0.18 kg	
090988	RONDO EFP, for hexagon fixed earthing terminal	1 pc.	1 bag of 25 pcs.	0.04 kg	



The sealing collars are supplied with fastening straps, ready for installation

Accessories

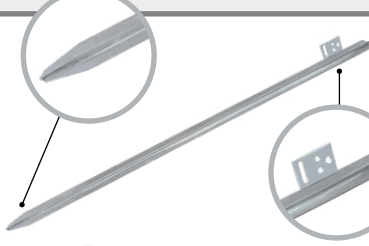
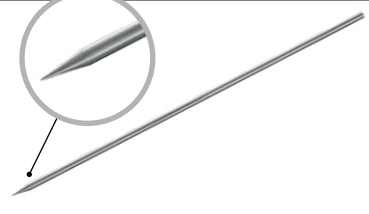
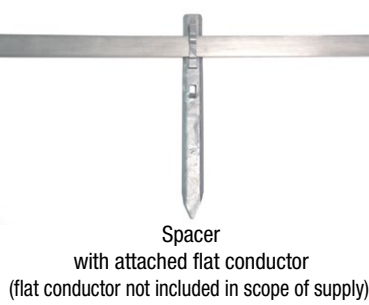
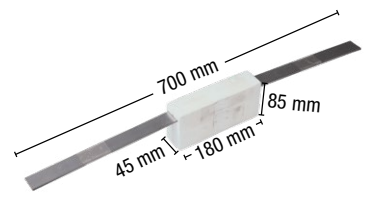
Art. no.	Description	PU	Weight per pc.	
100165	Profiled earth rod, Length: 1.5 m, galvanised, cross profile 50 x 50 mm, with terminal lug	1 pc.	3.40 kg	
NEW! 100206	Earth rod for the construction site, Length 1.2 m, Ø 20 mm, galvanised, with impact tip, Connection with clamps from the earth rod range	1 pc.	2.86 kg	
100170	Spacer for foundation earth electrode, galvanised, for round connector Ø 8-10 mm, earthing strap 30 x 3.5 mm, length 280 mm, installation spacing 1-1.5 m	1 carton of 100 pcs.	9.80 kg per carton	 Spacer with attached flat conductor (flat conductor not included in scope of supply)
100176	Expansion strip with polystyrene body, V2A stainless steel, for routing of foundation earth electrode through expansion joints	1 pc.	0.70 kg	 700 mm 45 mm 180 mm 85 mm

Anti-corrosive tapes

for wrapping of overground and underground connections

Art. no.	Description	PU	Weight per roll	
100190	Anti-corrosive tapes, Roll length 10 m certified by DVGW Size: 1.5 x 50 mm	1 carton of 24 rolls	0.71 kg	
100193	Size: 1.5 x 100 mm	1 carton of 12 rolls	1.20 kg	

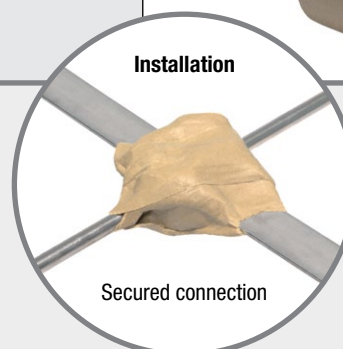

Earth rod

for use in earthing systems

Art.Gr.
533

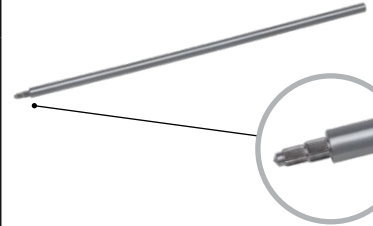
Art. no.	Design	PU	Weight per pc.	
100205	Earth rod for the installation of earthing systems, galvanised, Length 1500 mm, Ø 20 mm	1 pc.	3.60 kg	
100210	Earth rod for the installation of earthing systems, V4A stainless steel, Length 1500 mm, Ø 20 mm	1 pc.	3.70 kg	 The earth rods have a drilled hole on one side and a pin on the other. This produces a self-closing coupling.
100215	Impact tip for driving in the first earth rod, bright steel	1 pc.	0.04 kg	
100216	Drive-in aid for earth rod, bright steel	1 pc.	0.48 kg	
100218	Connecting clamp for earth rod, galvanised, heavy duty version with M10 screws for round conductors Ø 8 + 10 mm and flat conductors up to 40 mm	1 pc.	0.38 kg	
100217	Connecting clamp for earth rod V4A stainless steel, heavy duty version with M10 screws for round conductors Ø 8 + 10 mm and flat conductors up to 40 mm	1 pc.	0.30 kg	 Connecting clamp installed

Basic principles of the installation of lightning protection conductors and connectors

FOUNDATION EARTH ELECTRODE

Installation location: In the concrete of the foundation and floor slab with minimum 5 cm concrete cover on all sides

Material: Galvanised or non-galvanised steel as flat conductor 30 x 3.5 mm or round conductor DN 10 mm

CONNECTION PARTS ON FOUNDATION EARTH ELECTRODE

Installation location: In subsoil

Material: A4 stainless steel material grades 1.4401, 1.4404, 1.4571
Flat conductor 30 x 3.5 mm or round conductor DN 10 mm

RING EARTH ELECTRODE AND CONNECTION PARTS ON RING EARTH ELECTRODE

Installation location: Outside the foundation in the subsoil

Material: A4 stainless steel material grades 1.4401, 1.4404, 1.4571 as
30 x 3.5 mm flat conductor or DN 10 mm round conductor
Galvanised material is not permitted in this area

CONNECTORS

Installation location: In subsoil, connector made of A4 stainless steel, galvanised in foundation

Description: Wedge connectors are not permitted: unless installed in non-vibrated concrete
4 x M6 screws above ground only and for arrester lines and down conductors
4 x M8 or 2 x M10 screws and M10 multi-purpose connecting clamp for use in the following areas: subsoil, concrete, above ground, down conductors and arrester lines.

DIN STANDARDS DIN EN 62561-1 and 62561-2

COSTS The cost of stainless steel round conductors is up to 33% less than stainless steel flat conductors. The round conductor, which can be installed as an alternative to the flat conductor, is easier to handle and therefore has a significantly higher workability.

FORMWORK ACCESSORIES



**STOPPER SCREW +
STOPPER**

pages 169 – 170

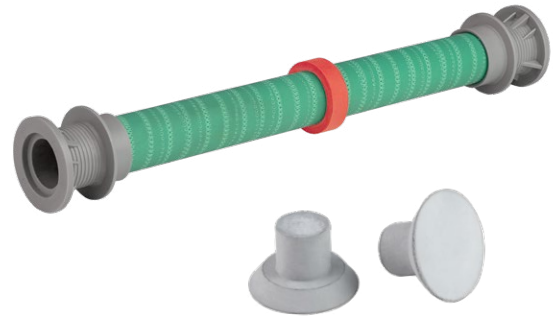

**STOPPER distance tube +
STOPPER sealing cone**

pages 171 – 172



RONDO MINI + ActiveRings

page 172

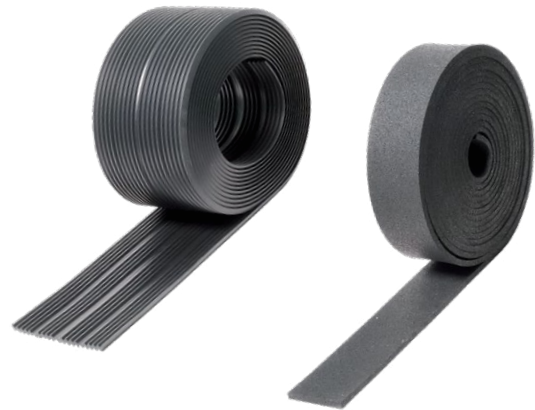

**Corrugated bearings +
impact sound insulation**

page 173

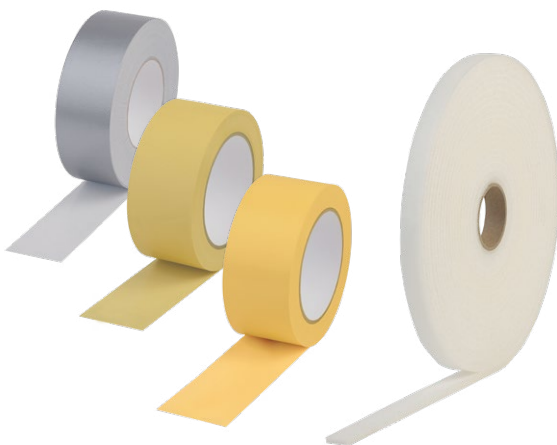

KLEBO tapes

page 174



Damp proof courses

page 175

WATERPROOFING TECHNOLOGY

for inner and outer waterproofing of plastic or fibre cement formwork tie points and conical anchor holes

STOPPER SCREW



Screwed sealing of formwork tie points – maximum safety with superb appearance

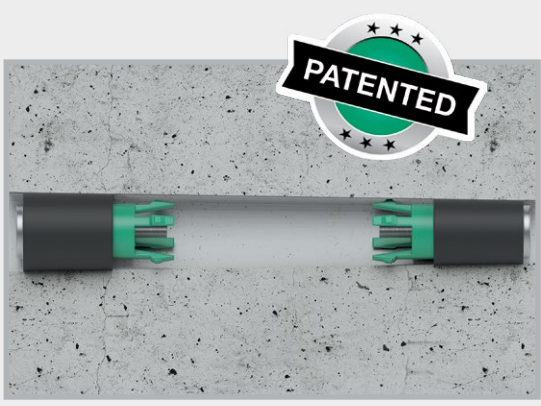

STOPPER



Inner seals for plastic and fibre cement distance tubes



RONDO MINI



Sealing collars for waterproofing of plastic or fibre cement distance tubes



ActiveRing



The swelling external high-pressure seal for plastic and fibre cement distance tubes



STOPPER SCREW



Technical details page 176

STOPPER SCREW type in



Art.Gr.
611



Art. no.	Description	Tie point inner diameter	PU per bucket	Secondary packaging	Weight per PU
046230	STOPPER SCREW 17 · type 3 in Total length: 72 mm	17 to 19.5 mm	100 pcs. incl. 2 bits	1 pallet = 55 buckets	2.80 kg
046240	STOPPER SCREW 20 · type 4 in Total length: 72 mm	19.5 to 22 mm	100 pcs. incl. 2 bits	1 pallet = 55 buckets	3.20 kg
046210	STOPPER SCREW 22 · type 1 in Total length: 72 mm	21.5 to 23 mm	100 pcs. incl. 2 bits	1 pallet = 55 buckets	3.60 kg
046220	STOPPER SCREW 23 · type 2 in Total length: 72 mm	22.3 to 25.4 mm	100 pcs. incl. 2 bits	1 pallet = 55 buckets	4.00 kg
046250	STOPPER SCREW 25 · type 5 in Total length: 72 mm	25 to 28 mm	100 pcs. incl. 2 bits	1 pallet = 55 buckets	4.80 kg
046270	STOPPER SCREW 28 · type 7 in Total length: 72 mm	27.5 to 29 mm	100 pcs. incl. 2 bits	1 pallet = 55 buckets	5.10 kg
046260	STOPPER SCREW 31 · type 6 in Total length: 80 mm	31 to 34 mm	50 pcs. incl. 2 bits	1 pallet = 55 buckets	3.80 kg

STOPPER SCREW type covered



Art.Gr.
611

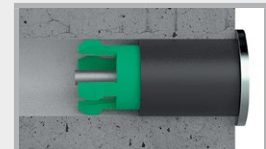

Art. no.	Description	Tie point inner diameter	PU per bucket	Secondary packaging	Weight per PU
046330	STOPPER SCREW 17 · type 3 covered Cover plate: 28 mm, total length: 75 mm	100 pcs. incl. 2 bits	100 pcs. incl. 2 bits	1 pallet = 55 buckets	3.85 kg
046340	STOPPER SCREW 20 · type 4 covered Cover plate: 28 mm, total length: 75 mm	100 pcs. incl. 2 bits	100 pcs. incl. 2 bits	1 pallet = 55 buckets	4.30 kg
046310	STOPPER SCREW 22 · type 1 covered Cover plate: 28 mm, total length: 75 mm	100 pcs. incl. 2 bits	100 pcs. incl. 2 bits	1 pallet = 55 buckets	4.80 kg
046320	STOPPER SCREW 23 · type 2 covered Cover plate: 32 mm, total length: 75 mm	100 pcs. incl. 2 bits	100 pcs. incl. 2 bits	1 pallet = 55 buckets	5.40 kg
046350	STOPPER SCREW 25 · type 5 covered Cover plate: 32 mm, total length: 75 mm	100 pcs. incl. 2 bits	100 pcs. incl. 2 bits	1 pallet = 55 buckets	6.30 kg
046370	STOPPER SCREW 28 · type 7 covered Cover plate: 32 mm, total length: 75 mm	100 pcs. incl. 2 bits	100 pcs. incl. 2 bits	1 pallet = 55 buckets	6.60 kg
046360	STOPPER SCREW 31 · type 6 covered Cover plate: 38.5 mm, total length: 83 mm	50 pcs. incl. 2 bits	50 pcs. incl. 2 bits	1 pallet = 55 buckets	4.80 kg

Accessories

Art. no.	Description	PU	Weight per pc.	
046170	Hand-held cleaning brush Tie points of 17 – 34 mm	1 pc.	0.08 kg	
NEW! 046171	Mechanical cleaning brush Tie points of 17 – 34 mm for drills or cordless screwdrivers	1 pc.	0.06 kg	
NEW! 046183	STOPPER SCREW torque set 1 x torque bit holder, 2 x bits TX 20	1 set	0.04 kg	

STOPPER

Inner seals for plastic and fibre cement distance tubes



Technical details pages 177 – 178



Art.Gr. **610**

Art. no.	Description	PU	Secondary packaging	Weight per bucket
046140	STOPPER in 22 for distance tubes inner diameter 21.5-23 mm	Bucket of 250 pcs.	1 pallet = 48 buckets	6.50 kg
046150	STOPPER mini 22 for distance tubes inner diameter 21.5-23 mm	Bucket of 250 pcs.	1 pallet = 48 buckets	6.75 kg
046160	STOPPER maxi 22 for distance tubes inner diameter 21.5-23 mm	Bucket of 250 pcs.	1 pallet = 32 buckets	9.25 kg
046163	STOPPER in 26 for distance tubes inner diameter 26 mm	Bucket of 250 pcs.	1 pallet = 32 buckets	10.75 kg
046170	Hand-held cleaning brush Tie points of 17 – 34 mm	1 pc.		0.08 kg per pc.
NEW! 046171	Mechanical cleaning brush Tie points of 17 – 34 mm for drills or cordless screwdrivers	1 pc.		0.06 kg per pc.
046180	Drive-in aid for STOPPER 22 + 26 mm	1 pc.		0.08 kg per pc.



Use a 1500-2000 g hard rubber hammer to drive in the STOPPER.

Product description

- STOPPERS are drive-in plugs which were developed for pressure-tight sealing of fibre cement and plastic distance tubes.
- Highly resistant plastic specially developed for this application
- Temperature range -35°C to +70°C; if the plugs are installed at ambient temperatures below 0°C, they must be stored above freezing point beforehand for a better installation.
- All-weather installation
- Seals immediately after driving in
- Little storage space required



STOPPER distance tube



Pressure water-tight plastic distance tube with cone (Ø 22 mm) on both sides

Technical details page 179

- Pressure water-tight transition to the concrete
- Ready-to-install delivery for all common wall thicknesses
- Special lengths available at short notice or can be produced on site
- Pressure water-tight system sealing for internal closure with:
 - STOPPER in / mini 30 m water column
 - STOPPER SCREW 70 m water column

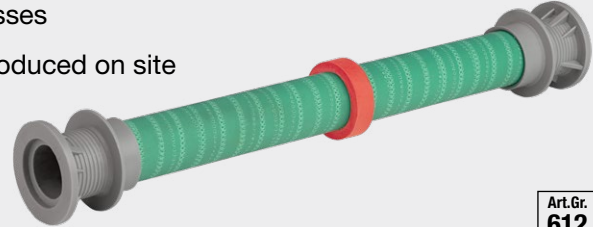

Art.Gr.
612

Art. no.	Description	PU	Secondary packaging	Weight per 100 pcs.
048200	STOPPER distance tube 22/200 Ø 22 mm, length 200 mm	100 pcs.	1 pallet = 18 bags	5.30 kg
048240	STOPPER distance tube 22/240 Ø 22 mm, length 240 mm	100 pcs.	1 pallet = 16 bags	6.00 kg
048250	STOPPER distance tube 22/250 Ø 22 mm, length 250 mm	100 pcs.	1 pallet = 16 bags	6.00 kg
048300	STOPPER distance tube 22/300 Ø 22 mm, length 300 mm	100 pcs.	1 pallet = 16 bags	6.80 kg
048350	STOPPER distance tube 22/350 Ø 22 mm, length 350 mm	100 pcs.	1 pallet = 14 bags	7.60 kg
048365	STOPPER distance tube 22/365 Ø 22 mm, length 365 mm	100 pcs.	1 pallet = 14 bags	7.70 kg
048400	STOPPER distance tube 22/400 Ø 22 mm, length 400 mm	100 pcs.	1 pallet = 12 bags	8.20 kg

Other lengths are available at short notice.

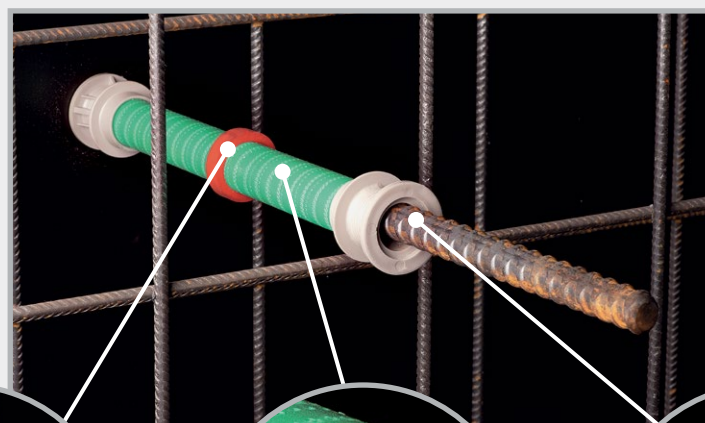

Ready-to-install delivery for all common wall thicknesses.

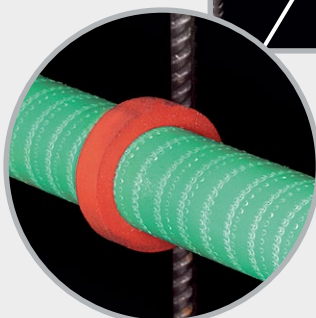

Pressure water-tight concrete transition thanks to ActiveRing

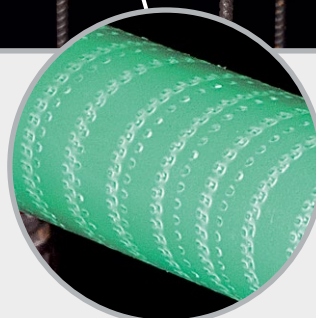

Roughened tube surface for optimum concrete bond



For anchor bars Ø 15/17 mm

STOPPER sealing cone

Fibre cement cone for bonding for a visually appealing distance tube closure [Technical details page 179](#)

Art.Gr.
610

Art. no.	Description	PU	Secondary packaging	Weight per carton	
046200	STOPPER sealing cone Ø 22 mm	Carton of 100 pcs.	1 pallet = 40 cartons	2.97 kg	

RONDO MINI



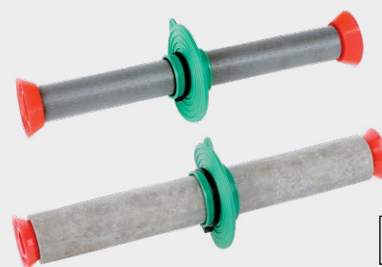

Sealing collars for waterproofing of plastic or fibre cement distance tubes

[Technical details page 180](#)



Art.Gr.
630

Art. no.	Type	Description	PU	Weight per bag	
090870	RONDO MINI 26 Suitable for 25-27 mm	for plastic distance tubes 22/26 mm Waterstop 2 cm Bearing width 2.7 cm	Bag of 50 pcs. including plastic fastening straps	1.50 kg	
090873	RONDO MINI 40 Suitable for 38-42 mm	for fibre cement distance tubes 22/40 mm Waterstop 2 cm Bearing width 2.7 cm	Bag of 50 pcs. including plastic fastening straps	2.00 kg	



ActiveRing



The swelling external high-pressure seal for plastic and fibre cement distance tubes [Technical details page 181](#)



Art.Gr.
620

Art. no.	Description	PU	Secondary packaging	Weight per bag	
047200	ActiveRing mini for outer pipe diameters 25-32 mm e.g. plastic distance tubes 22/26 26/31 26/32	Bag of 250 pcs.	1 pallet = 144 bags	1.75 kg	 ActiveRing mini
047250	ActiveRing maxi for outer pipe diameters 38-42 mm e.g. fibre cement distance tubes	Bag of 250 pcs.	1 pallet = 70 bags	2.50 kg	 ActiveRing maxi

CORRUGATED BEARING, IMPACT SOUND INSULATION + CONSTRUCTION BEARING

Corrugated bearing [Technical details page 182](#)

Art.Gr.
641

Art. no.	Description	PU	Secondary packaging	Weight per roll	
060010	Corrugated bearing 10 mm Size: 10000 x 200 x 10 mm with 3 parting seams	1 roll = 2 m ²	1 pallet = 30 rolls	15.60 kg	

Impact sound insulation T1 rolls [Technical details page 183](#)

Art.Gr.
640

Art. no.	Description	PU	Secondary packaging	Weight per roll	
060240	Impact sound insulation roll T1 Size: 10000 x 100 x 5 mm	1 roll	1 pallet = 110 rolls	4.65 kg	
060230	Impact sound insulation roll T1 Size: 10000 x 100 x 10 mm	1 roll	1 pallet = 60 rolls	8.25 kg	

Impact sound insulation T1 strips

Art.Gr.
640

Art. no.	Description	PU	Secondary packaging	Weight per strip	
060210	Impact sound insulation strip T1 Size: 1000 x 100 x 10 mm	1 strip	1 pallet = 750 strips	0.89 kg	

Impact sound insulation T1 boards

Art.Gr.
640

Art. no.	Description	PU	Secondary packaging	Weight per board	
060110	Impact sound insulation board T1 Size: 1000 x 1000 x 10 mm	1 board	1 pallet = 80 boards	9.00 kg	
060113	Impact sound insulation board T1 Size: 1000 x 1000 x 20 mm	1 board	1 pallet = 40 boards	17.50 kg	

Construction bearing R1 roll [Technical details page 183](#)

Art.Gr.
642

Art. no.	Description	PU	Secondary packaging	Weight per roll	
060350	Construction bearing roll R1 , Size: 10000 x 50 x 10 mm	1 roll	1 pallet = 80 rolls	6.95 kg	

Construction bearing R1 strips

Art.Gr.
642

Art. no.	Description	PU	Secondary packaging	Weight per strip	
060340	Construction bearing strip R1 , Size: 1000 x 100 x 5 mm	1 strip	1 pallet = 1500 strips	0.71 kg	
060330	Construction bearing strip R1 , Size: 1000 x 100 x 10 mm	1 strip	1 pallet = 750 strips	1.55 kg	

Construction bearing R1 boards

Art.Gr.
642

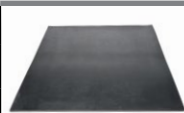
Art. no.	Description	PU	Weight/board	
060310	Construction bearing board R1 , Size: 1200 x 1000 x 5 mm	1 board	7.50 kg	
060300	Construction bearing board R1 , Size: 1200 x 1000 x 10 mm	1 board	15.00 kg	

Tailor-made sizes available at short notice

KLEBO tapes

High-quality adhesive tapes for daily use on construction sites

Art.Gr.
660

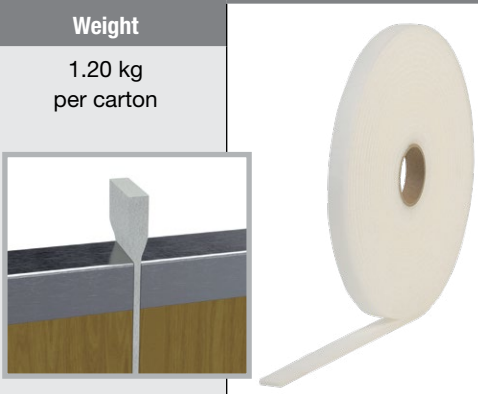
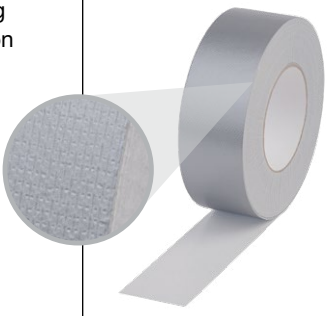
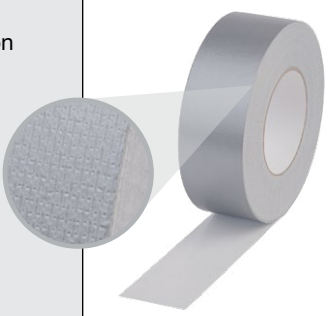
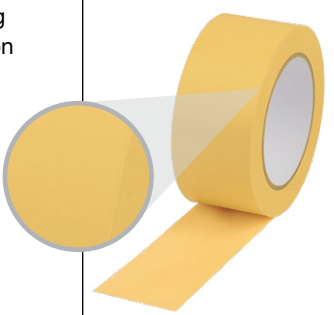
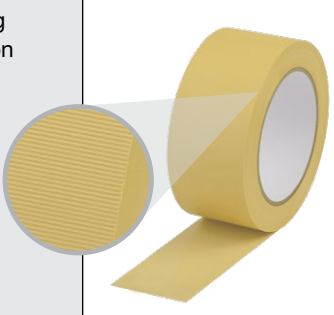
Art. no.	Description	PU	Weight	
044020	<p>KLEBO foam tape 19x6 mm One-sided self-adhesive foam tape Colour: white Roll length: 10 m Tape width: 19 mm Thickness: 6 mm</p> <p>Application: For sealing formwork butt joints against leakage of cement paste; sealing against dust, draughts and moisture;</p> <p>Technical data and properties: Open-cell PU foam coated with a strong pressure-sensitive adhesive; High initial and permanent adhesive strength; Very good ageing resistance;</p> <p>Application temperature: +5 °C to +40 °C Temperature resistance: -5°C to +60°C</p>	<p>1 carton of 16 rolls</p> <p>1 pallet = 24 cartons</p>	1.20 kg per carton	
044030	<p>KLEBO Duct Tape Premium, 48 mm Colour: silver Roll length: 50 m Tape width: 48 mm</p> <p>Application: Fabric adhesive tape with maximum adhesive strength for demanding bonds on rough and smooth substrates.</p> <p>Technical data and properties: Hand tearable; Moisture resistant; Thickness 0.22 mm; Application temperature: +5 °C to +40 °C Temperature resistance: -10°C to +70°C</p>	<p>1 carton of 24 rolls</p> <p>1 pallet = 24 cartons</p>	12.10 kg per carton	
044040	<p>KLEBO Duct Tape Standard, 48 mm Colour: silver Roll length: 50 m Tape width: 48 mm</p> <p>Application: Fabric adhesive tape with high adhesive strength for standard bondings on rough and smooth substrates.</p> <p>Technical data and properties: Hand tearable; Moisture resistant; Thickness 0.17 mm; Application temperature: +5 °C to +40 °C Temperature resistance: -10°C to +70°C</p>	<p>1 carton of 24 rolls</p> <p>1 pallet = 30 cartons</p>	8.90 kg per carton	
044050	<p>KLEBO PVC adhesive tape, smooth, 50 mm Tear-resistant soft PVC adhesive tape Colour: yellow Roll length: 33 m Tape width: 50 mm</p> <p>Application: Formwork tape to prevent cement paste from flowing out; Painter's and plasterer's tape for short-term use; universal applications;</p> <p>Technical data and properties: Moisture resistant – water repellent; Thickness 0.15 mm; Application temperature: +5 °C to +40 °C Temperature resistance: -5°C to +60°C</p>	<p>1 carton of 36 rolls</p> <p>1 pallet = 27 cartons</p>	13.50 kg per carton	
044060	<p>KLEBO PVC adhesive tape, cross-grooved, 50 mm Tear-resistant soft PVC adhesive tape Colour: yellow Roll length: 33 m Tape width: 50 mm</p> <p>Application: Formwork tape to prevent cement paste from flowing out; Painter's and plasterer's tape for short-term use; universal applications;</p> <p>Technical data and properties: The cross-grooved surface enables easy tearing by hand; Moisture-resistant – water-repellent; thickness 0.16 mm; Application temperature: +5 °C to +40 °C Temperature resistance: -5°C to +60°C</p>	<p>1 carton of 36 rolls</p> <p>1 pallet = 27 cartons</p>	12.15 kg per carton	

MURO-Top damp proof course

The barrier against rising damp

Art.Gr.
600



MURO-Top damp proof courses

- Made of the highly-resistant material polyolefin
- Protect foundation walls and masonry reliably and permanently against rising damp
- Profiled on both sides
- Resistant to many media
- Installed in a single layer with only 20 cm overlap at joint
- Foils with a thickness of less than 1.2 mm are not suitable for applications requiring a General Building Supervisory Test Certificate

Art. no.	Roll width	Roll length	Roll area	PU	Secondary packaging	Weight per roll
041115	11.5 cm	50 m	5.75 m ²	1 roll	Pallet of 500 rolls	approx. 1.50 kg
041150	15.0 cm	50 m	7.50 m ²	1 roll	Pallet of 400 rolls	approx. 2.25 kg
041175	17.5 cm	50 m	8.75 m ²	1 roll	Pallet of 350 rolls	approx. 2.35 kg
041200	20.0 cm	50 m	10.00 m ²	1 roll	Pallet of 300 rolls	approx. 2.55 kg
041240	24.0 cm	50 m	12.00 m ²	1 roll	Pallet of 240 rolls	approx. 3.05 kg
041250	25.0 cm	50 m	12.50 m ²	1 roll	Pallet of 240 rolls	approx. 3.70 kg
041300	30.0 cm	50 m	15.00 m ²	1 roll	Pallet of 200 rolls	approx. 4.15 kg
041365	36.5 cm	50 m	18.25 m ²	1 roll	Pallet of 160 rolls	approx. 4.85 kg
041425	42.5 cm	50 m	21.25 m ²	1 roll	Pallet of 150 rolls	approx. 5.85 kg
041500	50.0 cm	50 m	25.00 m ²	1 roll	Pallet of 120 rolls	approx. 6.30 kg
041750	75.0 cm	50 m	37.50 m ²	1 roll	Pallet of 100 rolls	approx. 10.30 kg
041000	100.0 cm	50 m	50.00 m ²	1 roll	Pallet of 80 rolls	approx. 13.85 kg

Technical data

- Material: Polyolefin, roughly textured on both sides
- Thickness: 0.3 mm, 0.35 mm including profile
- Weight: Approx. 280 g/m²
- Temperature range: -30°C to +60°C

- Resistance:
- Water-impermeable
 - Compatible with bitumen
 - Petrol-resistant
 - Ground water-resistant
 - Alkali-resistant
 - Rot-proof
 - Diesel-resistant
 - Ground water-neutral

STOPPER SCREW



Screwed sealing of formwork tie points – maximum safety with superb appearance

- Pressure water-tight, soundproof and radon-tight
- Fire resistance class EI 240
- For fibre cement and plastic distance tubes
- For conical anchor holes
- Little storage space required
- All-weather installation



Installation

Insert – Tighten – Tight

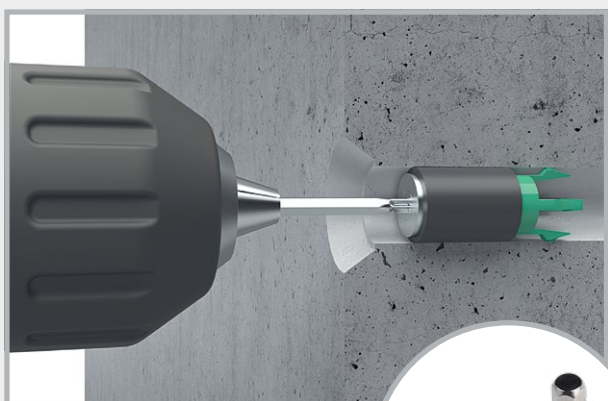

Torque set for ensuring the correct mounting torque

Appearance

Type "in"

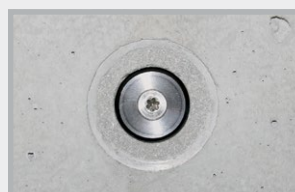

Type "covered"

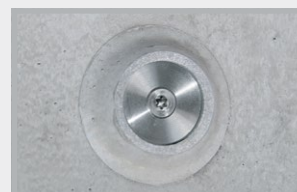
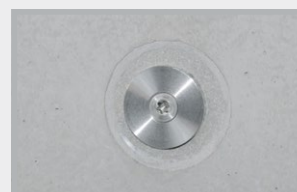

Seal for distance tubes with lip seal (above) or with cone (below).

Water pressure test



Type of formwork tie point	STOPPER SCREW Type "in" Water column	STOPPER SCREW Type "covered" Water column
Distance tube Ø 22 mm Plastic/fibre cement	70 m	70 m
Distance tube Ø 26 mm Plastic	40 m	40 m
Distance tube Ø 27 mm Fibre cement	40 m	40 m
Distance tube Ø 32 mm Plastic	40 m	40 m
Conical anchor holes	50 m	50 m

STOPPER



Inner seals for plastic and fibre cement distance tubes



Installation of STOPPER in



The STOPPER in is pushed into the distance tube.



The STOPPER in is driven in with a 1500-2000 g hard rubber mallet.



Flush seal for distance tubes with lip seal.



Flush seal for distance tubes with cone.



The STOPPER in can be inserted to any depth.



After inserting the STOPPER in, a cone can be glued in.

Installation of STOPPER mini



Position and drive in the STOPPER mini



Sealing of distance tube with lip



Sealing of distance tube with cone

Installation of STOPPER maxi



Push the STOPPER maxi into the distance tube



Drive in with rubber mallet



Pressure-tight and flush seal

STOPPER tests

Water



Tube type	STOPPER maxi 22 Water column	STOPPER mini 22 Water column	STOPPER in 22 Water column	STOPPER in 26 Water column
Plastic distance tube inner diameter approx. 21.5-23 mm	50 m	50 m	30 m	-
Fibre cement distance tube inner diameter approx. 22 mm, round	40 m	40 m	20 m	-
Steel distance tube inner diameter approx. 22.45 mm, round	40 m	40 m	20 m	-
Steel distance tube inner diameter approx. 23 mm, round	30 m	30 m	20 m	-
Plastic distance tube inner diameter 26 mm	-	-	-	50 m

Fire



- Fire resistance class EI 120 to DIN EN 13501-2 (STOPPER mini/STOPPER maxi)
 Room closure test with fibre cement distance tubes
 For the duration of the test (120 minutes), no cracks or gaps developed on the room side.
 During this time, no flames were visible on the side facing away from the fire.
- Fire resistance class EI 240 (STOPPER in 22 / STOPPER in 26)
- Construction material class
 DIN EN 13501-1 E = normally flammable
 DIN 4102-1 B2 = normally flammable

Resistance



As well as undergoing a comprehensive slurry/liquid manure/silage effluent test, the plastic is also resistant to several media:

- Slurry
 - Liquid manure
 - Silage effluent
 - Fermentation mash
 - Radon + methane gas
 - UV radiation
 - Diluted acids + alkalis
 - Ozone
 - Bitumen
 - Oils
- Depending on the concentration
 (Please consult our team)

Sound insulation



Standard sound level differential - test

MFPA test according to DIN EN ISO 10140-2

A distance tube installed in concrete and sealed at both ends with the STOPPER achieves exactly the same standard sound level as monolithic concrete with the same component thickness.

STOPPER distance tube

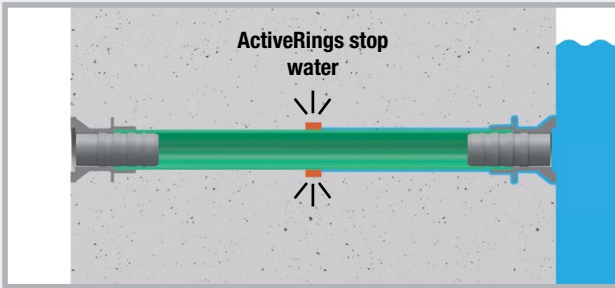

After stripping the formwork, the ActiveRing sits centrally in the concrete part. The ActiveRing seals the transition between the STOPPER distance tube and the concrete securely and permanently.

Sealing options for the STOPPER distance tube

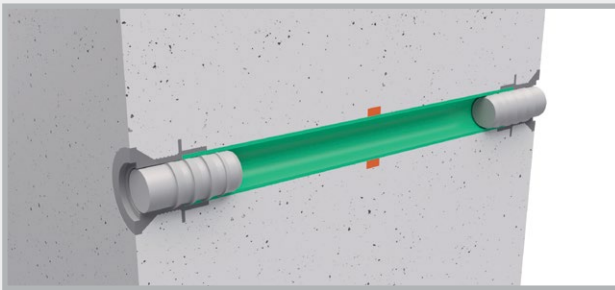

Pressurised water test up to 30 m water column

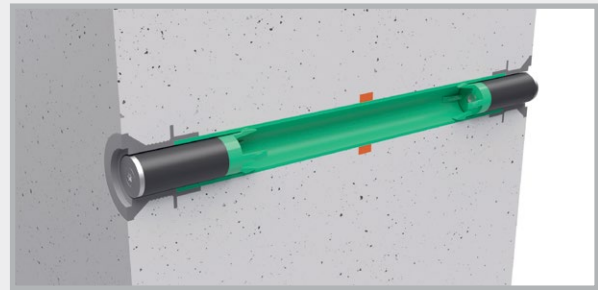

Pressurised water test up to 70 m water column

STOPPER sealing cone

Fibre cement cone for bonding for a visually appealing distance tube closure

Art.Gr.
610

- For distance tubes \varnothing 22 mm
- Cone height 8 mm
- Building material class A1 – non-combustible
- Colour: cement grey

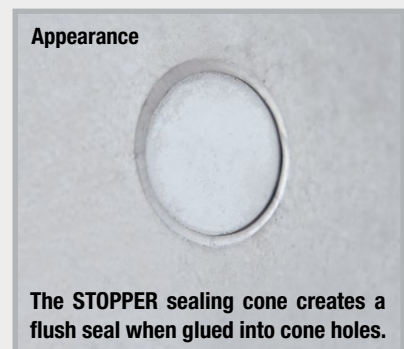
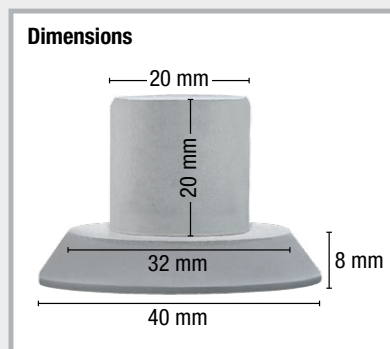

Bonding options

Concrete adhesive for gluing into the cone holes can be found in product group 3 on page 94 in our full catalogue. The single-component PROTECT Easy 1K and the two-component PROTECT BK 2K have been specifically developed for this application.



PROTECT Easy 1K (Art. no. 040030)



PROTECT BK 2K (Art. no. 040100)

RONDO MINI

Sealing collars for waterproofing of plastic or fibre cement distance tubes



Art.Gr. 630

RONDO MINI sealing collars can be mounted onto plastic or fibre cement distance tubes quickly and easily at the construction site.

- Pressure test performed by MFPA Leipzig
- Easy and safe installation
- Good chemical resistance
- Very cost-effective
- Push on, fasten and tight

Resistance

- Diluted acids + alkalis
- Liquid manure + slurry
- Fermentation mash
- Oils and bitumen
- Radon + methane gas

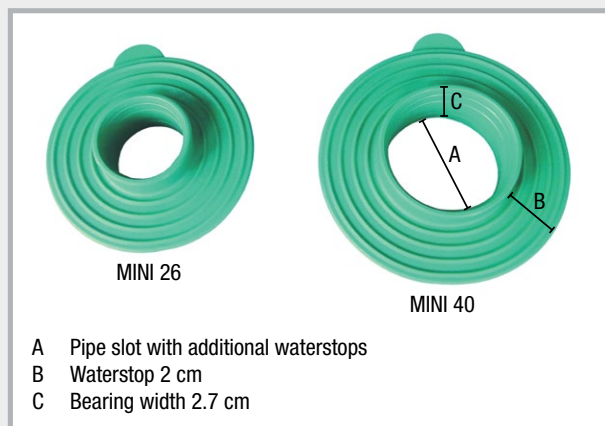

Product description

Material: TPE polymer compound
Installation: Temperature range -35°C to +70°C

Quick and easy installation

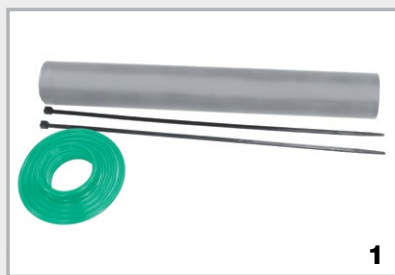

Fibre cement distance tube, RONDO MINI, 2 fastening straps

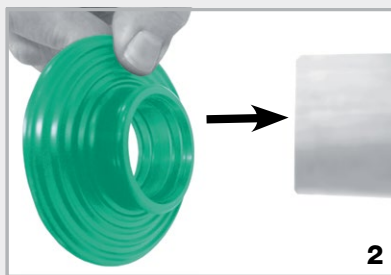

Slide the RONDO MINI onto the distance tube

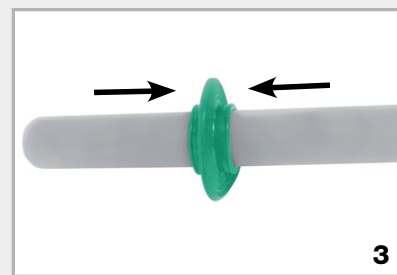

Position RONDO MINI in the centre before fastening



Tighten both fastening straps by hand



The fastening straps can also be tightened using pliers



RONDO MINI installation complete

ActiveRing



The swelling external high-pressure seal for plastic and fibre cement distance tubes

Art.Gr.
620

The ActiveRings mini and maxi are made of a highly swellable TPE mixture. When the rings come into contact with water, they activate, swell up and reliably stop the flow of water.

- Pressure test performed by MFPA Leipzig
- Easy and safe installation
- Good chemical resistance
- Very cost-effective
- Push on and seal



High-pressure seal up to 80 m water column

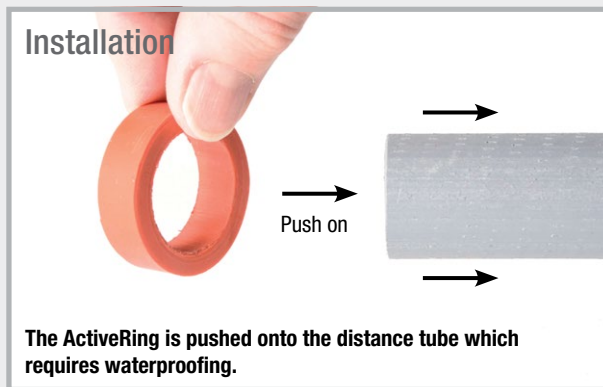

Installation

Push on

The ActiveRing is pushed onto the distance tube which requires waterproofing.

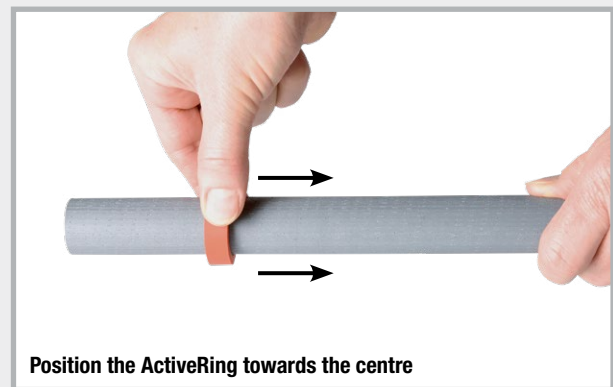

Position the ActiveRing towards the centre

ActiveRings provide security

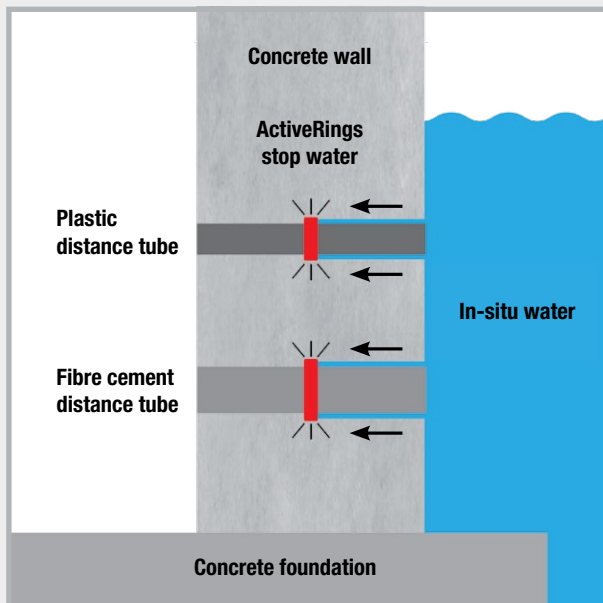

This is how ActiveRings work: When the rings come into contact with water, they activate, swell up and the resultant swell pressure stops the flow of water and provides a reliable seal. The seal remains permanently active when in contact with water.

Resistance

- Diluted acids and alkalis
- Salt water
- Methane gas + radon
- Liquid manure + slurry
- Fermentation mash + biogas
- Concrete alkalinity
- Liquid aggressive to concrete



At the construction site

Corrugated bearing



Product description

Material: The corrugated bearing is a profiled bearing based on EPDM.

Application: For bearing of stairs and slabs
Bearing of prefabricated elements

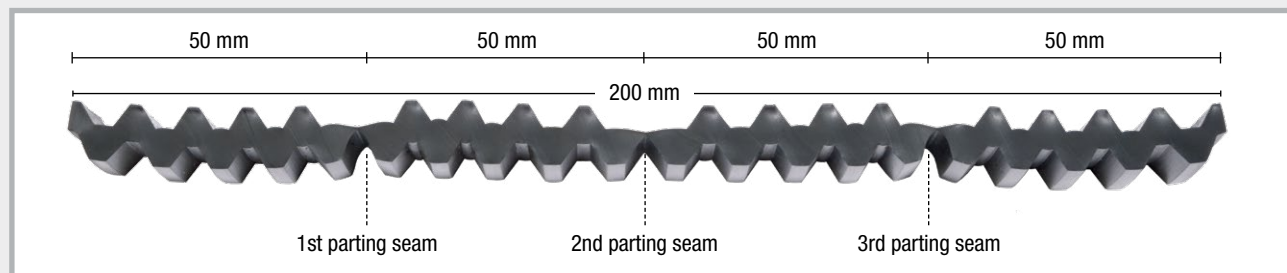

Description: Rolls
Testing: Load test up to 5 N/mm²
Impact sound reduction up to 20 dB

Temperature resistance: -40°C to +90°C

Elongation at break: >300%

Environmental aspects: UV-resistant, halogen-free

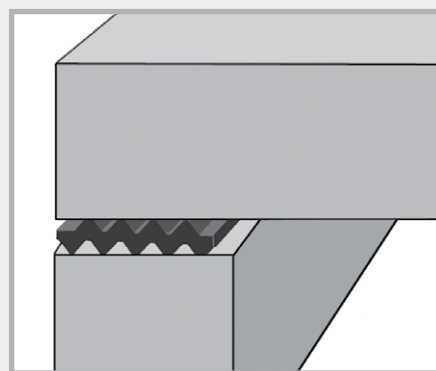

Corrugated bearing between two constructional elements

Application



Corrugated bearing



The corrugated bearing can be cut with a cutter. Cut into the parting seam, the corrugated bearing can then be processed.



Over a width of 20 cm the corrugated bearing has 3 parting seams. This enables bearing widths of 5, 10, 15 and 20 cm.

Impact sound insulation T1



Product description

Material: The impact sound insulation bearing T1 is made of fine mixed elastomer fibres bonded with PUR.

Application: As bearing for stairs and slabs

Description: Rolls, strips and boards

Testing: Load test for thickness 10 mm up to 5 N/mm²

Impact sound reduction up to 19 dB

Temperature resistance: -40°C to +90°C

Elongation at break: >70%

Reaction to fire: Class E

Environmental aspects: UV-resistant

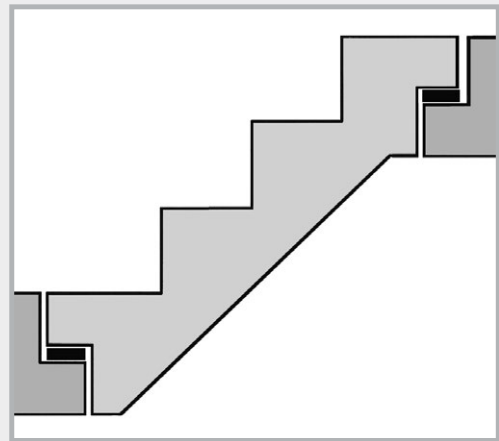

Impact sound insulation T1, e.g. for bearing of staircases

Construction bearing R1

Product description

Material: NR-SBR copolymer

Application: Separation of 2 construction elements
Bearing of staircases
Levelling out of unevenness

Description: Strips, boards + rolls

Temperature resistance: -25°C to +70°C

Elongation at break: >200%

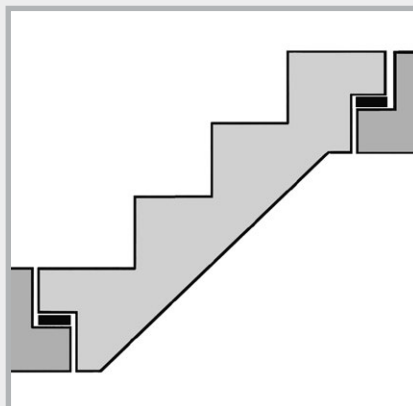
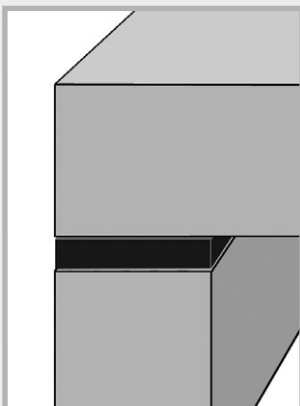

Ceiling installation

Notes

A series of horizontal dotted lines for writing notes, spanning the width of the page below the title.

Notes

Lined writing area with horizontal dotted lines.

SWELLING TAPES

JOINT SHEET METALS

**INJECTION HOSES
CONSTRUCTION CHEMISTRY**

**PRESSURE WATER-TIGHT
SERVICE DUCTS**

LIGHTNING PROTECTION

FORMWORK ACCESSORIES

MASTERTEC GmbH & Co. KG
Special articles for reinforced concrete construction

Gewerbegebiet Unterhaid
Im Maintal 13
96173 Oberhaid, Germany
Tel. +49 (0) 9503 / 5047-0

info@mastertec.eu
www.mastertec.eu

