



# MASTERTEC

SPECIAL ARTICLES FOR REINFORCED CONCRETE CONSTRUCTION

# LIGHTNING PROTECTION

## PRICE LIST

**PRODUCT GROUP 5**

## 2024/2025



# MASTERTEC

SPECIAL ARTICLES FOR REINFORCED CONCRETE CONSTRUCTION

## MASTERTEC – a family business, now being run by its second generation

MASTERTEC is based in Oberhaid, 10 km from the famous UNESCO world heritage city of Bamberg. The family business was founded in 1998 by Rainer and Gabriele Kropfelder. Over the years, the number of employees has grown to over 50. Sons Felix and Jakob are taking on more and more responsibility for the further development of the company.

Working together with employees, customers and suppliers as equals, open dialogue and mutual respect have all contributed greatly to the positive development of the company.

Our products are used in the fields of waterproofing for joints and penetrations in reinforced concrete construction, earthing and lightning protection, and formwork accessories.



Over the last 25 years, we have developed many products which provide additional safety for all construction sites in many countries. Comprehensive testing at different renowned testing institutes guarantees the functionality of our technologies.

Jakob Kropfelder (B.Sc.) and Felix Kropfelder (B.Eng.),  
Managing Directors at MASTERTEC

Over the years, we have found distributors, sales partners and friends in 35 different countries, all of whom have supported us for a long time with their professional knowledge and have contributed greatly to the development of MASTERTEC.

The MASTERTEC team would like to say thank you, and we look forward to continuing to work together with you.

### You can contact us

Monday – Thursday

7:15 am – 12:00 pm

12:45 – 4:30 pm

Friday

7:15 am – 12:00 pm

12:45 – 3:00 pm

# LIGHTNING PROTECTION



**Earth conductors**  
pages 4 – 5

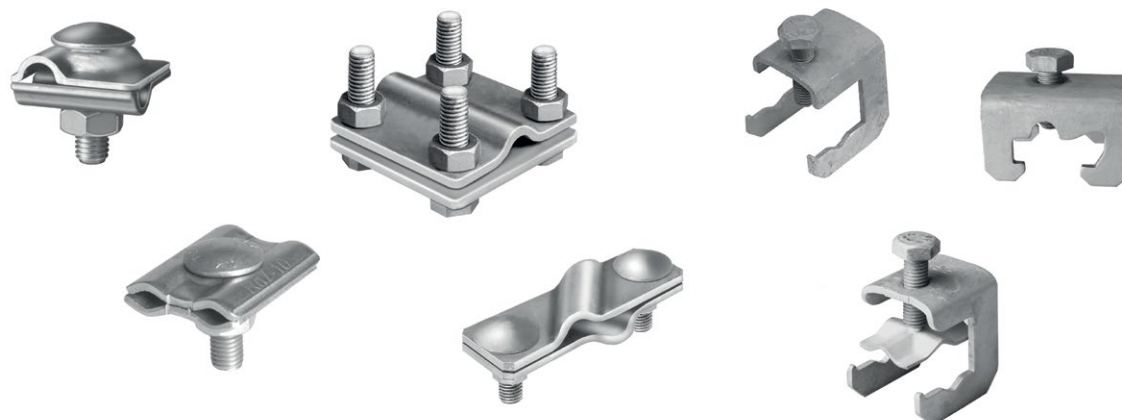

**Connectors**  
pages 6 – 11



**Fixed earthing terminals, wall bushings + accessories**  
pages 12 – 25

pages 26  
pages 27 – 28

Basic principles of the installation of lightning protection conductors and connectors  
Shipping costs

# Earth conductors

Dimensions and materials according to DIN EN 62561-2

## Earthing straps

### Galvanised steel

Art.Gr.  
500

Art. no.	Size	Material	PU	Secondary packaging	Price
100014	30 x 3.5 mm	Galvanised steel Z 500	1 roll of 25 kg = approx. 30 m	1 pallet = 40 rolls	<b>Current price available on request</b>
100016	30 x 3.5 mm	Galvanised steel Z 500	1 roll of 50 kg = approx. 60 m	1 pallet = 20 rolls	<b>Current price available on request</b>
100022	40 x 4.0 mm	Galvanised steel Z 500	1 roll of 50 kg = approx. 39 m	1 pallet = 20 rolls	<b>Current price available on request</b>
100024	40 x 5.0 mm	Galvanised steel Z 500	1 roll of 50 kg = approx. 32 m	1 pallet = 20 rolls	<b>Current price available on request</b>

### Stainless steel

Art. no.	Size	Material	PU	Secondary packaging	Price
100028	30 x 3.5 mm <span style="border: 1px solid black; padding: 2px;">Art.Gr. 502</span>	V2A stainless steel according to DIN EN 62561-2	1 roll of 25 kg = approx. 30 m	1 pallet = 40 rolls	<b>Current price available on request</b>
100031	30 x 3.5 mm <span style="border: 1px solid black; padding: 2px;">Art.Gr. 501</span>	V4A stainless steel according to DIN EN 62561-2	1 roll of 25 kg = approx. 30 m	1 pallet = 40 rolls	<b>Current price available on request</b>
100032	30 x 3.5 mm <span style="border: 1px solid black; padding: 2px;">Art.Gr. 501</span>	V4A stainless steel according to DIN EN 62561-2	1 roll of 50 kg = approx. 60 m	1 pallet = 20 rolls	<b>Current price available on request</b>
100035	40 x 4.0 mm <span style="border: 1px solid black; padding: 2px;">Art.Gr. 501</span>	V4A stainless steel according to DIN EN 62561-2	1 roll of 50 kg = approx. 39 m	1 pallet = 20 rolls	<b>Current price available on request</b>

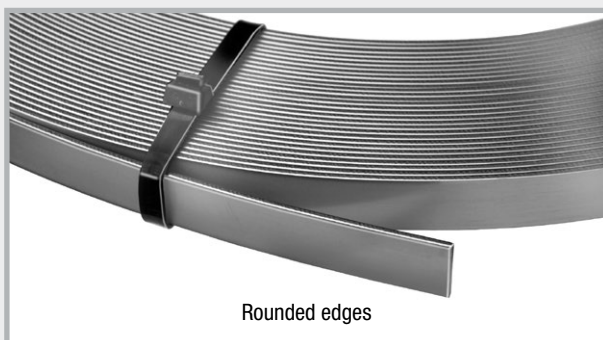
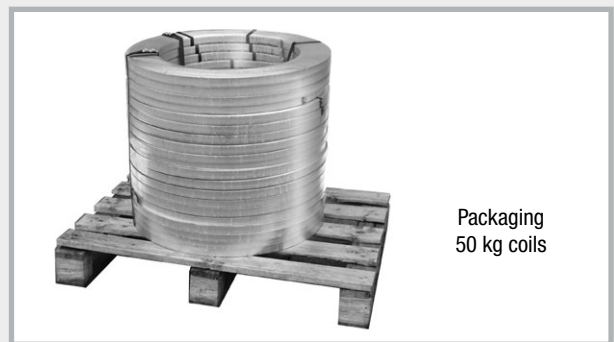

# Round wires



Single coil, galvanised

Single coil  
Stainless steel standardSingle coil  
Stainless steel SUPER-SOFTSingle coil  
Aluminium round wire

## Galvanised steel

Art.Gr.  
**505**

Art. no.	Size	Material	PU	Secondary packaging	Price
<b>100041</b>	Ø 10 mm	Galvanised steel Z 350	1 roll of 25 kg = approx. 40.5 m	1 pallet = 40 rolls	<b>Current price available on request</b>
<b>100042</b>	Ø 10 mm	Galvanised steel Z 350	1 roll of 50 kg = approx. 81 m	1 pallet = 20 rolls	<b>Current price available on request</b>

## Stainless steel standard

Art. no.	Size	Material	PU	Secondary packaging	Price
<b>100051</b>	Ø 10 mm <small>Art.Gr. 507</small>	V2A stainless steel according to DIN EN 62561-2	1 roll of 25 kg = approx. 40.5 m	1 pallet = 20 rolls	<b>Current price available on request</b>
<b>100055</b>	Ø 10 mm <small>Art.Gr. 506</small>	V4A stainless steel according to DIN EN 62561-2	1 roll of 25 kg = approx. 40.5 m	1 pallet = 20 rolls	<b>Current price available on request</b>
<b>100056</b>	Ø 10 mm <small>Art.Gr. 506</small>	V4A stainless steel according to DIN EN 62561-2	1 roll of 50 kg = approx. 81 m	1 pallet = 10 rolls	<b>Current price available on request</b>
<b>100062</b>	Ø 10 mm <small>Art.Gr. 506</small>	V4A stainless steel according to DIN EN 62561-2	1 roll of 31 kg = approx. 50 m	1 pallet = 16 rolls	<b>Current price available on request</b>

## Stainless steel SUPER-SOFT

A special manufacturing procedure ensures uniformly soft quality of the wire. SUPER-SOFT can be unrolled very easily and lies flat without undulation.

Art.Gr.  
**508**

Art. no.	Size	Material	PU	Secondary packaging	Price
<b>100061</b>	Ø 10 mm	SUPER-SOFT V4A according to DIN EN 62561-2, inner diameter 900 mm	1 roll of 25 kg = approx. 40.5 m	1 pallet = 40 rolls	<b>Current price available on request</b>

## Aluminium

Art.Gr.  
**509**

Art. no.	Size	Material	PU	Secondary packaging	Price
<b>100080</b>	Ø 8 mm	ALU AlMgSi soft-twistable	1 roll of 20 kg = approx. 148 m	1 pallet = 25 rolls	<b>Current price available on request</b>

## Multi-purpose connecting clamps

with mushroom head bolt and protection against twisting

Art.Gr.  
511



Art. no.	Description	PU	Secondary packaging	Weight per carton	Price per pc.
100147	<b>Galvanised steel</b> , 2-part, round/round, Clamping range: Round conductor Ø 8 + 10 mm, with M10 mushroom head bolt and protection against twisting	1 carton of 50 pcs.	1 pallet = 5600 pcs.	5.05 kg	€1.37
100149	<b>V2A stainless steel</b> , 2-part, round/round Clamping range: Round conductor Ø 8 + 10 mm, with M10 mushroom head bolt and protection against twisting	1 carton of 50 pcs.	1 pallet = 5600 pcs.	4.45 kg	€3.30
100150	<b>V4A stainless steel</b> , 2-part, round/round Clamping range: Round conductor Ø 8 + 10 mm, with M10 mushroom head bolt and protection against twisting	1 carton of 50 pcs.	1 pallet = 5600 pcs.	4.50 kg	€4.30

## Multi-purpose connecting clamps

with thread in lower part

Art.Gr.  
511

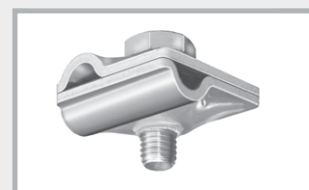

Art. no.	Description	PU	Secondary packaging	Weight per carton	Price per pc.
100157	<b>Galvanised steel</b> , 2-part, round/round, Clamping range: Ø 8 + 10 mm, M10 screw, thread in lower part	1 carton of 50 pcs.	1 pallet = 5600 pcs.	4.45 kg	€1.55
100159	<b>V4A stainless steel</b> , 2-part, round/round Clamping range: Ø 8 + 10 mm, M10 screw, thread in lower part	1 carton of 50 pcs.	1 pallet = 5600 pcs.	3.75 kg	€4.00
100153	<b>Aluminium</b> , 2-part, round/round, Clamping range: Ø 8+ 10 mm, NIRO M10 screw, Thread in lower part	1 carton of 50 pcs.	1 pallet = 5600 pcs.	2.60 kg	€2.30

## MAXI multi-purpose connecting clamp

for connection of round conductors to the  
reinforcement and conductive connection of  
steel reinforcement with up to Ø 25 mm

Art.Gr.  
511

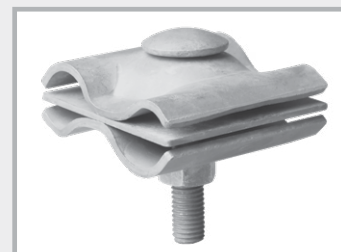

Art. no.	Description	PU	Secondary packaging	Weight per carton	Price per pc.
100148	<b>Galvanised steel</b> , round/round, Round conductor Ø 8-16 mm / Ø 15-25 mm, with mushroom head bolt and protection against twisting	1 carton of 25 pcs.	1 pallet = 1000 pcs.	11.10 kg	€7.15
100152	<b>V4A stainless steel</b> , round/round, Round conductor Ø 8-16 mm / Ø 15-25 mm, with mushroom head bolt and protection against twisting	1 carton of 25 pcs.	1 pallet = 1000 pcs.	10.05 kg	€19.50

# Stainless steel cross connectors round/round

Universal for flat/flat, flat/round and round/round

Clamping range: round conductor  $\varnothing$  8 + 10 mm, flat conductor up to 30 mm

Art.Gr.  
**512**

Art. no.	Description	PU	Secondary packaging	Weight per carton	Price per pc.
<b>100143</b>	<b>V4A stainless steel</b> , 2-part, round/round universal, heavy duty version, M8 screws	1 carton of 50 pcs.	1 pallet = 3200 pcs.	9.55 kg	<b>€7.55</b>
<b>100145</b>	<b>V4A stainless steel</b> , 2-part, round/round universal, light version, M6 screws	1 carton of 50 pcs.	1 pallet = 3200 pcs.	6.90 kg	<b>€6.30</b>

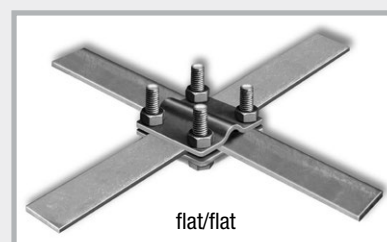
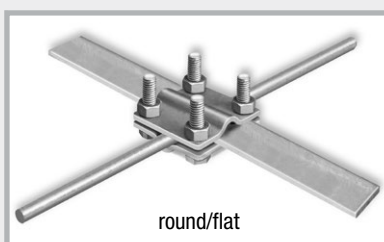
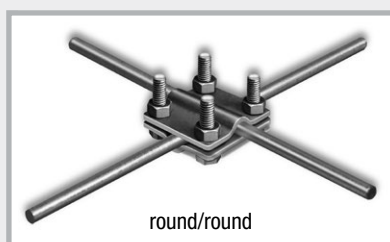

# Galvanised cross connectors flat/flat

Clamping range: flat conductor up to 30 mm

Art.Gr.  
**512**

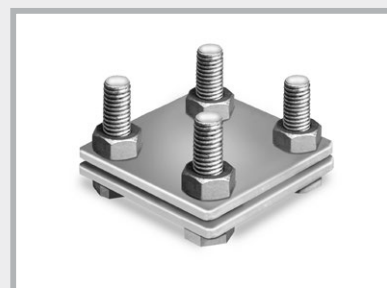

Art. no.	Description	PU	Secondary packaging	Weight per carton	Price per pc.
<b>100100</b>	<b>Galvanised steel</b> , 2-part, flat/flat, heavy duty version, M8 screws	1 carton of 50 pcs.	1 pallet = 3200 pcs.	10.75 kg	<b>€2.95</b>
<b>100106</b>	<b>Galvanised steel</b> , 2-part, flat/flat, light version, M6 screws	1 carton of 50 pcs.	1 pallet = 3200 pcs.	7.65 kg	<b>€1.95</b>

# Galvanised cross connectors flat/round

Clamping range:  
round conductor  $\varnothing$  8 + 10 mm,  
flat conductor up to 30 mm

Art.Gr.  
**512**

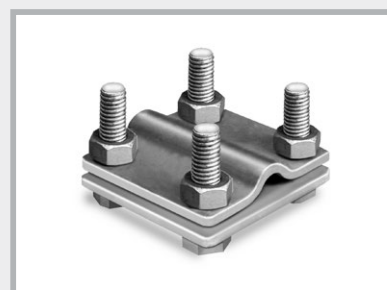

Art. no.	Description	PU	Secondary packaging	Weight per carton	Price per pc.
<b>100115</b>	<b>Galvanised steel</b> , 2-part, flat/round, heavy duty version, M8 screws	1 carton of 50 pcs.	1 pallet = 3200 pcs.	10.80 kg	<b>€2.95</b>
<b>100121</b>	<b>Galvanised steel</b> , 2-part, flat/round, light version, M6 screws	1 carton of 50 pcs.	1 pallet = 3200 pcs.	7.80 kg	<b>€2.10</b>

## Galvanised cross connector (for flat conductors up to 30 mm) round/round

Universal for flat/flat, flat/round and round/round

Clamping range: round conductor  $\varnothing$  8 + 10 mm, flat conductor 30 mm

Art.Gr.  
**512**

Art. no.	Description	PU	Secondary packaging	Weight per carton	Price per pc.
100127	Galvanised steel, 2-part, round/round, heavy duty version, M8 screws	1 carton of 50 pcs.	1 pallet = 3200 pcs.	10.95 kg	€3.00
100130	Galvanised steel, 3-part, round/round, heavy duty version, M8 screws With intermediate plate	1 carton of 50 pcs.	1 pallet = 3200 pcs.	14.65 kg	€4.00
100133	Galvanised steel, 2-part, round/round, light version, M6 screws	1 carton of 50 pcs.	1 pallet = 3200 pcs.	8.00 kg	€2.25

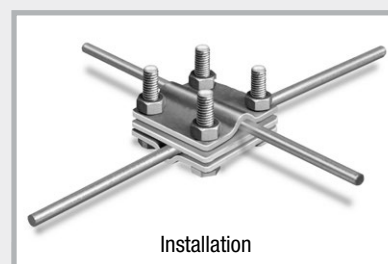
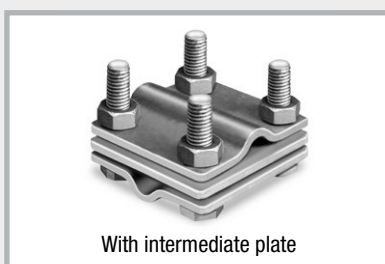
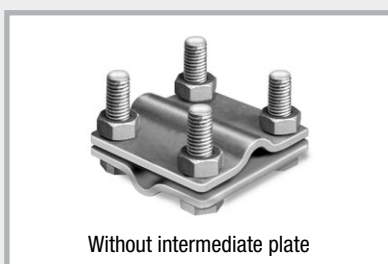

## Galvanised cross connector (for flat conductors up to 40 mm) round/round

Universal for flat/flat, flat/round and round/round

Clamping range: round conductor  $\varnothing$  8 + 10 mm, flat conductor 30 + 40 mm

Art.Gr.  
**512**

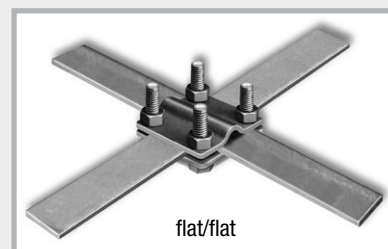
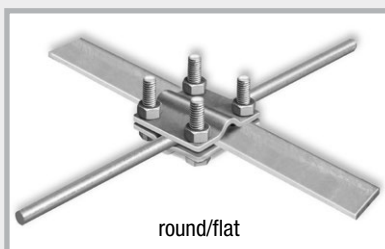
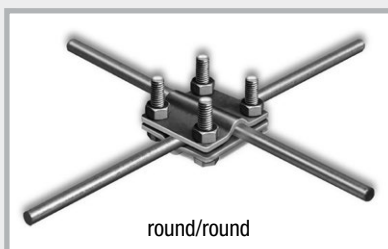

Art. no.	Description	PU	Secondary packaging	Weight per carton	Price per pc.
100129	Galvanised steel, 2-part, round/round, heavy duty version, M8 screws	1 carton of 50 pcs.	1 pallet = 3200 pcs.	17.60 kg	€4.95







Art.Gr.  
518

## Connecting clamps for flat conductors

Art. no.	Description	PU	Secondary packaging	Weight per carton	Price per pc.	
100250	<b>Galvanised steel</b> , M10 screw, flat conductors up to 30 mm and constructional steel Ø 6-22 mm	1 carton of 50 pcs.	1 pallet = 4000 pcs.	6.95 kg	€2.20	Art. no. 100250 Art. no. 100251 
100251	<b>Bright steel</b> , M10 screw, flat conductors up to 30 mm and constructional steel Ø 6-22 mm	1 carton of 50 pcs.	1 pallet = 4000 pcs.	6.45 kg	€2.10	
100253	<b>Galvanised steel</b> , M10 screw, flat conductors up to 40 mm and constructional steel Ø 6-22 mm	1 carton of 50 pcs.	1 pallet = 3200 pcs.	6.05 kg	€2.25	Art. no. 100252 Art. no. 100253 
100252	<b>V4A stainless steel</b> , M10 screw flat conductors up to 40 mm and constructional steel Ø 6-22 mm	1 carton of 50 pcs.	1 pallet = 3200 pcs.	5.25 kg	€5.80	

## Connecting clamps for flat and round conductors

Art.Gr.  
518

Art. no.	Description	PU	Secondary packaging	Weight per carton	Price per pc.	
100255	<b>Galvanised steel</b> , M10 screw, for flat conductors up to 30 mm, Round conductor Ø 8 + 10 mm, Constructional steel Ø 6-22 mm	1 carton of 50 pcs.	1 pallet = 3200 pcs.	9.30 kg	€2.95	Art. no. 100255 Art. no. 100257 
100257	<b>V4A stainless steel</b> , M10 screw, for flat conductors up to 30 mm, Round conductor Ø 8 + 10 mm, Constructional steel 6-22 mm	1 carton of 50 pcs.	1 pallet = 3200 pcs.	8.05 kg	€8.90	
100146	<b>Universal connecting clamp with pressure plate, Galvanised steel</b> , M10 screw, for flat conductors up to 30 mm, Round conductor Ø 8 + 10 mm, Constructional steel Ø 6-22 mm	1 carton of 50 pcs.	1 pallet = 3200 pcs.	7.55 kg	€3.25	Art. no. 100146 Art. no. 100254  Pressure plate
100254	<b>Universal connecting clamp with pressure plate, V4A stainless steel</b> , M10 screw, for flat conductors up to 30 mm, Round conductor Ø 8 + 10 mm, Constructional steel Ø 6-22 mm	1 carton of 50 pcs.	1 pallet = 3200 pcs.	6.40 kg	€7.90	

## Connecting clamps for round conductors

Art.Gr.  
518

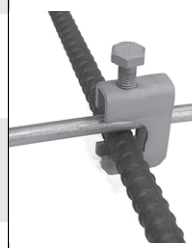
Art. no.	Description	PU	Secondary packaging	Weight per carton	Price per pc.	
<b>NEW!</b> 100258	<b>Galvanised steel</b> , M10 screw, for round connector Ø 6-10 mm, Constructional steel Ø 6-10 mm	1 carton of 50 pcs.	1 pallet = 4000 pcs.	5.00 kg	€1.60	Art. no. 100258 Art. no. 100259 Art. no. 100260 Art. no. 100261 
100259	<b>Galvanised steel</b> , M10 screw, for round conductors Ø 8 + 10 mm, Constructional steel Ø 6-22 mm	1 carton of 50 pcs.	1 pallet = 3200 pcs.	5.85 kg	€2.30	
100261	<b>Bright steel</b> , M10 screw, for round conductors Ø 8 + 10 mm, Constructional steel Ø 6-22 mm	1 carton of 50 pcs.	1 pallet = 3200 pcs.	5.60 kg	€2.20	
100260	<b>V4A stainless steel</b> , M10 screw, for round conductors Ø 8 + 10 mm, Constructional steel Ø 6-22 mm	1 carton of 50 pcs.	1 pallet = 3200 pcs.	5.10 kg	€5.80	

## Double clamps

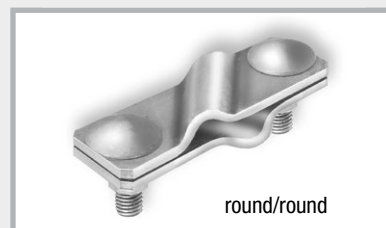
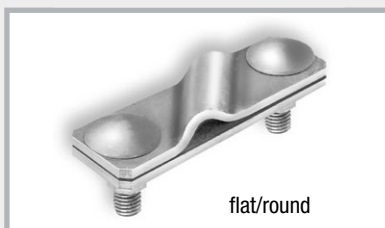
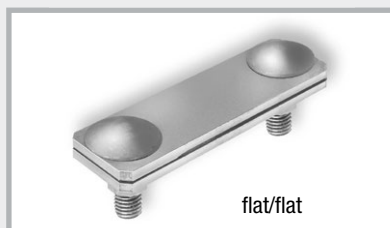

## Stainless steel double clamps

for earthing strap up to 40 mm width and round conductors  $\varnothing 8 + 10$  mm

Art.Gr.  
513

Art. no.	Description	PU	Secondary packaging	Weight per carton	Price per pc.
100273	V4A stainless steel, 2-part, flat/flat, heavy duty version, M10 screws	1 carton of 50 pcs.	1 pallet = 3200 pcs.	9.80 kg	€7.20
100279	V4A stainless steel, 2-part, flat/round, heavy duty version, M10 screws	1 carton of 50 pcs.	1 pallet = 3200 pcs.	9.35 kg	€7.20
100282	V2A stainless steel, 2-part, round/round heavy duty version, M10 screws	1 carton of 50 pcs.	1 pallet = 3200 pcs.	9.55 kg	€5.60
100285	V4A stainless steel, 2-part, round/round heavy duty version, M10 screws	1 carton of 50 pcs.	1 pallet = 3200 pcs.	9.35 kg	€7.40

## Galvanised double clamps

for earthing strap up to 40 mm width and round conductors  $\varnothing 8 + 10$  mm

Art.Gr.  
513

Art. no.	Description	PU	Secondary packaging	Weight per carton	Price per pc.
100220	Galvanised steel, 2-part, flat/flat, heavy duty version, M10 screws	1 carton of 50 pcs.	1 pallet = 3200 pcs.	12.15 kg	€2.65
100225	Galvanised steel, 2-part, flat/round, heavy duty version, M10 screws	1 carton of 50 pcs.	1 pallet = 3200 pcs.	11.60 kg	€2.65
100230	Galvanised steel, 2-part, round/round, heavy duty version, M10 screws	1 carton of 50 pcs.	1 pallet = 3200 pcs.	11.70 kg	€2.70

## Possible clamping connections

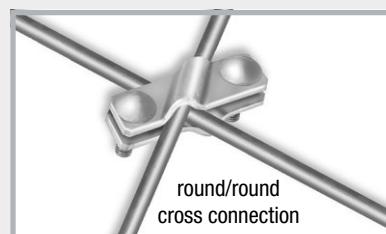
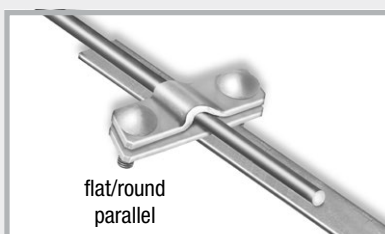
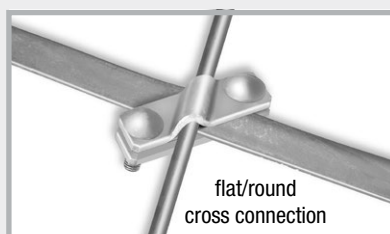
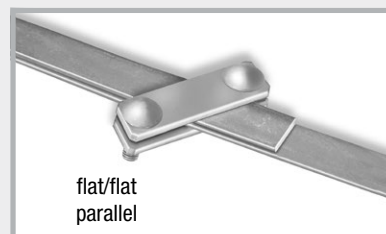
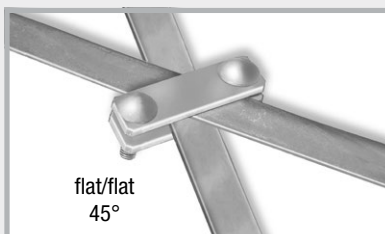
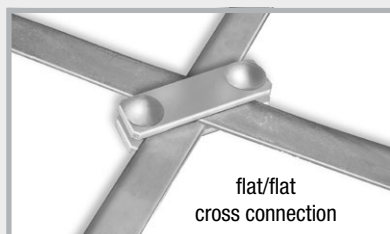

Art.Gr.  
514

## Single clamps

Art. no.	Description	PU	Secondary packaging	Weight per carton	Price per pc.
100163	<b>Galvanised steel</b> , 1 M10 screw, for flat conductors up to 30 mm and round conductors $\varnothing$ 8+ 10 mm, for T, cross and parallel connections	1 carton of 50 pcs.	1 pallet = 3200 pcs.	6.40 kg	<b>€2.20</b>
100162	<b>V4A stainless steel</b> , 1 M10 screw, for flat conductors up to 30 mm and round conductors $\varnothing$ 8+ 10 mm, for T, cross and parallel connections	1 carton of 50 pcs.	1 pallet = 3200 pcs.	5.25 kg	<b>€6.75</b>

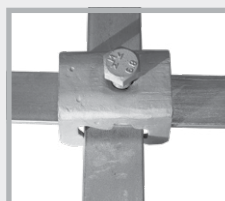
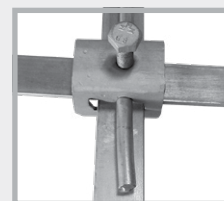

Single clamp

flat/flat  
parallel connectionflat/flat  
cross connectionflat/round  
parallel connectionflat/flat/round  
connection

## Parallel connectors

Art.Gr.  
514

Art. no.	Description	PU	Secondary packaging	Weight per carton	Price per pc.
100240	<b>Galvanised steel</b> , 1 M10 screw, 2-part, for round conductors $\varnothing$ 8 + 10 mm	1 carton of 50 pcs.	1 pallet = 5600 pcs.	7.35 kg	<b>€2.00</b>
100243	<b>V4A stainless steel</b> , 1 M10 screw, 2-part, for round conductors $\varnothing$ 8 + 10 mm	1 carton of 50 pcs.	1 pallet = 5600 pcs.	6.05 kg	<b>€5.95</b>



## Wedge connector

Art.Gr.  
514

Art. no.	Description	PU	Secondary packaging	Weight per carton	Price per pc.
100160	<b>Galvanised steel</b> , for round conductors $\varnothing$ 10 mm and flat conductors up to 40 mm, with lock-in position in the wedge	1 carton of 50 pcs.	1 pallet = 3200 pcs.	10.90 kg	<b>€2.40</b>

# Fixed earthing terminal M10/M12

to connect the equipotential bonding conductors to the ring electrode, reinforcement and lightning protection system

Art.Gr. 519



Art. no.	Description	PU	Weight per carton	Price per pc.	
100187	Fixed earthing terminal M10/M12, V4A stainless steel, without axis, with yellow protective cap, connection M10 + M12	1 carton of 10 pcs.	1.60 kg	€13.95	
100195	Fixed earthing terminal M10/M12 "Safe", without axis, with yellow protective cap and waterstop, connection M10 + M12	1 carton of 10 pcs.	2.00 kg	€22.60	
100202	Fixed earthing terminal M10/M12, V4A stainless steel, with mounted, galvanised axis, Length 200 mm, with yellow protective cap	1 carton of 10 pcs.	2.90 kg	€18.35	
100200	Fixed earthing terminal M10/M12, V4A stainless steel, with mounted A2 multi-purpose connecting clamp, with yellow protective cap	1 carton of 10 pcs.	2.40 kg	€17.45	

## Installation

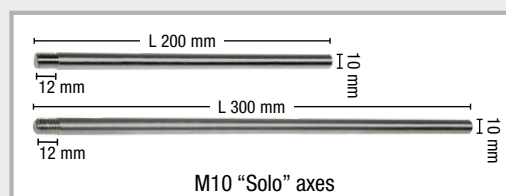
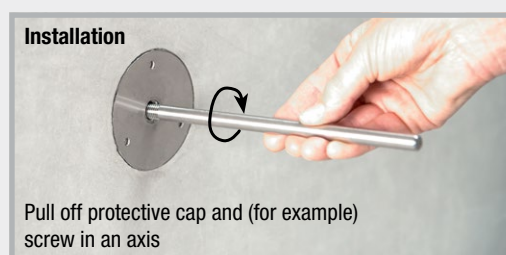
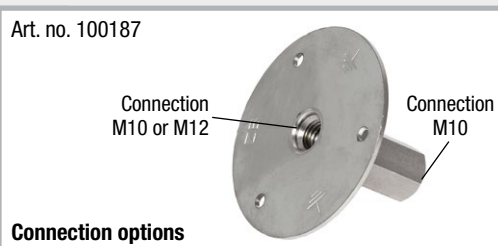

## M10 "Solo" axes for fixed earthing terminal

Art.Gr. 521

Art. no.	Description	PU	Weight/carton	Price/pc.
100183	galvanised, length 200 mm	Carton of 50 pcs.	6.00 kg	€4.40
100185	galvanised, length 300 mm	Carton of 50 pcs.	9.50 kg	€5.65
100184	V4A stainless steel, length 200 mm	Carton of 50 pcs.	6.00 kg	€8.00
100186	V4A stainless steel, length 300 mm	Carton of 50 pcs.	9.00 kg	€13.30

## M10 "Safe" axes for pressure water-tight fixed earthing terminal

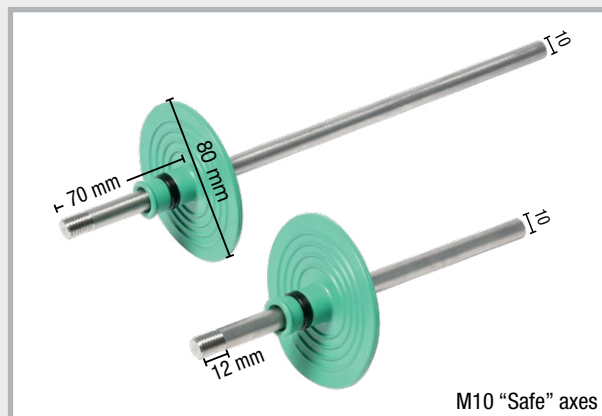

 Art.Gr.  
**521**

M10 "Safe" axes

Art. no.	Description	PU	Weight/pc.	Price/pc.
100177	galvanised, length 200 mm	1 pc.	0.15 kg	€10.40
100178	galvanised, length 300 mm	1 pc.	0.22 kg	€11.80
100179	V4A stainless steel, length 200 mm	1 pc.	0.15 kg	€15.90
100180	V4A stainless steel, length 300 mm	1 pc.	0.21 kg	€22.70



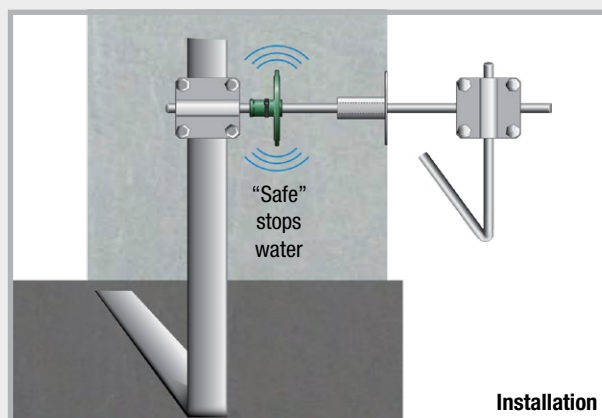

Fixed earthing terminal with "Safe" axis



Installation

## Cross clamps for fixed earthing terminals M10/12

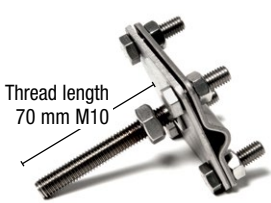
 Art.Gr.  
**522**

Art. no.	Description	PU	Weight per carton	Price per pc.	
100188	<b>Cross clamp for fixed earthing terminal M10/12, galvanised,</b> M10 thread, Thread length 70 mm, for round conductors Ø 8 + 10 mm and flat conductors up to 40 mm	Carton of 10 pcs.	3.80 kg	€11.90	Art. no. 100188 Art. no. 100189  Thread length 70 mm M10
100189	<b>Cross clamp for fixed earthing terminal M10/12, V4A stainless steel,</b> M10 thread, Thread length 70 mm, for round conductors Ø 8 + 10 mm and flat conductors up to 40 mm	Carton of 10 pcs.	3.20 kg	€24.00	<b>Installation</b> Fixed earthing terminal with screwed in cross clamp. Round and flat conductors can be connected. 

## M10 “Safe” wall bushings with pre-assembled fixed earthing terminals

The M10 wall bushings are pre-assembled and supplied in the exact wall thickness. Time-consuming adjustments are not necessary.

Fixed earthing terminal: V4A stainless steel,  
connection axe 10 mm: stainless steel

Art.Gr.  
**520**

Wall thickness	Art. no.	Weight/pc.	Price/pc.
200 mm	<b>100394</b>	0.42 kg	<b>€49.20</b>
240 mm	<b>100396</b>	0.45 kg	<b>€50.80</b>
250 mm	<b>100398</b>	0.45 kg	<b>€50.90</b>
300 mm	<b>100400</b>	0.48 kg	<b>€52.15</b>
350 mm	<b>100402</b>	0.52 kg	<b>€52.90</b>
365 mm	<b>100404</b>	0.53 kg	<b>€53.00</b>
400 mm	<b>100406</b>	0.55 kg	<b>€54.10</b>

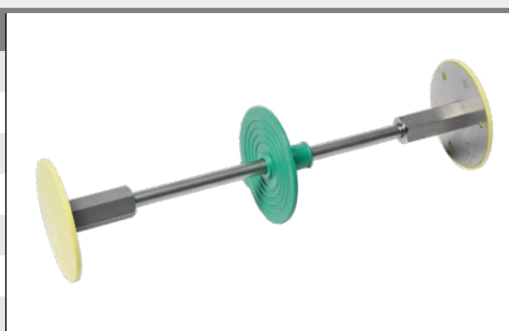

## M10 connection axis “Safe” for wall bushings

Stainless steel, diameter 10 mm, M10 thread at both ends,  
length of thread 12 mm

Art.Gr.  
**521**

Wall thickness	Art. no.	Weight/pc.	Price/pc.
200 mm	<b>100360</b>	0.10 kg	<b>€15.90</b>
240 mm	<b>100365</b>	0.13 kg	<b>€18.00</b>
250 mm	<b>100370</b>	0.13 kg	<b>€18.20</b>
300 mm	<b>100375</b>	0.16 kg	<b>€19.90</b>
350 mm	<b>100380</b>	0.20 kg	<b>€20.40</b>
365 mm	<b>100385</b>	0.21 kg	<b>€20.90</b>
400 mm	<b>100390</b>	0.23 kg	<b>€21.80</b>



## M10 “Solo” wall bushings with pre-assembled fixed earthing terminals

The M10 wall bushings are pre-assembled and supplied in the exact wall thickness. Time-consuming adjustments are not necessary.

Fixed earthing terminal: V4A stainless steel,  
connection axe 10 mm: stainless steel

Art.Gr.  
**520**

Wall thickness	Art. no.	Weight/pc.	Price/pc.
200 mm	<b>100444</b>	0.40 kg	<b>€40.00</b>
240 mm	<b>100446</b>	0.42 kg	<b>€41.40</b>
250 mm	<b>100448</b>	0.43 kg	<b>€41.50</b>
300 mm	<b>100450</b>	0.46 kg	<b>€42.55</b>
350 mm	<b>100452</b>	0.49 kg	<b>€43.00</b>
365 mm	<b>100454</b>	0.50 kg	<b>€43.40</b>
400 mm	<b>100456</b>	0.52 kg	<b>€45.00</b>



# M10 connection axis "Solo" for wall bushings

Stainless steel, diameter 10 mm, M10 thread at both ends, length of thread 12 mm

Art.Gr.  
**521**

Wall thickness	Art. no.	Weight/pc.	Price/pc.
200 mm	<b>100410</b>	0.07 kg	<b>€9.40</b>
240 mm	<b>100415</b>	0.10 kg	<b>€11.55</b>
250 mm	<b>100420</b>	0.10 kg	<b>€12.50</b>
300 mm	<b>100425</b>	0.14 kg	<b>€13.50</b>
350 mm	<b>100430</b>	0.17 kg	<b>€14.00</b>
365 mm	<b>100435</b>	0.18 kg	<b>€14.60</b>
400 mm	<b>100440</b>	0.20 kg	<b>€15.20</b>

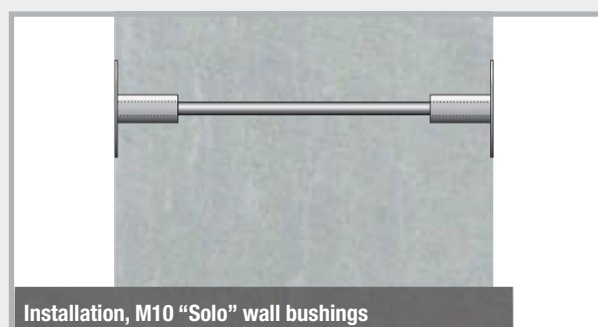
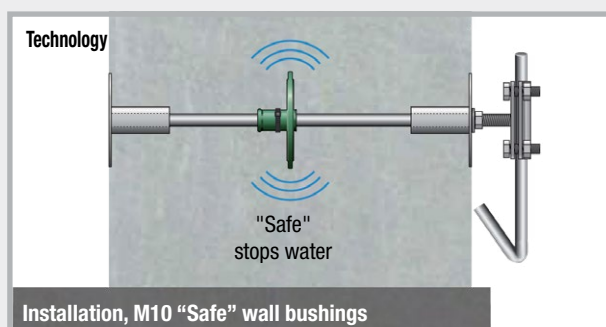

## **NEW!** Wall bushings (N)

For subsequent installation of earthing conductors in borehole  $\varnothing$  14 mm or distance tube. Threaded rod with fixed/loose flange made of V4A stainless steel, connecting clamp and nuts made of galvanised steel.

Art.Gr.  
**534**

Wall thicknesses	Art. no.	PU	Weight per pc.	Price per set
100-300 mm	<b>100310</b>	1 set	0.66 kg	<b>€45.50</b>
300-500 mm	<b>100315</b>	1 set	0.80 kg	<b>€47.20</b>

Inside connection options: Round conductors with pre-installed multi-purpose connecting clamp; flat conductors with double clamp page 10: This clamp can be installed in place of the multi-purpose connecting clamp at the construction site.

**Inside connection**

**Outside connection M12**

Outside connection options: Cross clamp M12, page 18; M12 "Solo" axes page 17

Description	Art. no.	PU	Weight/pc.	Price/pc.
<b>Connection terminal for wall bushing (N), galvanised</b> Connection: Threaded rod on multi-purpose connecting clamp, M10 screw, for round conductors 8-10 mm, with borehole $\varnothing$ 13 mm	<b>100181</b>	1 pc.	0.14 kg	<b>€5.00</b>

## Gasket insert for round conductors, core drill hole 50 mm

Pressure water-tight lead-in with the MASTER-RING gasket insert

Art.Gr.  
**440**

Art. no.	Description	PU	Weight/pc.	Price/pc.
<b>120080</b>	<b>Gasket insert for round conductors 8 + 10 mm,</b> Core drill hole $\varnothing$ 50 mm, Medium pipe 6-12 mm	1 pc.	0.38 kg	<b>€52.10</b>

Discount according to product group 4

## Wall bushing, flexible

Flexible wall bushing M10

for height-offset and side-shifted offset positioning of earthing connections,  
fixed earthing terminal in V4A stainless steel, steel cable Ø 10 mm

Art.Gr.  
520

Art. no.	Description	PU	Weight/pc.	Price/pc.
100660	<b>Wall bushing, flexible 600 mm,</b> 2 x fixed earthing terminal with connecting clamp 1 x steel cable length 600 mm	1 pc.	0.70 kg	€55.00
100662	<b>Wall bushing, flexible 1200 mm,</b> 2 x fixed earthing terminal with connecting clamp 1 x steel cable length 1200 mm	1 pc.	0.93 kg	€60.00

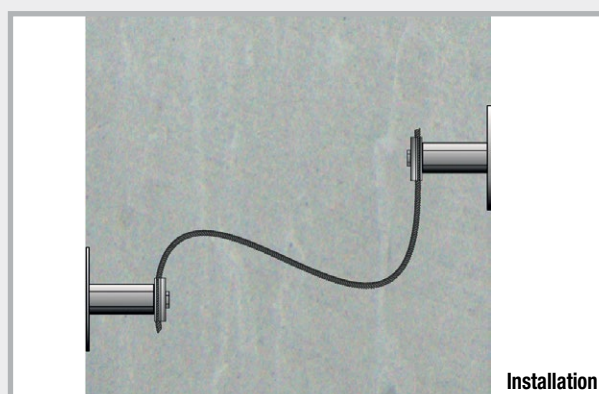

## Wall bushing, flexible "Safe"

Flexible wall bushing M10,

sealed pressure water-tight with RONDO EFP,

for height-offset and side-shifted offset positioning of earthing connections

Art.Gr.  
520

Art. no.	Description	PU	Weight/pc.	Price/pc.
100670	<b>Wall bushing, flexible 600 mm "Safe"</b> 2 x fixed earthing terminal with connecting clamp and RONDO EFP 1 x steel cable length 600 mm	1 pc.	0.77 kg	€65.90
100672	<b>Wall bushing, flexible 1200 mm</b> 2 x fixed earthing terminal with connecting clamp and RONDO EFP 1 x steel cable length 1200 mm	1 pc.	1.00 kg	€71.50

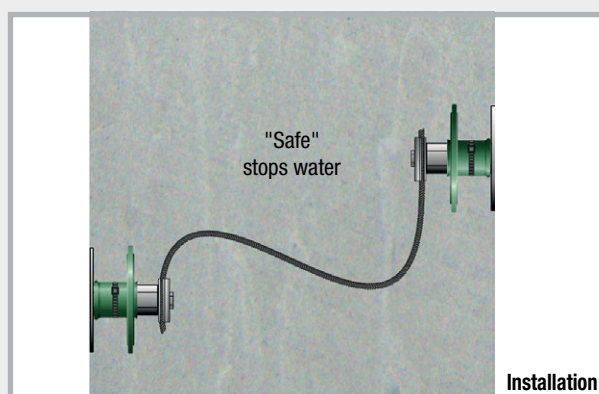



## Fixed earthing terminal M12

to connect the equipotential bonding conductors to the ring earth electrode, reinforcement and lightning protection system

Art.Gr.  
**523**



Art. no.	Description	PU	Weight per carton	Price per pc.	
100300	Fixed earthing terminal M12, V4A stainless steel, with yellow protective cap, Connection M12	1 carton of 10 pcs.	2.00 kg	€24.50	
100304	Fixed earthing terminal M12 "Safe" with yellow protective cap and waterstop, Connection M12	1 carton of 10 pcs.	2.40 kg	€33.15	
100308	Connecting plate 40 x 4 mm, incl. screw M12 x 25	1 carton of 10 pcs.	1.90 kg	€5.00	
100312	Fixed earthing terminal M12 with connecting plate and yellow protective cap, Connection M12	1 carton of 10 pcs.	3.90 kg	€29.50	
100316	Fixed earthing terminal M12 "Safe" with connecting plate and yellow protective cap, Connection M12	1 carton of 10 pcs.	4.30 kg	€38.15	

### Technology

Art. no. 100300

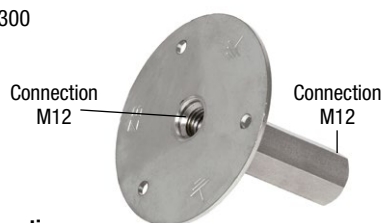

Connection options

Art. no. 100316

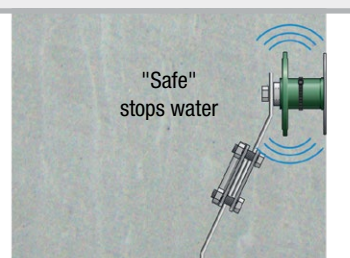

Installation

## M12 "Solo" axes for fixed earthing terminal

Art.Gr.  
**524**

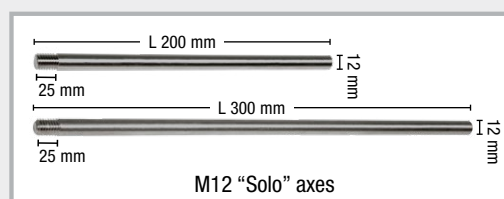

M12 "Solo" axes

Art. no.	Description	PU	Weight/carton	Price/pc.
101170	galvanised, length 200 mm	1 carton of 50 pcs.	8.50 kg	€5.40
101172	galvanised, length 300 mm	1 carton of 50 pcs.	13.00 kg	€6.60
101174	V4A stainless steel, length 200 mm	1 carton of 50 pcs.	9.00 kg	€11.10
101176	V4A stainless steel, length 300 mm	1 carton of 50 pcs.	13.00 kg	€12.10

## M12 "Safe" axes for pressure water-tight fixed earthing terminal



Art.Gr.  
524

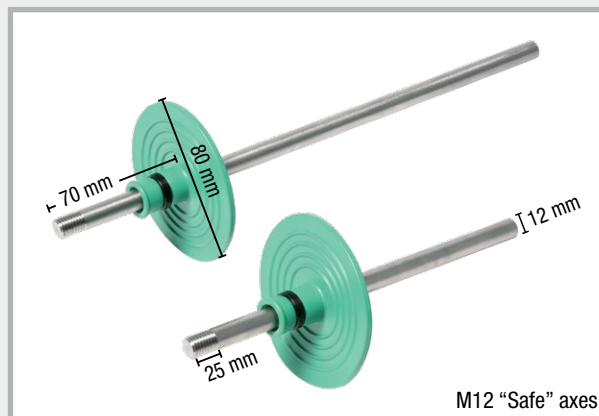

M12 "Safe" axes

Art. no.	Description	PU	Weight/pc.	Price/pc.
101180	galvanised, length 200 mm	1 pc.	0.20 kg	€12.60
101182	galvanised, length 300 mm	1 pc.	0.29 kg	€14.00
101184	V4A stainless steel, length 200 mm	1 pc.	0.20 kg	€19.60
101186	V4A stainless steel, length 300 mm	1 pc.	0.29 kg	€20.70

## Crossclamps for fixed earthing terminals M12

Art.Gr.  
525

Art. no.	Description	PU	Weight/carton	Price/pc.
100460	<b>Cross clamp for fixed earthing terminal M12, galvanised,</b> M12 thread, thread length 70 mm, for round conductors Ø 8 + 10 mm and flat conductors up to 40 mm	1 carton of 10 pcs.	4.20 kg	€13.60
100462	<b>Cross clamp for fixed earthing terminal M12, V4A stainless steel,</b> M12 thread, thread length 70 mm, for round conductors Ø 8 + 10 mm and flat conductors up to 40 mm	1 carton of 10 pcs.	3.45 kg	€20.70
100464	<b>Cross clamp for fixed earthing terminal M12, V4A stainless steel</b> M12 thread, thread length 200 mm, for round conductors Ø 8 + 10 mm and flat conductors up to 40 mm	1 carton of 10 pcs.	4.50 kg	€28.15

Art. no. 100460 + 100462

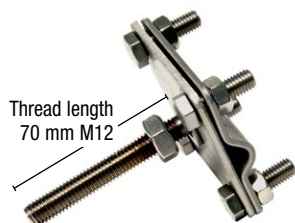

Art. no. 100464



## M12 “Safe” wall bushings with fixed earthing points pre-assembled

The M12 wall bushings are pre-assembled and supplied in the exact wall thickness.

Time-consuming adjustments are not necessary.

Fixed earthing terminal: stainless steel V4A,

connection axes 12 mm: stainless steel

incl. connecting plate 4 x 40 mm

Art.Gr.  
526

Wall thickness	Art. no.	Weight/pc.	Price/pc.
200 mm	<b>100334</b>	0.68 kg	<b>€66.30</b>
240 mm	<b>100336</b>	0.72 kg	<b>€67.50</b>
250 mm	<b>100338</b>	0.73 kg	<b>€67.90</b>
300 mm	<b>100340</b>	0.78 kg	<b>€69.50</b>
350 mm	<b>100342</b>	0.82 kg	<b>€71.20</b>
365 mm	<b>100344</b>	0.83 kg	<b>€71.60</b>
400 mm	<b>100346</b>	0.87 kg	<b>€73.00</b>

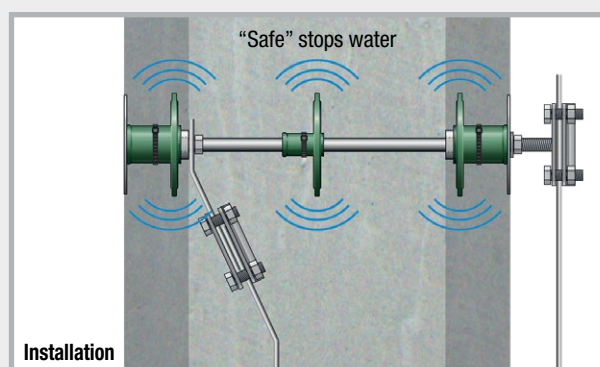
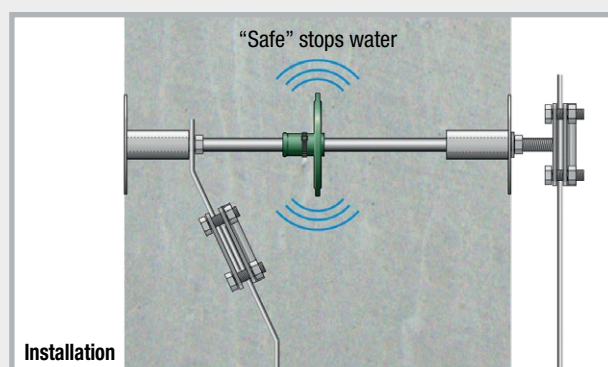
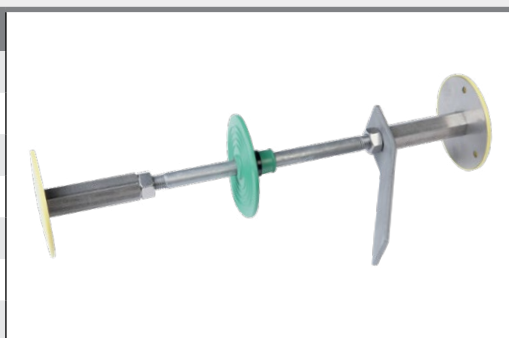

## M12 “DW Safe” wall bushings with fixed earthing points pre-assembled

The M12 wall bushings are pre-assembled and supplied in the exact wall thickness.

Time-consuming adjustments are not necessary.

Fixed earthing terminal: stainless steel V4A,

connection axes 12 mm: stainless steel

incl. connecting plate 4 x 40 mm

Art.Gr.  
526

Wall thickness	Art. no.	Weight/pc.	Price/pc.
200 mm	<b>100348</b>	0.76 kg	<b>€87.30</b>
240 mm	<b>100350</b>	0.80 kg	<b>€88.60</b>
250 mm	<b>100352</b>	0.81 kg	<b>€89.00</b>
300 mm	<b>100354</b>	0.85 kg	<b>€90.90</b>
350 mm	<b>100356</b>	0.90 kg	<b>€92.80</b>
365 mm	<b>100358</b>	0.91 kg	<b>€93.20</b>
400 mm	<b>100359</b>	0.94 kg	<b>€94.80</b>



# M12 connection axis "Solo" for wall bushings

Stainless steel, diameter 12 mm,  
M12 thread at both ends, length of thread 45 mm,  
incl. 2 lock nuts

Art.Gr.  
**524**

Art. no.	Wall thickness	PU	Weight per pc.	Price per pc.
100320	200 mm	1 pc.	0.10 kg	€10.65
100322	240 mm	1 pc.	0.14 kg	€12.00
100324	250 mm	1 pc.	0.15 kg	€12.40
100326	300 mm	1 pc.	0.19 kg	€14.20
100328	350 mm	1 pc.	0.24 kg	€16.10
100330	365 mm	1 pc.	0.25 kg	€16.60
100332	400 mm	1 pc.	0.28 kg	€18.15



# Fixed earthing terminal M16 and accessories

to connect the equipotential bonding conductors to the foundation earth electrode, reinforcement and lightning protection system

Art. no.	Description	PU	Weight per pc.	Price per pc.
100455	Fixed earthing terminal M16, V4A stainless steel, without axis, with yellow protective cap, Connection M16 <span style="float: right;">Art.Gr. 527</span>	1 carton of 10 pcs.	1.70 kg per carton	€23.90
100461	Fixed earthing terminal M16, V4A stainless steel, with flexible connection conductor, Connection conductor CU/SN 95 mm <sup>2</sup> , Conductor length 400 mm <span style="float: right;">Art.Gr. 527</span>	1 pc.	0.66 kg	€149.95
100458	Cross clamp for fixed earthing terminal M16, V4A stainless steel, M16 thread, Thread length 30 mm, for round conductors Ø 8 + 10 mm and flat conductors up to 40 mm <span style="float: right;">Art.Gr. 528</span>	1 carton of 10 pcs.	3.10 kg per carton	€24.00

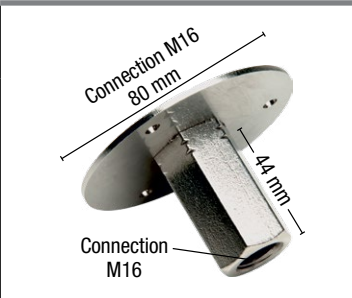
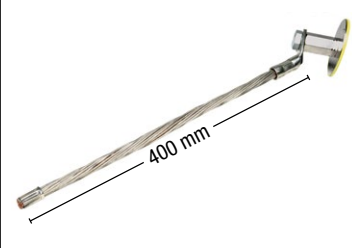
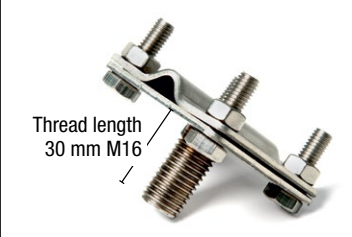
Art.Gr.  
**529**

# Accessories for fixed earthing terminal

Art. no.	Description	PU	Weight per pc.	Price per pc.	
<b>100198</b>	<b>Plastic foam for fixed earthing terminal</b> , self-adhesive on one side, Ø 76 mm, thickness 20 mm	1 bag of 10 pcs.	0.08 kg	<b>€1.50</b>	
<b>100196</b>	<b>Fixing spider for fixed earthing terminal</b> , steel/bright	1 pc.	0.12 kg	<b>€9.70</b>	

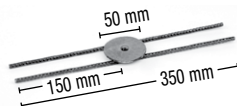

**1**  
Remove protective cap of fixed earthing terminal



**2**  
Stick on plastic foam

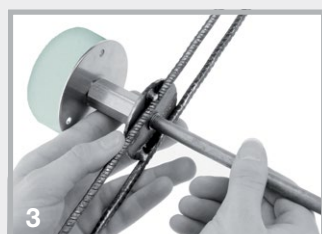

**3**  
Screw axis through the fixing spider and fasten fixed earthing terminal

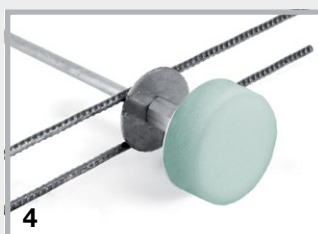

**4**  
Installation complete

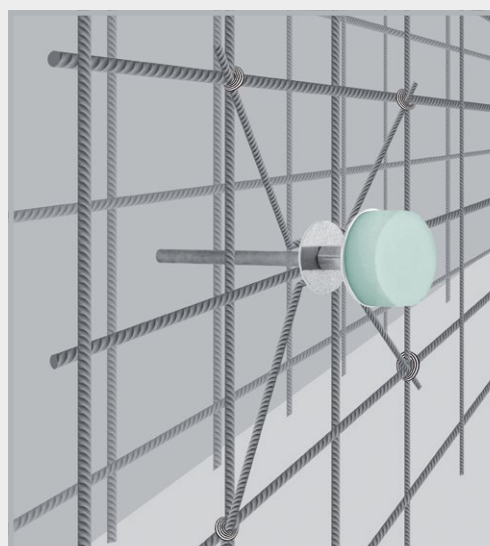



Fixed earthing terminal with fixing spider on the reinforcement

# FIX formwork aid

## **NEW!** Fastening systems for fixed earthing terminals in precast concrete plants

Fastening to steel formworks using the FIX Magnet

Art.Gr.  
**420**

Art. no.	Description	PU	Weight/pc.	Price/pc.	
<b>091410</b>	<b>FIX Magnet</b> for formwork aid Power Magnet for all FIX formwork aids, incl. screw and wing nut	25 pcs.	0.14 kg	<b>€32.80</b>	
<b>090804</b>	<b>FIX EFP formwork aid</b> for fixed earthing terminals M10/12 and M12 Cone height 11 mm	25 pcs.	0.03 kg	<b>€5.00</b>  Discount according to product group 4	

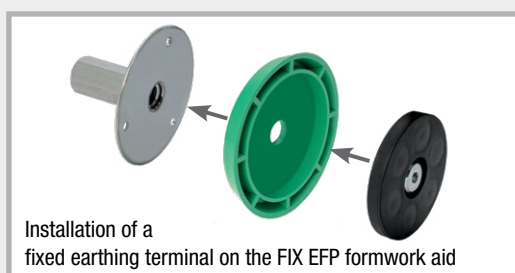

Installation of a fixed earthing terminal on the FIX EFP formwork aid

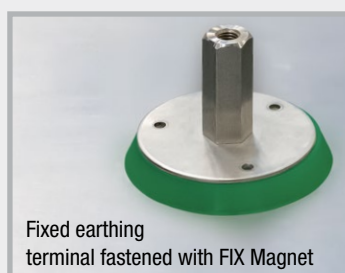

Fixed earthing terminal fastened with FIX Magnet



Option for connection to the fixed earthing terminal, for example with axis and clamp

# MultiCap

Protective cap  
to DIN 18014

## PVC protective cap for round and flat conductors

Art.Gr.  
**530**



Art. no.	Description	PU	Weight/bag	Price/pc.
100500	<b>MultiCap</b> , colour: yellow, area of application: round conductor: 8 + 10 mm flat conductor: 30 x 3.5 mm    40 x 4.0 mm 30 x 3.0 mm    40 x 5.0 mm	1 bag of 100 pcs.	5.15 kg	<b>€1.20</b>

### Technical data

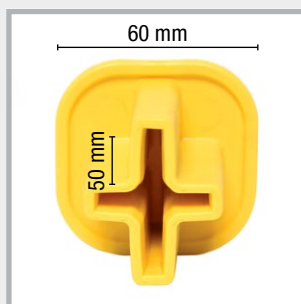

Material: PVC,  
 Large labelled safety cap,  
 60 x 60 mm,  
 long mounting slot  
 50 mm

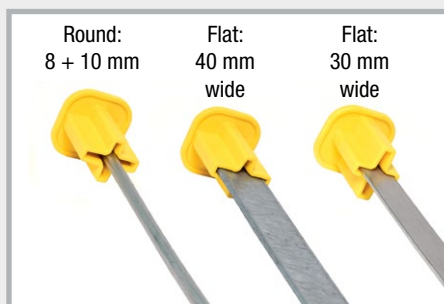

Round: 8 + 10 mm  
 Flat: 40 mm wide  
 Flat: 30 mm wide



MultiCap can be used universally



### Description

- No risk of injury
- Simply plug on
- Yellow signal colour
- One protection cap for 6 sizes

Excerpt from DIN 18014

Foundation earth electrode:

For safety reasons, the terminal lugs must be prominently marked during the construction phase.

# Terminal lugs

Round conductor rods, bevelled

Art.Gr.  
531

Art. no.	Description	Length	PU	Weight per bundle	Price per pc.
100555	V4A stainless steel round conductor Ø 10 mm	1.50 m	1 bundle of 10 pcs.	9.40 kg	€17.60
100560	V4A stainless steel round conductor Ø 10 mm	2.00 m	1 bundle of 10 pcs.	12.50 kg	€23.00
100565	V4A stainless steel round conductor Ø 10 mm	2.50 m	1 bundle of 10 pcs.	15.70 kg	€28.00
100570	V4A stainless steel round conductor Ø 10 mm	3.00 m	1 bundle of 10 pcs.	18.60 kg	€32.60



## RONDO Standard

Sealing collars for lightning protection wire and earthing strap



RONDO sealing collars form pressure water-tight seals for lightning protection wires and earthing straps passing through concrete walls, floor slabs and shafts.

Art.Gr.  
400



Art. no.	Description	PU	Secondary packaging	Weight per pc.	Price per pc.
090890	RONDO RO 10, for lightning protection conductors Ø 8 + 10 mm	1 pc.	1 carton of 100 pcs.	0.12 kg	€21.20
090892	RONDO RO flat, for earthing strap 30x3.5 + 30x3.0 mm	1 pc.		0.18 kg	€23.40
090988	RONDO EFP, for hexagon fixed earthing terminal	1 pc.	1 bag of 25 pcs.	0.04 kg	€7.00



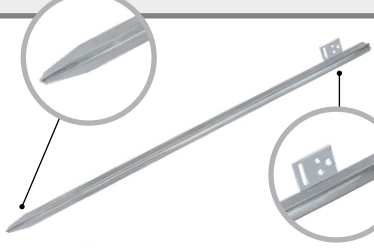
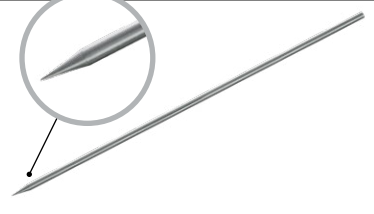
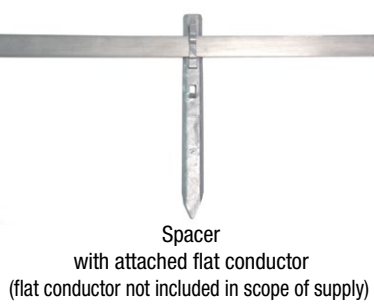
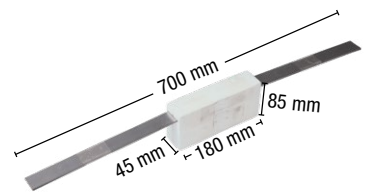

The sealing collars are supplied with fastening straps, ready for installation

## Accessories

Art. no.	Description	PU	Weight per pc.	Price per pc.	
100165	<b>Profiled earth rod, Length: 1.5 m,</b> galvanised, cross profile 50 x 50 mm, with terminal lug	1 pc.	3.40 kg	€23.50	
<b>NEW!</b> 100206	<b>Earth rod for the construction site, Length 1.2 m, Ø 20 mm,</b> galvanised, with impact tip, Connection with clamps from the earth rod range	1 pc.	2.86 kg	€15.20	
100170	<b>Spacer for foundation earth electrode,</b> galvanised, for round connector Ø 8-10 mm, earthing strap 30 x 3.5 mm, length 280 mm, installation spacing 1-1.5 m	1 carton of 100 pcs.	9.80 kg per carton	€2.40	 Spacer with attached flat conductor (flat conductor not included in scope of supply)
100176	<b>Expansion strip with polystyrene body, V2A stainless steel,</b> for routing of foundation earth electrode through expansion joints	1 pc.	0.70 kg	€46.50	 700 mm 45 mm 180 mm 85 mm

## Anti-corrosive tapes

for wrapping of overground and underground connections

Art. no.	Description	PU	Weight per roll	Price per roll	
100190	<b>Anti-corrosive tapes,</b> Roll length 10 m certified by DVGW Size: 1.5 x 50 mm	1 carton of 24 rolls	0.71 kg	€10.65	
100193	Size: 1.5 x 100 mm	1 carton of 12 rolls	1.20 kg	€21.30	

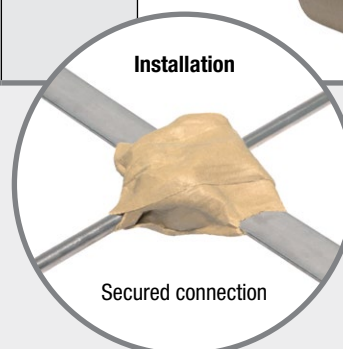



# Earth rod

for use in earthing systems

Art.Gr.  
533

Art. no.	Design	PU	Weight per pc.	Price per pc.	
100205	<b>Earth rod for the installation of earthing systems, galvanised,</b> Length 1500 mm, Ø 20 mm	1 pc.	3.60 kg	<b>€23.60</b>	
100210	<b>Earth rod for the installation of earthing systems, V4A stainless steel,</b> Length 1500 mm, Ø 20 mm	1 pc.	3.70 kg	<b>€92.90</b>	 The earth rods have a drilled hole on one side and a pin on the other. This produces a self-closing coupling.
100215	<b>Impact tip for driving in the first earth rod, bright steel</b>	1 pc.	0.04 kg	<b>€11.30</b>	
100216	<b>Drive-in aid for earth rod, bright steel</b>	1 pc.	0.48 kg	<b>€19.40</b>	
100218	<b>Connecting clamp for earth rod, galvanised,</b> heavy duty version with M10 screws for round conductors Ø 8 + 10 mm and flat conductors up to 40 mm	1 pc.	0.38 kg	<b>€6.70</b>	
100217	<b>Connecting clamp for earth rod V4A stainless steel,</b> heavy duty version with M10 screws for round conductors Ø 8 + 10 mm and flat conductors up to 40 mm	1 pc.	0.30 kg	<b>€17.50</b>	 Connecting clamp installed

## Basic principles of the installation of lightning protection conductors and connectors

### FOUNDATION EARTH ELECTRODE

Installation location: In the concrete of the foundation and floor slab with minimum 5 cm concrete cover on all sides

Material: Galvanised or non-galvanised steel as flat conductor 30 x 3.5 mm or round conductor DN 10 mm

### CONNECTION PARTS ON FOUNDATION EARTH ELECTRODE

Installation location: In subsoil

Material: A4 stainless steel material grades 1.4401, 1.4404, 1.4571  
Flat conductor 30 x 3.5 mm or round conductor DN 10 mm

### RING EARTH ELECTRODE AND CONNECTION PARTS ON RING EARTH ELECTRODE

Installation location: Outside the foundation in the subsoil

Material: A4 stainless steel material grades 1.4401, 1.4404, 1.4571 as  
30 x 3.5 mm flat conductor or DN 10 mm round conductor

**Galvanised material is not permitted in this area**

### CONNECTORS

Installation location: In subsoil, connector made of A4 stainless steel, galvanised in foundation

Description: Wedge connectors are not permitted: unless installed in non-vibrated concrete  
4 x M6 screws above ground only and for arrester lines and down conductors  
4 x M8 or 2 x M10 screws and M10 multi-purpose connecting clamp for use in the following areas: subsoil, concrete, above ground, down conductors and arrester lines.

**DIN STANDARDS** DIN EN 62561-1 and 62561-2

**COSTS** The cost of stainless steel round conductors is up to 33% less than stainless steel flat conductors. The round conductor, which can be installed as an alternative to the flat conductor, is easier to handle and therefore has a significantly higher workability.

# Shipping costs for deliveries ex works

## Parcel shipment in Europe

Country	Belgium Netherlands Luxembourg Czech Republic	Denmark Sweden Finland Austria France	Slovakia Slovenia Croatia Poland	Italy Northern Ireland Republic of Ireland Spain Portugal Greece	Switzerland Norway Liechtenstein	Estonia Latvia Lithuania Bulgaria Romania Hungary	England Wales Scotland
Up to 15 kg including packaging	€21.00	€26.00	€28.00	€28.00	€45.00	€31.00	€34.00
Up to 30 kg including packaging	€35.00	€38.00	€35.00	€39.00	€55.00	€42.00	€45.00

Island deliveries available on request

Delivery time maximum 5 working days for European countries

## Parcel shipment with Express Europe

Country	Belgium Netherlands Luxembourg Czech Republic	Denmark Sweden Finland Austria France	Slovakia Slovenia Croatia Poland	Italy Northern Ireland Republic of Ireland Spain Portugal Greece	Switzerland Norway Liechtenstein	Estonia Latvia Lithuania Bulgaria Romania Hungary	England Wales Scotland
Up to 30 kg including packaging	Generally available on request						

Coordinate express deliveries with our sales team.

The feasibility of every express delivery must be checked and confirmed.

There may be higher parcel costs as we have to charge for the volume weight, which may differ from the actual weight.







# Conditions of Sale

As of 01/03/2023

The following conditions apply to all quotations and sales. The Buyer accepts them by acceptance of our quotations/invoices.

## 1. Quotations, recommendations, advice

Our quotations are valid in case of immediate acceptance only, otherwise they are without obligation. Stock information is given without any commitment. Samples and specimens are for guidance only and without any commitment. Recommendations and advice are given to our best knowledge, but without obligation. We will not be liable due to defaulted or insufficient advice, regardless of whether or not the Buyer had asked for advice.

The customer declares unequivocally by accepting the purchase contract that the items and any replica thereof will not be used, in whole or in part, in connection with the development, manufacture, handling, operation, maintenance, storage, detection, identification or dissemination of chemical, biological, radiological or nuclear weapons/other explosive devices or the development, production, maintenance or stockpiling of missiles/other systems capable of delivering such weapons, or the development, production, handling, operation, maintenance or stockpiling of cluster munitions or anti-personnel landmines or human rights violations.

## 2. Charge

We will always charge you at our prices valid on the day of delivery, freight forward from our warehouse, plus statutory value added tax, unless otherwise agreed and specified.

All separately contracted prices for goods, agreed upon at a time other than the delivery date, are calculated based on the purchase prices at the time the offer was prepared, if there is no express agreement to the contrary. If, in the time from when the contract was concluded until delivery, the purchase prices stipulated on the market increase compared to the purchase prices stipulated at the time of the offer, the price to be paid for the affected goods will change.

## 3. Shipment and transfer of risk

The Vendor effects shipment for the Buyer with due care. Liability, however, is limited to intent and gross negligence. The goods are transported by a parcel delivery company or forwarding agent. The goods are insured according to the relevant conditions of the carrier and the scope of the carrier's insurance policy. If the Buyer collects, the risk shall transfer to the Buyer when the goods are handed over. The following applies to domestic deliveries: Deliveries made free of charge are sent as DAP shipments under the rules of Incoterms 2020. Domestic deliveries made ex works are organised and dispatched by us, the goods are made available to the customer in the same manner as deliveries made free of charge. The Buyer must provide a suitable unloading facility. Any additional or extra cost for e.g. a second delivery shall be borne by the Buyer. The costs of dispatch are passed on to the customer, otherwise the risk is transferred as soon as the goods are made available to the customer at a designated location.

To other European countries and all countries outside the EU the goods are provided according to the rules of the current Incoterms 2020<sup>®</sup>. An Incoterm is chosen in each individual case in consultation with the Buyer.

## 4. Delivery

Periods of delivery that have been agreed upon are approximate only, unless a fixed date has been agreed in writing. Should we have not been able to deliver even after having been granted an additional respite of min. two weeks in written form, the Buyer is entitled to withdraw from the contract. Other claims arising from delayed delivery are inadmissible. Acts of God like strikes, plant closures, plant interruptions, transportation problems due to lack of vehicles or containers, railway and road blocks as well as all events beyond our control shall exempt us from our delivery commitments for the duration of the obstacles.

## 5. Return of goods

Goods may be returned with prior consent of MASTERTEC GmbH & Co. KG only. Goods which are not defective will be accepted in impeccable original condition only. 15% of the value of the goods, but minimum €25 will be deducted from the credited amount. Return shipments sent freight collect will not be accepted. The return shipment is effected at the buyer's risk.

## 6. Payment

The terms of payment are based upon an agreement. Should a cash discount be granted, the pre-condition is that payment of all previous invoices is settled. The cash discount is granted on the net invoice amount only. Default shall occur without prior reminder if the period allowed for payment is exceeded or in case of incomplete payment. We are entitled to charge default interest of min. 3% above the relevant bank rate of the German Central Bank as of the due date, irrespective of any other claims. Should the Buyer's creditworthiness turn out to be insufficient after conclusion of the contract, the Vendor is entitled to demand – at his own option – advance payment or provision of security for due or undue claims from all existing contracts and to refuse fulfillment until receipt of the advance payment or provision of security for due or undue claims from all existing contracts and to refuse fulfillment until receipt of the advance payment or provision of security.

## 7. Retention of title

Goods remain our property until receipt of complete payment (in case of payment by cheque/bill of exchange until final encashment). The title will not pass to the Buyer before all debts arising from consignments have been paid. For open accounts the retention of title serves as a security for our balances receivable.

The Buyer is entitled to sell the goods in the orderly course of business. The goods must neither be pledged nor assigned by way of security. The Buyer shall inform us without delay of any other interference with our rights by third party. If the Buyer sells the goods delivered by us, he assigns to us his receivables resulting from the sale including all accessory rights until complete discharge of liabilities to us.

Goods under retention of title shall always be processed to the exclusion of any acquisition of title under § 950 of the German Civil Code. Processing is done by the Buyer on the Vendor's behalf but without incurring any commitment on the Vendor's part.

In the event of any processing by the Buyer, the Vendor shall have the right of co-title to the new product to the amount of the invoice value of the processed goods under retention of title.

## 8. Notice of defect and warranty

The Buyer can file complaints only before use, sale or mixing of the goods. Complaints are to be filed within 8 days after receipt of the goods in written form. Notice of defects detected after that period must be filed to us immediately, i.e. without undue delay, in writing and can be recognised only if detection was impossible by inspection within a period of 8 days after receipt. Complaints filed after one month after receipt of the goods are not admissible under any circumstances.

In any case, defects detectable by proper inspection before use, sale or mixing of the goods can only be claimed if the rejected goods are still in the packaging used by us.

In case of a justified complaint, the Buyer has the right of exchange of the goods. Claims for cancellation of sale, reduction of the purchase price or damages as well as claims for compensation for any consequential damage are not admissible.

## 9. Damages

Any claims for damages by the Buyer that may arise directly or indirectly from ordering, delivery or use of our goods, regardless of the legal basis, are inadmissible, provided that we, our assistants, or our agents have not caused the damage by gross negligence or intention.

In case of damage caused by gross negligence, the claim for damages of a Buyer who is a merchant is limited to the compensation of the anticipated damage. Any claim for damages because of delayed performance or impossibility of performance due to slight negligence from a Buyer who is not a merchant will not be considered.

## 10. Place of fulfillment and jurisdiction

The place of fulfillment for deliveries (also for deliveries free domicile) is the relevant place of shipment, for payment Oberhaid as the Vendor's place of business. The place of jurisdiction for all parties, also for suits upon bills or cheques is Bamberg. The Vendor is free to choose another admissible place of jurisdiction.

**Items made to order (materials from object-related production) are barred from repurchase.**

### **Notes on the price list**

All prices exclusive of VAT. We cannot be held responsible for misprints.  
The items pictured may differ in appearance from the products delivered.

Oral and written advice is non-binding.

All prices are non-binding recommended sales prices.

The prices charged are those valid on the day of dispatch. No part of this publication may be reproduced without our prior permission.

**LIGHTNING PROTECTION CONDUCTORS**

**CONNECTORS**

**CONNECTING CLAMPS**

**FIXED EARTHING TERMINALS**

**WALL BUSHINGS**

**EARTH RODS**

**MASTERTEC** GmbH & Co. KG  
Special articles for reinforced concrete construction

Gewerbegebiet Unterhaid  
Im Maintal 13  
96173 Oberhaid, Germany  
Tel. +49 (0) 9503 / 5047-0

[info@mastertec.eu](mailto:info@mastertec.eu)  
[www.mastertec.eu](http://www.mastertec.eu)

We are a member

